

Carolina Seating Price List

June 2, 2018

WARRANTY, TERMS & CONDITIONS 1 - 4

SHIPPING & ORDERING 2 - 4

FLAME RETARDANT INFORMATION 5

COM & COL INFORMATION 6 - 7

FINISH OFFERING. 8 - 10

PRODUCT CARE. 11

QUICKSHIP. 12

ENVIRONMENTAL INFORMATION 13

PRODUCT REFERENCE MODIFICATION LIST 14

SEATING

Lounge 17 - 85

Modular 86 - 113

Guest/Multi-Use 114 - 140

Multiple 141 - 179

Stools 180 - 190

Task 191 - 197

Patient. 198 - 221

Bariatric 222 - 234

Recliners 235 - 261

Sleepers 262 - 276

Accessories 277 - 282

OCCASIONAL TABLES 283 - 300

WARRANTY, TERMS & CONDITIONS

OUR COMMITMENT TO OUR CUSTOMER

OFS and Carolina products are manufactured with careful attention to detail and with an on-going commitment to achieve a level of quality that is free of defects in materials and workmanship, given normal use and proper care. In an effort to stand by this philosophy, OFS and Carolina, hereby warrants, to the original purchaser of the product and from the original date of purchase.

OFS and Carolina products warrant to 12 years on single-shift applications with exceptions noted below.

Carolina products warrant to 12 years on multi-shift applications with exceptions noted below.

OFS and Carolina will repair or replace, at our discretion without charge to the original purchaser, any product or part thereof which fails as the result of such a defect during the warranty period. In the event any product has to be returned to the factory for verification of a complaint, it must be pre-authorized by the factory and shipped prepaid along with written information containing the name of the original purchaser, original invoice number, and a copy of the original purchase order. If the product is returned to an authorized dealer for repairs, OFS and Carolina will provide the materials to repair the product free of charge, including transportation cost.

EXCEPTIONS TO THE 12 YEAR SINGLE-SHIFT WARRANTY:

Category	Years Under Warranty					
	1	2	3	5	10	Lifetime
ANCILLARY AND WORK SPACE						
All drawer glide suspensions						X
All locking mechanisms						X
Base height adjustable mechanism				X		
Casters, Glides, Control Mechanisms and Pneumatic Cylinders		X				X
Foam, Mesh Material		X		X		
WORK CHAIRS	1	2	3	5	10	Lifetime
Foam, Mesh Material		X				
Work Chairs with heavy duty upgrades					X	
CAROLINA	1	2	3	5	10	Lifetime
Foam, Mesh Material		X				
Recliner components, sleeper chair mechanisms and accessories				X		
Recliner mechanisms					X	
Three Position Recliner & wall saver mechanisms				X		
OTHER	1	2	3	5	10	Lifetime
Electrical components/Power Supplies	X					
Remote control projection screen		X				
Task Lights			X			

Warranty does not cover:

- Natural variations in color, grain, or texture of wood, leather and other textiles over which OFS and Carolina has no control.
- Normal aging and wear of textiles, filling materials and finishes are exempted from this warranty.
- Textile color matching, textile puddling, fastness of colors or wearing qualities of any material.
- Slight differences in textile color due to supplier dye lot differences on large orders or on repeat orders placed at later dates from the original order.
- Labor and service not covered under warranty.
- Customer's Own Material (COM/COV/COL) is not covered by the textiles warranty. Any warranty claims for these upholstery materials will fall to the original vendor of the textile. With a broad spectrum of harsh cleaning agents used by facilities, it is recommended that the owner test each textile selection with their specific cleaning methods before ordering.
- OFS or Carolina products or components attached in some manner to any other manufacturer's products or components (i.e. OFS conference tops to another manufacturer's base).
- Damage caused by a transportation company.
- Damage created by loading file drawers with anything other than hanging files.
- Freight or other shipping charges on returned product or parts, labor and service.

WARRANTY, TERMS & CONDITIONS

TEXTILES

OFS and Carolina will evaluate the textile to determine its possible use on our furniture, but this does not warrant or guarantee the performance of the textile. OFS and Carolina warrants the workmanship (cutting, sewing, upholstery fit) of textiles to perform under normal aging and wear when cared for according to cleaning and maintenance guidelines provided by the textile supplier/manufacturer. With a broad spectrum of harsh cleaning agents used by facilities, it is recommended that the owner test each textile selection with their specific cleaning methods before ordering. If any textiles exhibit deterioration, delamination or other failure not associated with the application to OFS or Carolina products or due to cleaning methods, OFS and Carolina will not be responsible for costs associated with recovering or replacement. Textiles on products with a heavy duty upgrade must exceed 100,000 double rubs for the textile workmanship portion of the warranty to apply.

PRODUCT DESIGN & DISCONTINUED PRODUCTS

OFS and Carolina reserves the right to make alterations in design and construction or discontinue products without prior notice. If items are discontinued, OFS and Carolina reserves the right to repair or replace defective components with equivalent components, if available.

LIMITATION OF LIABILITY

Except as otherwise provided, OFS and Carolina make no other warranties, expressed or implied, including but not limited to the warranties of merchantability and fitness for a particular purpose.

Under no circumstances, including but not limited to breach of contract, breach of warranty or negligence, shall OFS and Carolina be liable for lost profits, loss of goodwill, stored data, general, special, consequential or exemplary damages, even if OFS and Carolina had notice of these damages or they were foreseeable. OFS and Carolina shall not be liable for consequential or incidental damages arising from any product defect. OFS and Carolina shall not be responsible for verifying Dealer's or customer's description of needs, data, or the fitness for a particular purpose of goods. OFS and Carolina liability in all cases shall be limited to repair or replacement of the defective parts, or the purchase price of the product. Damages resulting from user modifications, attachments to a product, misuse, abuse, alteration, negligent use, accidents, improper or lack of maintenance and damage in transportation are not covered under this warranty.

This warranty is applicable only to those products actually manufactured by OFS and Carolina. On product furnished by OFS and Carolina, but with components or equipment manufactured by others, including, but not limited to, foam, mechanisms, casters and textiles, the written warranty, if any, of the manufacturer is assigned to the purchaser.

POSSESSION OF THE PRICE LIST DOES NOT CONSTITUTE AN OFFER TO SELL. WE RESERVE THE RIGHT TO MODIFY PRODUCTS, PRICES OR DISCONTINUE ITEMS WITHOUT PRIOR NOTIFICATION.

ORDERING INFORMATION

All orders should be placed with:

OFS

P.O. Box 100
Huntingburg, IN 47542
800-521-5381 Fax 812-683-7256
order_entry@ofs.com

Carolina

P.O. Box 4398
Archdale, NC 27263
800-763-0212 Fax 336-431-9400
oenc@ofs.com

ORDER MUST INCLUDE

- Company name, address, telephone and fax number
- Contact person
- Authorized signature
- Purchase order number
- Sold to address & ship to address
- Order date
- Requested ship date
- Complete style number
- Fabric/Vinyl/Leather grade, vendor, pattern and color
- Correct Net Dealer pricing
- Any special instructions
- CDA (if applicable)

NOTE: A customer drawing or sketch of the planned configuration in modular applications will facilitate order processing.

PRICES

All prices herein are list prices including delivery to one destination, effective with the date printed on the cover, and supersede all other published price lists. US List Prices are domestic prices only for shipment within the Continental United States. Prices are subject to change without notice, unless quoted in writing. Possession of the price list does not constitute authority to sell or offer for sale OFS and Carolina products.

ACKNOWLEDGMENTS

Orders are acknowledged upon receipt of credit approval. Your acknowledgment is a detailed description of items, prices, shipping information and shipping date. Please read your acknowledgment closely and notify OFS and Carolina immediately of any discrepancies. OFS and Carolina are not responsible for errors on orders placed by phone without written confirmation.

AVAILABILITY

OFS and Carolina are committed to the fastest possible shipment of all products. All other items are available within our normal manufacturing schedule. For information on stock availability, call our customer service hotline 800.521.5381 for OFS and 800.763.0212 for Carolina.

Note: Planned shipping dates may be delayed due to fires, strikes, natural disasters or other causes beyond our control.

QUANTITY ORDERS

Contact your OFS or Carolina Customer Service Representative to verify inventory and production schedules to ensure requested shipment date prior to placing large quantity orders.

DELIVERY AND FREIGHT CHARGES

All shipments are F.O.B. point of shipment, freight prepaid and allowed, excluding fuel surcharges. Shipments outside of the Continental United States are freight prepaid and allowed to port of exit. OFS and Carolina reserve the right to select the most appropriate carrier and routing on all shipments; however, we will try to accommodate requests for your preferred carrier. OFS and Carolina reserve the right to implement a fuel surcharge. Orders of less than \$1500 net will be assessed a handling charge of \$100 net per order. Any charges arising from failure to receive a shipment, rerouting while in transit or carrier storage charges are not included in prices shown. Orders requiring special services are subject to an additional charge.

These services include:

- Reconsignment from original destination to new destination. **\$35 plus \$3.00 per mile net**
- Refused/Returned Freight
 - Freight refused at destination and returned to OFS or Carolina **Double Freight**
 - Freight refused at time of delivery; returned to OFS or Carolina to deliver at a later date **Triple Freight**
- Detention Fees (after 2 hours of waiting) **\$85 net per hour**
- Weekend delivery available Friday after 3:00 p.m. through Sunday night or Holiday **\$600 net per truck**
- Customer Pickup
 - Customer Request for 3rd party to pick up freight at OFS or Carolina terminal **\$125 net**
- Change of Tags/Address/Phone #'s on Shipments **\$35 net**

SPECIAL ORDERS

The OFS and Carolina lines of office furniture are among the most complete in the industry. However, should a particular need arise requiring size modification or customization, contact your Customer Service Representative for a price quotation. Because of the uniqueness of the product, special orders are not subject to cancellation.

CANCELLATION AND ORDER CHANGES

All orders accepted by OFS and Carolina are considered firm and binding and are not subject to cancellation.

WAREHOUSE STORAGE CHARGES

If a shipment is held beyond fourteen (14) calendar days after the order is ready for shipment at your request, a .067% per day (2% per month) storage charge will be assessed. The effective date will be fourteen (14) calendar days after the order is ready for shipment, as long as this date is after the acknowledged ship date. Further, the prices applied to the order will be those prices in effect at time of shipment.

EXTENDED PRODUCTION AND SHIP DATES

Orders placed with OFS and Carolina with extended lead times as requested by you will be subject to price in effect at time of shipment.

DAMAGED MERCHANDISE AND FREIGHT CLAIMS

1. Inspect all cartons for damage and carton quantity. All shipments are delivered to the transportation company in good condition; OFS' and Carolina's liability ceases at this time. Do not refuse merchandise damaged in transit. Instead, enter a claim with the transportation company
2. Record damages and/or shortages on the bill of lading and freight bill. Do not accept the shipment until all shortages are noted on both the bill of lading and the freight bill. Sign only for the items you receive. If you give the delivering carrier a clear receipt for a shipment, the carrier is relieved of further responsibility.
3. If concealed damage is found: Notify the delivering carrier at once and request an inspection. For shipments via Styline Logistics, notify your OFS or Carolina Customer Service Representative. This must be done within fifteen (15) calendar days of delivery. Without this inspection the transportation company will not entertain a claim for loss or damage. If the carrier will not perform the inspection, you should prepare an affidavit that you contacted the carrier, noting the time and date, and that the carrier failed to comply with your request. All shipping cartons and inner packing must be retained for carrier inspection. Do not move the damaged merchandise from the receiving location. It must also be retained for the inspection.

RETURN OF MERCHANDISE

OFS or Carolina will not accept returned merchandise without a signed Return Authorization (RA) issued by our Customer Service Department. All returned merchandise must be properly packaged and cartoned to prevent further damage. Carton must be clearly marked with identifying RA number so that proper credit can be issued. We will consider issuing RAs for the following reasons:

- Manufacturing defect (must be inspected by a OFS or Carolina Sales Representative)
- OFS or Carolina order processing error
- Shipping error
- Duplicate shipments
- Mismarked cartons

All merchandise must be returned within thirty (30) days of the date of the RA to receive credit. Freight damage, signs of usage, missing parts, etc. will be adjusted on the amount of credit to be issued.

REPAIR CHARGES

Reimbursement from OFS or Carolina for repairs must have prior approval.

FINISH

 The patented Euroluxe® finish is a chemically re-engineered Urethane clear coat that preserves the beautiful depth and clarity of OFS and Carolina finishes, but allows for much greater performance with chemical and scratch resistance, as well as the complete elimination of dangerous formaldehyde emissions. The Euroluxe® finish system achieves indoor air quality standards set by LEED and BIFMA furniture emission standards and allows all products to achieve SCS Global Services' Indoor Advantage Gold Certification.

CUSTOM FINISH COLOR

Custom finish matching is available for special requirements. OFS and Carolina must be provided with a suitable 8" x 10" or larger finish sample. However, custom finishes can be developed to meet specific needs. There will be a \$300 net upcharge per order for new custom finishes (waived on projects of \$100,000 net price or more). Custom finish upcharge for repeat or additional orders will be \$150 per order, even when the upcharge was waived on the original project. Custom finish matches are valid for 12 months from sample date. After this time period, custom finishes must be rematched and reapproved for use.

FINISH DISCLAIMER

Some desktop accessories with plastic feet can penetrate or burn the finish. This is not a defect in the finish. Wood is a natural product and minor variations in wood color, grain and texture may be visible even though the pieces are finished at the same time. Also, light finishes when exposed to ultraviolet rays may darken and change color. These are not defects in finish, and merchandise cannot be replaced because of these natural variations.

BIFMA AND ANSI TESTING

OFS and Carolina are members of the Business and Institutional Furniture Manufacturer's Association. Tests developed by BIFMA and approved by the American National Standards Institute (ANSI) determine the strength and durability of casegoods and seating in its everyday use. Although this testing does not serve as a warranty or guarantee, OFS and Carolina products within this price list generally meet or exceed applicable BIFMA and ANSI standards.

MODIFICATION PRICING

Modifications must be clearly designated on customer's purchase order by placing the letters MOD and modification # in front of the model number and noting the modification needed.

Example: MOD#2-4-9622MCT-LC2-EW-G1-G1 with top cut down to 94" wide

Contact your Customer Service Representative for upcharge on drawer configuration changes for traditional casegoods series.

GLIDES

OFS and Carolina utilizes different types of glides in our seating and occasional tables construction, ie; non-marring, non-skid glides, adjustable glides, plastic glides, etc. The type of glide used in a product depends on the products design and typical application. Due to varying flooring materials and our inability to test on all flooring types, **OFS and Carolina assumes no responsibility for floors damaged by glides. For questions regarding glides, or to request specific glides contact Customer Service.**

FABRIC PUDDLING

The content of certain fabrics makes these fabrics susceptible to puddling and wrinkling over which OFS and Carolina have no control. Slight changes in weather and humidity can affect these fabrics. OFS and Carolina will not assume responsibility when this happens.

FABRIC COLOR MATCHING

OFS and Carolina do not guarantee and will not assume responsibility for the fastness of colors or wearing qualities of any material. Because of industry dye lot variations, colors may not match exactly. Any adjustments made will depend upon the fabric manufacturers willingness to stand behind their product.

CUT YARDAGE FABRICS

Cut yardage from any OFS and Carolina Textile partner may be purchased through OFS and Carolina. Contact Customer Service for cut yardage pricing.

DIRECTIONAL FABRICS

Directional fabrics such as plaids, stripes and certain patterns may not meet your expectations due to certain sewing patterns, tufting and contoured shapes of certain styles and models. When required we will upholster to customer specifications but such orders are not subject to return. If you have a question or concern about one of these fabrics, please contact your Customer Service Representative and submit a fabric sample for approval prior to placing an order.

FABRIC APPLICATION

OFS and Carolina will match all fabrics that require matching such as plaids, stripes, or prints. Unless otherwise noted on the customer's purchase order, OFS and Carolina will apply textiles to upholstered items in the manner which we deem to be most appealing. OFS and Carolina take no responsibility for the direction in which textiles are applied unless the desired direction is notes on the customer purchase order. OFS and Carolina reserve the right to reject textiles we deem unsuitable for application on our products.

GUARANTEE

Although every effort is made to select covering materials for wearability as well as appeal, we CANNOT guarantee covers for wearability or colorfastness. We can extend only that guarantee which the supplier extends to us.

FIRE RETARDANT PRODUCTS

California Technical Bulletin 117-2013: All OFS and Carolina upholstered seating products and the resilient filling materials used in the upholstered seating products meet or exceed the requirements of the State of California, Department of Consumer Affairs, Technical Bulletin 117-2013. Compliance with these requirements is indicated by the label attached to the seat bottom.

Flame Retardant Chemicals: All standard OFS and Carolina upholstered seating products are offered with components, as identified in TB117-2013, that are free of flame retardant chemicals. All OFS and Carolina upholstered seating products will indicate Flame Retardant chemical composition in accordance to the labeling requirements of California Senate Bill 1019.

California Technical Bulletin 133: Cal TB 133 is a flammability test for seating products used in public spaces. The testing procedure for Cal TB 133 requires the burning of an entire product since the test is a composite test and not a component test. OFS and Carolina have pretested and certified many different chair styles and upholsteries. If Cal TB 133 certification is required, a burn test may need to be completed with a specific model and upholstery combination. Contact Customer Service for Cal TB 133 approval, pricing and lead times.

OFS and Carolina can not be held liable if purchase order does not indicate a requirement for Cal TB 133 compliance.

Boston Fire Code: Please contact OFS or Carolina Customer Service if compliance is required.

TEXTILES

OFS and Carolina offer an extensive program of graded-in textiles including fabrics, leathers, vinyls, polyurethanes and Cryptons® from the industry's finest sources. While our binders may not include cards from every supplier, we do maintain programs with the following:

NOTE: For a list of current OFS and Carolina grades visit the textiles section of the OFS and Carolina websites at:

ofs.com and carolina.ofs.com

FABRIC PARTNERS

— **ARC-COM**
www.arc-com.com

— **ARCHITEX**
www.architex-ljh.com

— **CAMIRA**
www.camirafabrics.com

— **CARNEGIE**
www.carnegiefabrics.com

— **HELVETIA LEATHER**
www.helvetialeather.com

— **DESIGNTEX**
www.designtex.com

— **GREEN HIDES**
www.greenhides.com

— **MAHARAM**
www.maharam.com

— **MAYER FABRICS**
www.mayerfabrics.com

— **MOMENTUM**
www.themomgroup.com

— **SPRADLING INTERNATIONAL, INC.**
www.spradlingvinyl.com

— **STINSON**
www.cfstinson.com

— **ULTRAFABRICS**
www.ultrafabricsllc.com

COM/ (CUSTOMER'S OWN MATERIAL) & GRADED-IN TEXTILE POLICY

OFS and Carolina will evaluate the fabric to determine if it is possible to use this type of fabric on our furniture, but this does not warrant or determine the performance of the fabric. Any warranty claims for these upholstery materials will fall to the original vendor of the fabric, not OFS or Carolina. With a broad spectrum of harsh cleaning agents used by facilities, OFS and Carolina recommend that the owner test each fabric selection with their specific cleaning methods before ordering

COM/COL ORDERING INSTRUCTIONS

All COM and COL materials must be submitted to OFS and Carolina for preliminary approval prior to shipment of fabric or leather. Approval signifies only that such materials can be applied to the products for which they are intended. Such approval does not constitute any responsibility nor any warranty on the part of OFS or Carolina as to the appearance, behavior or durability of the COM or COL.

1. Send 4" x 4" swatch for approval to: **Carolina, Attn: Customer Service, 1264 Jackson Lake Rd., High Point, NC, 27263**
2. Send a swatch along with the order to: **Carolina, Attn: Customer Service, 1264 Jackson Lake Rd., High Point, NC, 27263**
This sample is used to verify that the correct fabric is received. It is not used for application approval.
3. Specify the COM or COL supplier's company name, pattern, color and number.
4. The COM or COL supplier must include the dealer name and purchase order number on all packing lists.
5. Include application instructions for striped, plaid, patterned or unusually designed fabrics (i.e. direction of stripes) and which face to use on reversible fabrics.
6. Ship COM or COL material prepaid to: **Carolina, 533 Archdale Blvd., Archdale, NC, 27263**

COM and COL orders will be scheduled for production only upon receipt of production yardage. In the absence of a representative sample sent with the purchase order or application instructions, OFS and Carolina will apply the fabric in what it determines to be the best manner and cannot be held responsible after upholstering. **Excess COM/COL materials will be discarded at the discretion of OFS and Carolina unless otherwise instructed by the customer at the time the order is placed.**

COM YARDAGE REQUIREMENTS (RAILROADED FABRICS)

Yardage requirements listed in our price list are based on 54" wide. We can take no responsibility for tailoring, wearability or application of COM covers. OFS and Carolina will not be held responsible for receipt of defective fabrics, as we apply all COM as first quality goods. At no additional charge, OFS and Carolina will pre-approve any COM at the customer's request. The additional yardages are based on 54" wide goods. Please contact Customer Service if goods are less than 54" wide. Though every effort has been made to estimate excess yardage required for stripes and matches, OFS and Carolina takes NO responsibility where additional materials must be ordered..

Repeat	Railroad (RR)	Right Way (RW)	2-Way
1/4"-5"	Add 10%	Add 15%	Add 15%
6"-9"	Add 15%	Add 18%	Add 20%
10"-13"	Add 20%	Add 25%	Add 30%
14"-20"	Add 25%	Add 30%	Add 35%
21"-27"	Add 30%	Add 35%	Add 40%
28"-34"	Add 35%	Add 40%	Add 45%

Repeats larger than 19", fabrics less than 54" wide or fabrics requiring matching (stripes, plaids, prints, large patterns) will require additional yardage based on the fabric used and the item ordered. COM must be a single cut piece. Multiple pieces will require more yardage. A swatch showing one full repeat must be sent for yardage requirement instructions for these special circumstances.

COM APPLICATION

All COM fabrics are cut according to the fabric pattern at the discretion of OFS and Carolina unless otherwise directed by the customer.

COM FIRE RETARDANT PRODUCTS

OFS and Carolina assume no responsibility for the fire retardancy of any COM/COL. Customers are solely responsible for making sure that their COM/COL complies with all applicable codes and regulations.

COL (CUSTOMER'S OWN LEATHER)

COL requirements are based on an average hide size of 50-55 square feet. Please consult the sales office for requirements on sizes different from this. All square footage requirements are based on usable footage. The shape of the hide and the usable footage may make it necessary for us to request more leather after your COL is received. Please note that leather is a natural product and variation in texture is a pleasing quality belonging exclusively to high grade, full top grain leathers. Due to the variation in thickness of leather, OFS and Carolina recommends sending a 4" x 4" swatch for approval. OFS and Carolina approval signifies only that such materials can be applied to the products for which they are intended. Such approval does not constitute any responsibility nor any warranty on the part of OFS and Carolina as to the appearance, behavior or durability of the COL. **Note: Calf hide requirements will vary based on the chair model selected. Please contact the sales office for pattern adaptability confirmation and square footage requirements prior to placing an order.**

ALL STANDARD EUROLUXE® VENEERS

CHERRY

- MOCHA [MMC]
Quartered or Flat Grain Pattern
- MOLASSES [QEC]
Quartered Grain Pattern
- SIENNA [MLC]
Quartered or Flat Grain Pattern

WALNUT

- BURNISHED [BUW]
Quartered or Flat Grain Pattern
- DESERT [DST]
Quartered Grain Pattern
- EBONY [EBY]
Quartered or Flat Grain Pattern
- PORT [MVW]
Quartered or Flat Grain Pattern
- ROOT [MNW]
Quartered Grain Pattern
- TOFFEE [MGW]
Quartered Grain Pattern

MAPLE

- BLONDE [MBM]
Quartered or Flat Grain Pattern
- HONEY [MHM]
Quartered or Flat Grain Pattern

OAK

- LINEN [MRO]
Quartered Grain Pattern
- OSLO [OSL]
Quartered Grain Pattern
- PECAN [PCO]
Quartered Grain Pattern
- STEEL [MGO]
Quartered Grain Pattern

ASH

Only on Eleven Wood by OFS

- BLONDE [MBA]
Quartered Grain Pattern
- HONEY [MHA]
Quartered Grain Pattern
- PECAN [PCA]
Quartered Grain Pattern
- ROOT [NWA]
Quartered Grain Pattern
- STEEL [MGA]
Quartered Grain Pattern

STUDIO VENEERS (10%)

- ARABICA [C2Q]
Quartered Grain Pattern
- SILVER GREY [SVC]
Quartered Grain Pattern
- WHEAT [C2P]
Quartered Grain Pattern
- SALVAGED LINEN [SFO]
Planked Grain Pattern
- SALVAGED ROOT [SFW]
Planked Grain Pattern

ALL WOOD GRAIN LAMINATES

P = HPL 2 = TFL 3 = 3DL

CHERRY

- COGNAC [MGP | VM2 | VM3]
Flat Grain Pattern
- MOCHA [CMP | MC2 | MC3]
Flat Grain Pattern
- MOLASSES [QEP | QE2 | QE3]
Quartered Grain Pattern
- SIENNA [CHP | LC2 | LC3]
Flat Grain Pattern

WALNUT

- BURNISHED [BUP | BU2 | BU3]
Flat Grain Pattern
- KODIAK [KDP | KD2]
Quartered Grain Pattern
- PORT [VMP]
Flat Grain Pattern
- ROOT [NWP | NW2 | NW3]
Quartered Grain Pattern
- TOFFEE [MEP | EN2 | EN3]
Quartered Grain Pattern

MAPLE

- BLONDE [BEP | BE2 | BE3]
Flat Grain Pattern
- HONEY [HNP | MH2 | MH3]
Flat Grain Pattern
- OCHRE [TMP | LM2 | LM3]
Flat Grain Pattern

OAK

- LINEN [COP | CO2 | CO3]
Quartered Grain Pattern
- PECAN [PCP | PC2 | PC3]
Quartered Grain Pattern
- QUARRY [QRP | QR2]
Quartered Grain Pattern
- STEEL [STP | ST2 | ST3]
Quartered Grain Pattern

PAINTS

- BLACK [BLK]
- IRON [IRN]
- WHITE [WHT]

STUDIO PAINTS (10%)

Only on Select Products

- BLUSH [BLUS]
- CIDER [CIDR]
- DIJON [DIJO]
- FALLOW [FALO]
- FERN [FERN]
- MIDNIGHT [MDNT]
- PINE [PINE]
- TUNDRA [TUND]

SOLID COLOR LAMINATES

- BLACK [BLP | BL2 | BL3]
- FROSTY WHITE [FWP | FW2 | FW3]
- GREY [GRP | GR2 | GR3]
- PURE WHITE [RWP | RW2 | RW3]
- SLATE GREY [SGP | SG2]
- WALLABY [WLP | WL2 | WL3]

METAL POWDER COAT COLORS

- BONE WHITE [BWT]
- BUFF [BUF]
- CHALK [CHLK]
- GOLD [SGLD]
- GRAPHITE [GRPH]
- LUSTER GREY [MSL]
- OILED BRONZE [HIP]
- ONYX [BKO]
- POLAR [POLR]
- SOFT BRONZE [SBRZ]
- WARM GREY [HIF]

SOLID SURFACE

- CAMEO WHITE [CWS]
- CONCRETE [CSS]
- DEEP MINK [DMS]
- MODERN WHITE [MWS]

STUDIO POWDER COAT (10%)

Only on Select Products

- CADET [CADT]
- CLOVER [CLOV]
- GOLDENROD [GLDN]
- HERON [HERN]
- LATTE [LATT]
- MOSS [MOSS]
- RUSSET [RUSS]
- SUNSET [SUNS]

10734-60	Limber Maple	4886-38	Pearl Soapstone	THE FOLLOWING WILSONART STANDARD PATTERN HPL'S ARE AVAILABLE AT STANDARD LIST PRICES WITH EXTENDED LEAD TIMES.	
10745-60	Fonthill Pear	4887-38	Tan Soapstone	1572-38	Antique White
10776-60	Kensington Maple	4888-38	Rustic Slate	1573-38	Frosty White
1500-60	Grey	4904-38	Desert Springs	4550-60	Granite
1503-60	Putty	4905-38	Spicewood Springs	4551-60	Blackstar Granite
1530-60	Beige	4907-38	Deep Springs	4552-60	Ebony Star
1531-60	Light Beige	4909-60	Ginseng Tea	4595-60	Bahia Granite
1570-60	White	4911-38	Soft Gold Mesh	4724-60	Milano Amber
1572-60	Antique White	4912-38	Gilded Mesh	4725-60	Milano Brown
1573-60	Frosty White	4913-60	Eggplant	4726-60	Milano Quartz
1595-60	Black	4915-60	Tangerine	4781-60	Sunstone
1787-60	Oxide	4918-60	Sprout	4835-60	Tumbled Roca
2932-60	Almond Leather	4919-60	Blue Agave	4860-38	Silver Alchemy
4142-60	Grey Glace	4924-38	White Carrara	4861-38	Gold Alchemy
4143-60	Neutral Glace	4929-38	Bordeaux Juparana	7039-38	Windsor Mahogany
4166-60	Pampas	4931-38	White Juparana	7039-60	Windsor Mahogany
4168-60	Grey Pampas	4932-38	Golden Juparana	7040-60	Figured Mahogany
4170-60	Beige Pampas	7054-60	Wild Cherry	7054-38	Wild Cherry
4621-60	White Nebula	7061-60	Natural Pear	7110-60	Montana Walnut
4623-60	Graphite Nebula	7806-60	Bannister Oak	7122-38	Empire Mahogany
4630-60	Cloud Nebula	7816-60	Solar Oak	7122-60	Empire Mahogany
4633-60	Natural Nebula	7850-60	Beigewood	7209-60	Nepal Teak
4651-60	Navy Legacy	7909-60	Fusion Maple	7885-60	English Oak
4656-60	Bronze Legacy	7911-60	Manitoba Maple	7919-38	Amber Cherry
4663-60	Tawny Legacy	7921-38	Tuscan Walnut	7919-60	Amber Cherry
4667-60	Green Tigris	7925-38	Monticello Maple	7921-60	Tuscan Walnut
4669-60	Natural Tigris	7928-38	Castle Oak	7922-38	Brighton Walnut
4674-60	Evening Tigris	7929-38	Huntington Maple	7922-60	Brighton Walnut
4745-60	Maroochy Brush	7937-38	River Cherry	7923-60	Versailles Anigre
4746-60	Woolamai Brush	7938-38	New Age Oak	7924-38	Biltmore Cherry
4762-60	Mystique Dawn	7946-38	Brazilwood	7924-60	Biltmore Cherry
4779-60	Pewter Brush	7953-38	Harvest Maple	7925-60	Monticello Maple
4783-60	White Tigris	7954-38	Natural Rift	7928-60	Castle Oak
4794-60	Windswept Bronze	D14-60	Port	7929-60	Huntington Maple
4795-60	Windswept Pewter	D25-60	Atlantis	7933-60	Cafelle
4796-60	Burnished Chestnut	D30-60	Natural Almond	7935-60	Shaker Cherry
4810-60	Titanium EV	D307-60	Hollyberry	7936-60	Williamsburg Cherry
4811-60	Silicon EV	D315-60	Platinum	7937-60	River Cherry
4813-60	Nickel EV	D321-60	Brittany Blue	7938-60	New Age Oak
4814-60	Tungsten EV	D327-60	Pepperdust	7939-38	Blond Echo
4820-60	Carbon EV	D354-60	Designer White	7941-38	Tan Echo
4823-60	Antique Brush	D379-60	Indigo	7942-38	Cocobala
4835-38	Tumbled Roca	D381-60	Fashion Grey	7943-38	Colombian Walnut
4841-60	Desert Zephyr	D403-60	White Sand	7944-38	Madagascar
4842-60	Canyon Zephyr	D417-60	Lapis Blue	7945-38	Xanadu
4843-60	Misted Zephyr	D431-60	Alabaster	7947-38	Rio
4844-60	Loden Zephyr	D439-60	Wallaby	7948-38	Mambo
4845-60	Twilight Zephyr	D495-60	Coffee Bean	7949-38	Asian Night
4846-60	Morro Zephyr	D50-60	Khaki Brown	7951-38	Asian Sun
4856-60	Cloud Zephyr	D90-60	North Sea	7952-38	Asian Sand
4857-60	Shadow Zephyr	D91-60	Slate Grey	7957-38	Zanzibar
4859-60	Spiced Zephyr	D92-60	Dove Grey	7959-38	Hampton Walnut
4869-60	Western White	D96-60	Shadow	7960-38	Studio Teak
4871-60	Western Suede			7962-38	Aloe
4876-38	Sheer Mesh			D12-60	Regimental Red
4877-38	Grey Mesh			D26-60	Persian Blue
4878-38	Pewter Mesh			D315-38	Platinum
4879-38	Steel Mesh				
4880-38	Carbon Mesh				
4882-38	Oiled Soapstone				
4883-38	Sable Soapstone				
4885-38	Green Soapstone				

LOCKING INFORMATION

Factory Installed Locks are always keyed alike with key number 345T.

SPECIFIC KEY OPTIONS

Requirements for specific key options by office must be specified on the purchase order at the time the order is placed. Model Numbers with specific key options will specify "NO LOCK CORE" on the acknowledgment. A separate line item will be listed on the acknowledgment as "LOCK CORE SET." Specific lock cores and keys will be sent separately (see Field Installation below).

KEYLESS CABINET LOCKING SYSTEM

Keyless cabinet locking system uses radio frequency technology. One transmitter pad can operate single or multiple receiver latches. The locking system operates with separate and programmable user and supervisor codes. Optional modes are available for manual locking, self locking or single use locking of drawers and doors. Please contact your Customer Service Representative for applicability and for a price quotation.

FIELD INSTALLATION

Blank lock cores are installed at factory, allowing specific lock numbers to be ordered but shipped in a separate package for field installation. Lock Core Order Form (see page F) must be filled out and submitted with the purchase order. Lock core/key numbers 100 through 150 are available.

For quantity of locks per unit, please visit www.firstoffice.com and select Resources > Forms & Guides > Lock Core Guide.

RE-KEYING IN THE FIELD

Lock cores and keys can be purchased separately. The purchase order must specify quantity, key number(s) and color of the core (available in nickel, brass or black). Key numbers above number 150 are not stocked and may require a 3-week lead time. Orders ship standard UPS ground. Please note: A lock core change tool must be ordered for lock cores that will be re-keyed in the field.

ITEM

- Lock Core and Key **\$19 list**
- Lock Core Change Tool **\$29 list**
- Master Key **\$29 list**

ALL ITEMS ARE NON-RETURNABLE.

WOOD CARE

Careful craftsmanship combined with our Euroluxe finish makes your new OFS wood furniture incredibly durable, and with proper care your furniture will provide beauty and convenience for years.

All OFS products undergo rigid color-match procedures to ensure the best in color consistency.

- Dust frequently using a soft, damp, clean cloth, wiping with the grain.
- Remove liquid spills immediately, using a blotting rather than wiping motion.
- To clean, use a glass cleaner formulated with ammonia. Apply a small amount to a soft dry cloth and wipe in the direction of the grain. Dry with a soft cloth. Do not use furniture polish containing oil or silicone.
- Avoid prolonged exposure to direct sunlight, high humidity, extreme heat or cold and moisture.

LAMINATE CARE

- Avoid prolonged exposure to direct sunlight, high humidity, extreme heat or cold and moisture.
- Dust frequently with a soft, damp, clean cloth or mild detergent solution. Avoid using chemical or abrasive cleaning compounds.
- To avoid build up of cleaning agents, rinse the laminate surface with warm water and wipe with a clean damp cloth.

SEATING CARE

- Dust exposed wood parts frequently using a soft, damp, clean cloth, wiping with the grain.
- To clean wood, use a glass cleaner formulated with ammonia. Apply a small amount to a soft dry cloth and wipe in the direction of the grain. Dry with a soft cloth. Do not use furniture polish containing oil or silicone.
- To clean leather and vinyl upholstery, use a warm, damp cloth to restore a bright finish. For stubborn stains, use a moisturizing soap. Remove lather with a damp cloth, but do not rinse. Buff with a dry cloth.
- For fabric upholstery, use a damp cloth to wipe up spills. For tougher stains, contact your local OFS dealer for cleaning instructions.
- Avoid prolonged exposure to direct sunlight, high humidity, extreme heat or cold and moisture.
- The components of your OFS chair, such as controls, casters and understructure, require “common sense” care and cleaning as necessary.
- Activate chair mechanisms periodically to ensure proper function of moving parts.

CORIAN SOLID SURFACE CARE

- Washing with soap and water is usually sufficient to remove surface dirt or stains.
- Ammonia based liquid cleaner (not window cleaner) may also be used. Always rinse surface thoroughly and wipe dry.
- Drying is an important step, preventing a build-up of soap film or cleaning residue, which can create the appearance of light scratches over time.
- Stubborn soap film or cleaning residue build-up in Corian® is easily removed with abrasive cleanser and a white Scotch-Brite® pad or a sponge.
- For darker colors, a polish may be used to enhance the shine. For areas where there may be food contact, always use a polish formulated for food contact areas, such as Countertop Magic®. Where food contact is not a possibility, a simple furniture polish may be used. Always follow the manufacturer’s instructions for using the polish and for safety concerns.

PLEASE REFERENCE OUR QUICKSHIP PRICEBOOK FOR A COMPLETE LISTING OF AVAILABLE PRODUCT OFFERED ON OUR QUICKSHIP PROGRAM.





All OFS and Carolina products have achieved **SCS Indoor Advantage Gold Certification** from SCS Global Services. Indoor Advantage Gold certification is SCS Global Services' highest level of indoor air quality performance for furniture. The certification assures that furniture products support a healthy indoor environment by meeting strict chemical emission limits for volatile organic compounds (VOCs). To be certified, products must be tested by independent labs for compliance with the ANSI/BIFMA X7.1, and either ANSI/BIFMA e.3 or CDPH/EHLB Standard Method V1-1 for VOC emissions of concerns.



level® is the multi-attribute, sustainability standard and third-party certification program for the furniture industry. It has been created to deliver the most open and transparent means of evaluating and communicating the environmental and social impacts of furniture products in the built environment. Taking into account a company's social actions, energy usage, material selection and human and ecosystem health impacts, level addresses how a product is sustainable from multiple perspectives. With level, customers can make informed choices about commercial furniture that exceed single attribute ecocertifications. The level brand identifies that a product has been vetted by an independent third party certifier and its numeric marking 1, 2, or 3 indicates what threshold of certification it has achieved. Manufacturers—big and small—now have a methodology to present the environmental characteristics in a clear, easily understood manner with a vernacular that gives end users the ability to make an “apples to apples” comparison.



SCS Global Services [**SCS**] has been providing global leadership in third-party quality, environmental and sustainability verification, certification, auditing, testing, and standards development for three decades. Its programs span a cross-section of industries, recognizing achievements in green building, product manufacturing, food and agriculture, forestry, power generation retail, and more. SCS is accredited to provide services under a wide range of nationally and internationally recognized certification programs. Consistent with its mission, SCS is a chartered benefit corporation and Certified B Corp™, reflecting its commitment to socially and environmentally responsible business practices.



The mark of responsible forestry

The FSC® standards [**Forest Stewardship Council®**] represent the world's strongest system for guiding forest management toward sustainable outcomes. us.fsc.org FSC certified products are manufactured with material that comes from managed forests that are traceable from the time the logs are cut to the time the final project is installed and are recorded by way of a COC or chain of custody claim on all invoices. The demand for certified forest products has grown significantly in recent years. OFS' and Carolina goal to act as a responsible steward of the environment encouraged us to pursue our FSC Chain of Custody [COC] certification which would provide our customers (Dealer, A&D Community and End-users) the added reassurance they've done their part to be earth friendly in their product purchase and enable them to substantiate the LEED [**Leadership in Energy and Environmental Design**] Materials & Resources Credits for certified wood, in which the intent is to encourage environmentally responsible forest management. FSC certification is optional on many, but not all, OFS' and Carolina product lines. Please contact OFS or Carolina Customer Service for information in regards to which of our product lines are available as FSC certified, and what the necessary procedures are for ordering FSC certified products from OFS and Carolina.



OFS' and Carolina company-owned transportation company, Styline Logistics, is **SmartWay**-certified. SmartWay is one of U.S Environmental Protection Agency's [**EPA**] clean air programs that uses voluntary, rather than regulatory methods, to achieve air quality benefits. SmartWay's focus is in the transportation sector, and encompasses products and services associated with fuel-consuming engines.



The "**Premium Indiana Forest Products**" brand tells everyone that there is an abundant, sustainable supply of the finest Indiana hardwoods to meet consumer demand. It also tells them that Indiana's forests are well-managed, legally-harvested and environmentally responsible. The logo is reflective of the wood itself. Indiana hardwoods display a depth that defies imagination.

PRODUCT REFERENCE | EASY MODIFICATION LIST

Moisture Barrier

Moisture Barrier is designed to prevent moisture from penetrating the foam and other filling materials and is available on most items at an additional charge. Moisture barrier is applied between the upholstery cover and filling materials.

Seat
\$56 chair
\$112 loveseat
\$168 sofa

Please use the following option codes when specifying placement of moisture barrier.

- B1V** Moisture barrier on seat only
- B1W** Moisture barrier on back only
- C1R** Moisture barrier on seat and back
- C1S** Moisture barrier on seat and arms
- C1T** Moisture barrier on arms only
- C1U** Moisture barrier on back and arms
- C1V** Moisture barrier on seat, back and arms

Back
\$56 chair
\$112 loveseat
\$168 sofa

Arms
\$56 per arm

mod#	modification detail	list price
1. MOD#1	Standard OFS Hardware Pulls	\$25 Each
2. MOD#2	All Modular Top, End Panel, and Back Panel Cut Downs	\$100
3. MOD#3	Move or Add Grommets (customer to specify location)	\$63 Each
4. MOD#4	Reinforced Drawers - factory installed metal support bars. (Available on lateral files and on 16"D file drawers) <i>Applicable on filing in most casegoods 24"D or under. Contact Customer Service or Specials Costing for applicability on other items.</i>	Per \$30 Drawer
5. MOD#5	Fabric Tackboards (any size reduction or an increase in height up to 6")	\$50
6. MOD#6	Contemporary - BBF to FF	No Upcharge
7. MOD#7	Contemporary - FF to BBF	No Upcharge
8. MOD#8	Wire Access Cutout in Back Panel (4" x 4") - Available on Bridges, Returns, Credenzas, & Corner Units. Cannot be located closer than 3" from any edge. For units with Signature Band, top clearance is 6". (customer to specify location)	No Upcharge
9. MOD#9	Wire Access Cutout in Back Panel (12" x 12") - Available on Bridges, Returns, Credenzas, & Corner Units. Cannot be located closer than 3" from any edge. For units with Signature Band, top clearance is 6". (customer to specify location)	No Upcharge
10. MOD#10	Locking (non-electronic) for wood or laminate doors only. Per individual storage section (no vertical divider).	\$150
11. MOD#11	Seating with 2 Different Fabrics Two Same Grade Fabrics = Next Higher Grade Two Different Grade Fabrics = Higher of the Two Three Different Grade Fabrics = Highest of the Three (NOTE: Contrasting welt only available in a single fabric. Two-toned welt is not available.) (Two-tone diagram required from customer at time of ordering - contact customer service)	
12. MOD#12	Plywood Drawers	\$50 Each
13. MOD#13	Venting Slots (customer to specify location)	\$75
14. MOD#14	All Bullets or P Tables Removal of Modesty Panel	No Upcharge
15. MOD#15	Highback or Wallmount Organizers Removal of Doors	No Upcharge
16. MOD#16	Laser Logo Burn In	ONE TIME SET UP FEE NET \$125 + NET \$20 Each
17. MOD#17	Wire Access Door in Back Panel (18" x 15") Left Hinge - Available on Bridges, Returns, Credenzas, & Corner Units. Top clearance is 3". (customer to specify location)	\$445 Each
18. MOD#18	Set of 4 Casters - Available on some Pedestals	\$55
19. MOD#19	Full Wood Panel Set of Doors on Bookcase 72" Tall and under	\$800
20. MOD#20	Full Wood Panel Set of Doors on Bookcase 30" Tall and under	\$375
21. MOD#21	Casegood Units Cutdown — TFL, HPL and Veneer Width Only (cannot affect drawer size, glass or metal items)	15% Upcharge
22. MOD#22	Increase Worksurface or Top Depth from 48"D - 59.5"D — TFL, HPL and Veneer Only Excludes 3D Laminate Tops (Note: larger tops may require proportionately larger bases and support)	35% Upcharge
23. MOD#23	Specify Built Up TFL Units Only in Two Color Options Must Indicate Specific Laminate Placement (<i>drawing recommended</i>)	No Upcharge
24. MOD#24	Fabric Treatment Applications A number of protective fabric finishes (e.g. Nanotex, Durablock) are available through various fabric vendors. For these special finish treatments the following upcharges will apply. These upcharges will show as a separate line item on order acknowledgements. Any special fabric treatments should be clearly indicated on the purchase order. NOTE: For yardage over 35 yards contact Customer Service for pricing.	One Application up to 35 yds- \$250 per fabric Two Applications up to 35 yds- \$350 per fabric

BASIL LOUNGE STANDARD FEATURES

- Clean-Thru Design
- Upholstered Seat, Back and Sides on 5110-1 and 5110-2
- Upholstered Seat and Sides on 5110-B42
- Tight Cushion
- Armless
- Wall-Saver Design
- Tapered European Beech Legs
- Non-Marring Adjustable Glides

CHAIR

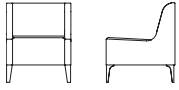

w	outside			sw	seat			seat to top of back	arm height	weight lbs.	cubic feet
	d	h			sd	sh					
26	27.5	32		21	20	18	14	n/a	60	27	

model	yds com (54")	sq ft col	com 1	col 2	3	4	5	6	7	8	9	10	11	12	13	14	15	L1	L2	L3
5110-1	4	n/a	1,499	1,565	1,640	1,734	1,866	2,054	2,242	2,430	2,618	2,806	2,994	3,182	3,371	3,559	3,747	2,307	2,496	2,683

LOVESEAT

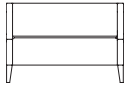

w	outside			sw	seat			seat to top of back	arm height	weight lbs.	cubic feet
	d	h			sd	sh					
47	27.5	32		42	20	18	14	n/a	90	40	

model	yds com (54")	sq ft col	com 1	col 2	3	4	5	6	7	8	9	10	11	12	13	14	15	L1	L2	L3
5110-2	5	n/a	1,914	1,996	2,090	2,208	2,372	2,608	2,843	3,078	3,313	3,548	3,783	4,018	4,253	4,489	4,724	2,917	3,154	3,387

STRAIGHT BENCH



w	outside			sw	seat			seat to top of back	arm height	weight lbs.	cubic feet
	d	h			sd	sh					
42	27.5	18		n/a	n/a	n/a	n/a	n/a	n/a	75	21

model	yds com (54")	sq ft col	com 1	col 2	3	4	5	6	7	8	9	10	11	12	13	14	15	L1	L2	L3
5110-B42	2.25	n/a	1,044	1,081	1,123	1,176	1,250	1,356	1,462	1,568	1,674	1,779	1,885	1,991	2,097	2,203	2,308	1,511	1,617	1,722

BASIL METAL AND WOOD ARM STANDARD FEATURES

- Not available on Basil Bench Seating
- Brushed Aluminum Finish on Metal Arms
- Poly Arm Caps standard on Metal Arm
- European Beech Wood Arm
- Poly Arm Cap optional on Wood Arm

ARM



w	outside			sw	seat			seat to top of back	arm height	weight lbs.	cubic feet
	d	h			sd	sh					
2.25	21.25	8.75		n/a	n/a	n/a	n/a	25.25	10	n/a	

OPTIONS

Metal Arms	Wood Arms and Arm Caps	Leg	Arm/Leg Finish (if applicable)	Seat Back	Fabric 1
Standard X9 No Selection of Option	Standard X9 No Selection of Option	Standard C8 Wood Leg	Selection Required	Standard X9 No Selection of Option	Selection Required
E1Y Brushed Aluminum Arms with Black Poly Arm Cap \$583 pair NOTE: Not available on 5110-B42	F1B Wood Arms (specify finish) \$393 pair A4 Poly Arm Caps (black) for Wood Arm \$210 pair NOTE: Not available on 5110-B42	D1E Brushed Aluminum Metal Leg	See page 9 for full list of finish options	L4 Back Bump Guard (not available on 5110-B42) \$183	Fabric: Grade, Vendor, Pattern, Color NOTE: For multiple fabric applications see page 14 for information and pricing

HOW TO ORDER

SPECIFY: Arms and arm caps | legs | wood finish (if applicable) | seat back | textile pattern and color. See pages 5-14 for information and options on moisture barrier, CAL133, upholstery applications, a complete offering of finishes and ordering details.

MODEL NUMBER					
5110-1					
Metal Arms	Wood Arms and Arm Caps	Leg	Arm/Leg Finish (if applicable)	Seat Back	Fabric 1
X9	F1B - A4	C8	MNW	L4	Grade 5, Momentum, Row, Breeze

ROUND OTTOMAN STANDARD FEATURES

- Fully Upholstered
- Concealed Glide (Standard)

- Construction:
- Fabricated Structures are Upholstered Utilizing High Resilient Polyurethane Foam for Long-Lasting Support and Comfort

- Base:
- Base is Standard with Concealed Glides. Optional Bases are Available.
 - Optional Tablet in Maple Veneer or 3D Laminate



w	outside d	h	sw	seat sd	sh	weight lbs.	cubic feet
20.75	20.75	17.75	20.75	20.75	17.75	21	9

• 18.5"H with HIS, H3Z, C4Y and H3Y Options

model	Top Grade/Fabric yds com (54")	sq ft col	com 1	col 2	3	4	5	6	7	8	9	10	11	12	13	14	15	L1	L2	L3
C49058	0.75	15	202	214	228	246	271	306	341	377	412	447	482	518	553	588	623	376	412	447

model	Side Grade/Fabric yds com (54")	sq ft col	com 1	col 2	3	4	5	6	7	8	9	10	11	12	13	14	15	L1	L2	L3
C49058	1.25	25	336	357	380	409	451	509	568	627	686	745	803	862	921	980	1,038	608	667	725



w	outside d	h	sw	seat sd	sh	weight lbs.	cubic feet
25.5	25.5	17.75	20.75	20.75	17.75	30	13

model	Top Grade/Fabric yds com (54")	sq ft col	com 1	col 2	3	4	5	6	7	8	9	10	11	12	13	14	15	L1	L2	L3
C49158	1	20	275	291	310	334	367	414	461	508	555	602	649	696	743	790	837	498	545	592

model	Side Grade/Fabric yds com (54")	sq ft col	com 1	col 2	3	4	5	6	7	8	9	10	11	12	13	14	15	L1	L2	L3
C49158	1.25	25	343	364	387	416	458	516	575	634	693	752	810	869	928	987	1,045	615	674	732

OPTIONS

Tablet Post Color	Tablet Finish	Weighted	Base	Finish (C4Y only)	Top Fabric/Grade	Side Fabric/Grade
X9 None BKO Black MSL Luster Grey PAL Polished Aluminum WHT White	X9 None Maple Veneer \$539 <i>Quartered</i> QEC PWM PCO MGW MRO MGO MNW MSO <i>Flat Cut</i> MFC BUW MBM MLC MSW MHM MMC MVW 3D Laminate \$539 <i>Quartered</i> EN3 PW3 QE3 NW3 CO3 ST3 <i>Flat Cut</i> LC3 BE3 MH3 MC3 LM3 Solid Color Laminate \$539 <i>Quartered</i> FW3 PN3 WL3 GR3 RW3 BL3	X9 None H4K Weighted \$116	QZ Concealed Glide - Standard HIS Caster \$97 H3Z Caster Softwheel \$97 C4Y Wood Leg (specify finish) \$236 H3Y Active \$163 (available on C49058 only) QZ Concealed Glide - Standard C4Y Wood Leg (specify finish) \$236 H3Y Active \$163 (available on C49058 only) Note: Caster option not available on H4K	Veneer <i>Quartered</i> QEC PWM PCO MGW MRO MGO MNW MSO <i>Flat Cut</i> MFC BUW MBM MLC MSW MHM MMC MVW Paint BLK	Grade, Vendor, Pattern, Color	Grade, Vendor, Pattern, Color

HOW TO ORDER

SPECIFY: Tablet post color | tablet finish | weighted | base | finish (if applicable) | top fabric | side fabric.
See pages 5-14 for the designator finish name and graded-in fabric options.

MODEL NUMBER

C49058

Tablet Post Color	Tablet Finish	Weighted	Base	Finish (C4Y only)	Top Fabric/Grade	Side Fabric/Grade
X9	X9	X9	QZ		Grade 4, Momentum, Hue, Smoke	Grade 4, Momentum, Hue, Smoke

ROUND OTTOMAN STANDARD FEATURES

- Fully Upholstered
- Concealed Glide (Standard)

Construction:

- Fabricated Structures are Upholstered Utilizing High Resilient Polyurethane Foam for Long-Lasting Support and Comfort

Base:

- Base is Standard with Concealed Glides. Optional Wood Legs are Available.

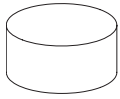

w	outside d	h	sw	seat sd	sh	weight lbs.	cubic feet
36	36	17.75	36	36	17.75	65	19

• 18.5"H with H1S, H3Z, C4Y and H3Y Options

model	Top Grade/Fabric		com 1	col 2	3	4	5	6	7	8	9	10	11	12	13	14	15	L1	L2	L3
	yds com (54")	sq ft col																		
C49258	1.25	25	341	362	385	414	456	514	573	632	691	750	808	867	926	985	1,043	613	672	730

model	Side Grade/Fabric		com 1	col 2	3	4	5	6	7	8	9	10	11	12	13	14	15	L1	L2	L3
	yds com (54")	sq ft col																		
C49258	2.25	45	614	651	693	746	820	926	1,032	1,138	1,244	1,349	1,455	1,561	1,667	1,773	1,878	1,081	1,187	1,292

OPTIONS

Power	Power Faceplate Color	Weighted	Base	Finish (C4Y only)	Top Fabric/Grade	Side Fabric/Grade
<p>X9 None - Standard C5T One Side \$362 C5U Two Sides \$702 C5V Three Sides \$1,052 C5W Four Sides \$1,401</p>  <p>One Power Outlet Two USB Charging Ports</p>	<p>X9 None BLK Black SLV Silver WHT White</p>	<p>X9 None H4K Weighted \$116</p>	<p>QZ Concealed Glide - Standard C4Y Wood Leg (specify finish) \$236</p>	<p>Veneer <i>Quartered</i> QEC PWM PCO MGW MRO MGO MNW MSO <i>Flat Cut</i> MFC BUW MBM MLC MSW MHM MMC MVW</p> <p>Paint BLK</p>	Grade, Vendor, Pattern, Color	Grade, Vendor, Pattern, Color

HOW TO ORDER

SPECIFY: Power | power faceplate color | weighted | base | finish (if applicable) | top fabric | side fabric.
See pages 5-14 for the designator finish name and graded-in fabric options.

MODEL NUMBER

C49258

Power	Power Faceplate Color	Weighted	Base	Finish (C4Y only)	Top Fabric/Grade	Side Fabric/Grade
X9	X9	X9	QZ		Grade 4, Momentum, Hue, Smoke	Grade 4, Momentum, Hue, Smoke

ROUND OTTOMAN WITH REMOVABLE TOP STANDARD FEATURES

- Fully Upholstered
- Removable Top for Storage
- Concealed Glide (Standard)

- Construction:**
- Fabricated Structures are Upholstered Utilizing High Resilient Polyurethane Foam for Long-Lasting Support and Comfort

- Base:**
- Base is Standard with Concealed Glides. Optional Bases are Available.
 - Optional Tablet in Maple Veneer or 3D Laminate



w	outside d	h	sw	seat sd	sh	weight lbs.	cubic feet
20.25	20.25	17.75	20.25	20.25	17.75	34	9

• 18.5"H with HIS, H3Z, C4Y and H3Y Options

model	Top Grade/Fabric yds com (54")	sq ft col	com 1	col 2	3	4	5	6	7	8	9	10	11	12	13	14	15	L1	L2	L3
C49058-R	1	20	380	396	415	439	472	519	566	613	660	707	754	801	848	895	942	603	650	697

model	Side Grade/Fabric yds com (54")	sq ft col	com 1	col 2	3	4	5	6	7	8	9	10	11	12	13	14	15	L1	L2	L3
C49058-R	1	20	380	396	415	439	472	519	566	613	660	707	754	801	848	895	942	603	650	697



w	outside d	h	sw	seat sd	sh	weight lbs.	cubic feet
25	25	17.75	25	25	17.75	43	13

model	Top Grade/Fabric yds com (54")	sq ft col	com 1	col 2	3	4	5	6	7	8	9	10	11	12	13	14	15	L1	L2	L3
C49158-R	1.25	25	485	506	529	558	600	658	717	776	835	894	952	1,011	1,070	1,129	1,187	757	816	874

model	Side Grade/Fabric yds com (54")	sq ft col	com 1	col 2	3	4	5	6	7	8	9	10	11	12	13	14	15	L1	L2	L3
C49158-R	1.25	25	485	506	529	558	600	658	717	776	835	894	952	1,011	1,070	1,129	1,187	757	816	874

OPTIONS

Tablet Post Color	Tablet Finish	Base	Finish (C4Y only)	Top Fabric/Grade	Side Fabric/Grade
X9 None BKO Black MSL Luster Grey PAL Polished Aluminum WHT White	X9 None Maple Veneer \$539 <i>Quartered</i> QEC PWM PCO MGW MRO MGO MNW MSO <i>Flat Cut</i> MFC BUW MBM MLC MSW MHM MMC MVW 3D Laminate \$539 <i>Quartered</i> EN3 PW3 QE3 NW3 CO3 ST3 <i>Flat Cut</i> LC3 BE3 MH3 MC3 LM3 Solid Color Laminate \$539 <i>Quartered</i> FW3 PN3 WL3 GR3 RW3 BL3	QZ Concealed Glide - Standard HIS Caster \$97 H3Z Caster Softwheel \$97 C4Y Wood Leg (specify finish) \$236 H3Y Active \$163 (available on C49058-R only)	Veneer <i>Quartered</i> QEC PWM PCO MGW MRO MGO MNW MSO <i>Flat Cut</i> MFC BUW MBM MLC MSW MHM MMC MVW Paint BLK	Grade, Vendor, Pattern, Color	Grade, Vendor, Pattern, Color

HOW TO ORDER

SPECIFY: Tablet post color | tablet finish | base | finish (if applicable) | top fabric | side fabric.
See pages 5-14 for the designator finish name and graded-in fabric options.

MODEL NUMBER

C49058-R

Tablet Post Color	Tablet Finish	Base	Finish (C4Y only)	Top Fabric/Grade	Side Fabric/Grade
X9	X9	QZ		Grade 4, Momentum, Hue, Smoke	Grade 4, Momentum, Hue, Smoke

ROUND OTTOMAN WITH BACKREST STANDARD FEATURES

- Fully Upholstered
- Short backrest
- Concealed Glide (Standard)

- Construction:**
- Fabricated Structures are Upholstered Utilizing High Resilient Polyurethane Foam for Long-Lasting Support and Comfort

- Base:**
- Base is Standard with Concealed Glides. Optional Bases are Available.
 - Optional Tablet in Maple Veneer or 3D Laminate



w	outside d	h	sw	seat sd	sh	inside Back	arm Height	from floor	weight lbs.	cubic feet
20.25	20.25	22.25	20.25	20.25	17.75	4.75	4.75	22.25	34	9

• 18.5"H to seat and 23"H to backrest with HIS, H3Z, C4Y and H3Y Options

model	Top Grade/Fabric yds com (54")	sq ft col	com 1	col 2	3	4	5	6	7	8	9	10	11	12	13	14	15	L1	L2	L3
C49358	0.75	15	271	283	297	315	340	375	410	446	481	516	551	587	622	657	692	445	481	516

model	Side Grade/Fabric yds com (54")	sq ft col	com 1	col 2	3	4	5	6	7	8	9	10	11	12	13	14	15	L1	L2	L3
C49358	1.5	30	543	568	596	631	681	751	822	892	963	1,033	1,104	1,174	1,245	1,315	1,386	863	935	1,004



w	outside d	h	sw	seat sd	sh	inside Back	arm Height	from floor	weight lbs.	cubic feet
20.25	20.25	22.25	20.25	20.25	17.75	4.75	4.75	22.25	34	9

• 18.5"H to seat and 23"H to backrest with HIS, H3Z, C4Y and H3Y Options

model	Top Grade/Fabric yds com (54")	sq ft col	com 1	col 2	3	4	5	6	7	8	9	10	11	12	13	14	15	L1	L2	L3
C49458	0.75	15	274	286	300	318	343	378	413	449	484	519	554	590	625	660	695	448	484	519

model	Side Grade/Fabric yds com (54")	sq ft col	com 1	col 2	3	4	5	6	7	8	9	10	11	12	13	14	15	L1	L2	L3
C49458	1.75	35	641	670	703	744	801	884	966	1,048	1,131	1,213	1,295	1,378	1,460	1,542	1,624	1,010	1,093	1,175

OPTIONS

Tablet Post Color	Tablet Finish	Location	Weighted	Base	Finish (C4Y only)	Top Fabric/Grade	Side/Back Fabric/Grade
X9 None BKO Black MSL Luster Grey PAL Polished Aluminum WHT White	X9 None  Maple Veneer \$539 <i>Quartered</i> QEC PWM PCO MGW MRO MGO MNW MSO <i>Flat Cut</i> MFC BUW MBM MLC MSW MHM MMC MVW 3D Laminate \$539 <i>Quartered</i> EN3 PW3 QE3 NW3 CO3 ST3 <i>Flat Cut</i> LC3 BE3 MH3 MC3 LM3 Solid Color Laminate \$539 <i>Quartered</i> FW3 PN3 WL3 GR3 RW3 BL3	X9 None UR Left Facing UQ Right Facing	X9 None H4K Weighted \$116	QZ Concealed Glide - Standard HIS Caster \$97 H3Z Caster Softwheel \$97 C4Y Wood Leg (specify finish) \$236 H3Y Active \$163 (available on C49358 only) QZ Concealed Glide - Standard C4Y Wood Leg (specify finish) \$236 H3Y Active \$163 (available on C49358 only) Note: Caster option not available on H4K	Veneer <i>Quartered</i> QEC PWM PCO MGW MRO MGO <i>Flat Cut</i> MFC BUW MBM MLC MSW MHM MMC MVW Paint BLK	Grade, Vendor, Pattern, Color	Grade, Vendor, Pattern, Color

HOW TO ORDER

SPECIFY: Tablet post color | tablet finish | location | weighted | base | finish (if applicable) | top fabric | side fabric.
See pages 5-14 for the designator finish name and graded-in fabric options.

MODEL NUMBER							
C49358							
Tablet Post Color	Tablet Finish	Location	Weighted	Base	Finish (C4Y only)	Top Fabric/Grade	Side/Back Fabric/Grade
X9	X9	X9	X9	QZ		Grade 4, Momentum, Hue, Smoke	Grade 4, Momentum, Hue, Smoke

ROUND OTTOMAN BARSTOOL STANDARD FEATURES

- Fully Upholstered
- Concealed Glide (Standard)

Construction:

- Fabricated Structures are Upholstered Utilizing High Resilient Polyurethane Foam for Long-Lasting Support and Comfort

Base:

- Base is Standard with Concealed Glides.



w	outside d	h	sw	seat sd	sh	weight lbs.	cubic feet
20.75	20.75	29.75	20.75	20.75	29.75	30	14

model	Top Grade/Fabric		com 1	col 2	3	4	5	6	7	8	9	10	11	12	13	14	15	L1	L2	L3
	yds com (54")	sq ft col																		
C49558	0.75	15	169	181	195	213	238	273	308	344	379	414	449	485	520	555	590	343	379	414

model	Side Grade/Fabric		com 1	col 2	3	4	5	6	7	8	9	10	11	12	13	14	15	L1	L2	L3
	yds com (54")	sq ft col																		
C49558	2	40	451	484	522	569	634	728	822	917	1,011	1,105	1,199	1,293	1,387	1,481	1,575	869	964	1,057

OPTIONS

Top Fabric/Grade	Side Fabric/Grade
Grade, Vendor, Pattern, Color	Grade, Vendor, Pattern, Color

HOW TO ORDER

SPECIFY: Top fabric | side fabric.

See pages 5-14 for the designator finish name and graded-in fabric options.

MODEL NUMBER

C49558

Top Fabric/Grade	Side Fabric/Grade
Grade 4, Momentum, Hue, Smoke	Grade 4, Momentum, Hue, Smoke

SQUARE OTTOMAN STANDARD FEATURES

- Fully Upholstered
- Concealed Glide (Standard)

- Construction:**
- Fabricated Structures are Upholstered Utilizing High Resilient Polyurethane Foam for Long-Lasting Support and Comfort

- Base:**
- Base is Standard with Concealed Glides. Optional Bases are Available.
 - Optional Tablet in Maple Veneer or 3D Laminate



w	outside d	h	sw	seat sd	sh	weight lbs.	cubic feet
20.75	20.75	17.75	20.75	20.75	17.75	34	9

• 18.5"H with H1S, H3Z, C4Y and H3Y Options

model	Top Grade/Fabric yds com (54")	sq ft col	com 1	col 2	3	4	5	6	7	8	9	10	11	12	13	14	15	L1	L2	L3
C49059	0.75	15	183	195	209	227	252	287	322	358	393	428	463	499	534	569	604	357	393	428

model	Side Grade/Fabric yds com (54")	sq ft col	com 1	col 2	3	4	5	6	7	8	9	10	11	12	13	14	15	L1	L2	L3
C49059	1.25	25	306	327	350	379	421	479	538	597	656	715	773	832	891	950	1,008	578	537	695

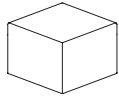

w	outside d	h	sw	seat sd	sh	weight lbs.	cubic feet
25.5	25.5	17.75	25.5	25.5	17.75	33	13

• 18.5"H H1S, H3Z, C4Y and H3Y Options

model	Top Grade/Fabric yds com (54")	sq ft col	com 1	col 2	3	4	5	6	7	8	9	10	11	12	13	14	15	L1	L2	L3
C49159	1	20	246	262	281	305	338	385	432	479	526	573	620	667	714	761	808	469	516	563

model	Side Grade/Fabric yds com (54")	sq ft col	com 1	col 2	3	4	5	6	7	8	9	10	11	12	13	14	15	L1	L2	L3
C49159	1.5	25	369	394	422	457	507	577	648	718	789	859	930	1,000	1,071	1,141	1,212	689	761	830

OPTIONS

Tablet Post Color	Tablet Finish	Weighted	Base	Finish (C4Y only)	Top Fabric/Grade	Side Fabric/Grade
X9 None BKO Black MSL Luster Grey PAL Polished Aluminum WHT White	X9 None Maple Veneer \$539 <i>Quartered</i> QEC PWM PCO MGW MRO MGO MNW MSO <i>Flat Cut</i> MFC BUW MBM MLC MSW MHM MMC MVW 3D Laminate \$539 <i>Quartered</i> EN3 PW3 QE3 NW3 CO3 ST3 <i>Flat Cut</i> LC3 BE3 MH3 MC3 LM3 Solid Color Laminate \$539 <i>Quartered</i> FW3 PN3 WL3 GR3 RW3 BL3	X9 None H4K Weighted \$116	QZ Concealed Glide - Standard H1S Caster \$66 H3Z Caster Softwheel \$66 C4Y Wood Leg (specify finish) \$195 QZ Concealed Glide - Standard C4Y Wood Leg (specify finish) \$195 Note: Caster option not available on H4K	Veneer <i>Quartered</i> QEC PWM PCO MGW MRO MGO MNW MSO <i>Flat Cut</i> MFC BUW MBM MLC MSW MHM MMC MVW Paint BLK	Grade, Vendor, Pattern, Color	Grade, Vendor, Pattern, Color

HOW TO ORDER

SPECIFY: Tablet post color | tablet finish | weighted | base | finish (if applicable) | top fabric | side fabric.
See pages 5-14 for the designator finish name and graded-in fabric options.

MODEL NUMBER						
C49059						
Tablet Post Color	Tablet Finish	Weighted	Base	Finish (C4Y only)	Top Fabric/Grade	Side Fabric/Grade
X9	X9	X9	QZ		Grade 4, Momentum, Hue, Smoke	Grade 4, Momentum, Hue, Smoke

SQUARE OTTOMAN STANDARD FEATURES

- Fully Upholstered
- Concealed Glide (Standard)

Construction:

- Fabricated Structures are Upholstered Utilizing High Resilient Polyurethane Foam for Long-Lasting Support and Comfort

Base:

- Base is Standard with Concealed Glides. Optional Wood Legs are Available.

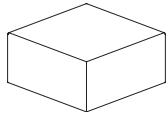

w	outside d	h	sw	seat sd	sh	weight lbs.	cubic feet
36	36	17.75	36	36	17.75	67	19

model	Top Grade/Fabric yds com (54")	sq ft col	com 1	col 2	3	4	5	6	7	8	9	10	11	12	13	14	15	L1	L2	L3
C49259	1.25	25	404	425	448	477	519	577	636	695	754	813	871	930	989	1,048	1,106	676	735	793

model	Side Grade/Fabric yds com (54")	sq ft col	com 1	col 2	3	4	5	6	7	8	9	10	11	12	13	14	15	L1	L2	L3
C49259	2.25	45	727	764	806	859	933	1,039	1,145	1,251	1,357	1,462	1,568	1,674	1,780	1,886	1,991	1,194	1,300	1,405

OPTIONS

Power	Power Faceplate Color	Weighted	Base	Finish (C4Y only)	Top Fabric/Grade	Side Fabric/Grade
<p>X9 None - Standard</p> <p>C5T One Side \$362</p> <p>C5U Two Sides \$702</p> <p>C5V Three Sides \$1,052</p> <p>C5W Four Sides \$1,401</p>	<p>X9 None</p> <p>BLK Black</p> <p>SLV Silver</p> <p>WHT White</p>	<p>X9 None</p> <p>H4K Weighted \$116</p>	<p>QZ Concealed Glide - Standard</p> <p>C4Y Wood Leg (specify finish) \$195</p>	<p>Veneer</p> <p><i>Quartered</i></p> <p>QEC PWM PCO</p> <p>MGW MRO MGO</p> <p>MNW MSO</p> <p><i>Flat Cut</i></p> <p>MFC BUW MBM</p> <p>MLC MSW MHM</p> <p>MMC MVW</p> <p>Paint</p> <p>BLK</p>	Grade, Vendor, Pattern, Color	Grade, Vendor, Pattern, Color



One Power Outlet
Two USB Charging Ports

HOW TO ORDER

SPECIFY: Power | power faceplate color | weighted | base | finish (if applicable) | top fabric | side fabric.
See pages 5-14 for the designator finish name and graded-in fabric options.

MODEL NUMBER

C49259

Power	Power Faceplate Color	Weighted	Base	Finish (C4Y only)	Top Fabric/Grade	Side Fabric/Grade
X9	X9	X9	QZ		Grade 4, Momentum, Hue, Smoke	Grade 4, Momentum, Hue, Smoke

SQUARE OTTOMAN WITH REMOVABLE TOP STANDARD FEATURES

- Fully Upholstered
- Removable Top for Storage
- Concealed Glide (Standard)

- Construction:**
- Fabricated Structures are Upholstered Utilizing High Resilient Polyurethane Foam for Long-Lasting Support and Comfort

- Base:**
- Base is Standard with Concealed Glides. Optional Casters or Wood Legs are Available.



w	outside d	h	sw	seat sd	sh	weight lbs.	cubic feet
20.75	20.75	17.75	20.75	20.75	17.75	39	9

• 18.5"H with HIS, H3Z, C4Y and H3Y Options

model	Top Grade/Fabric yds com (54")	sq ft col	com 1	col 2	3	4	5	6	7	8	9	10	11	12	13	14	15	L1	L2	L3
C49059-R	0.75	15	261	273	287	305	330	365	400	436	471	506	541	577	612	647	682	435	471	506

model	Side Grade/Fabric yds com (54")	sq ft col	com 1	col 2	3	4	5	6	7	8	9	10	11	12	13	14	15	L1	L2	L3
C49059-R	1.25	25	435	456	479	508	550	608	667	726	785	844	902	961	1,020	1,079	1,137	707	766	824

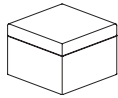

w	outside d	h	sw	seat sd	sh	weight lbs.	cubic feet
25	25	17.75	25	25	17.75	56	13

• 18.5"H HIS, H3Z, C4Y and H3Y Options

model	Top Grade/Fabric yds com (54")	sq ft col	com 1	col 2	3	4	5	6	7	8	9	10	11	12	13	14	15	L1	L2	L3
C49159-R	1	20	364	380	399	423	456	503	550	597	644	691	738	785	832	879	926	587	634	681

model	Side Grade/Fabric yds com (54")	sq ft col	com 1	col 2	3	4	5	6	7	8	9	10	11	12	13	14	15	L1	L2	L3
C49159-R	1.5	30	546	571	599	634	684	754	825	895	966	1,036	1,107	1,177	1,248	1,318	1,389	866	938	1,007

OPTIONS

Tablet Post Color	Tablet Finish	Base	Finish (C4Y only)	Top Fabric/Grade	Side Fabric/Grade
X9 None BKO Black MSL Luster Grey PAL Polished Aluminum WHT White	X9 None Maple Veneer \$539 Quartered QEC PWM PCO MGW MRO MGO MNW MSO Flat Cut MFC BUW MBM MLC MSW MHM MMC MVW 3D Laminate \$539 Quartered EN3 PW3 QE3 NW3 CO3 ST3 Flat Cut LC3 BE3 MH3 MC3 LM3 Solid Color Laminate \$539 Quartered FW3 PN3 WL3 GR3 RW3 BL3	QZ Concealed Glide - Standard HIS Caster \$66 H3Z Caster Softwheel \$66 C4Y Wood Leg (specify finish) \$195	Veneer Quartered QEC PWM PCO MGW MRO MGO MNW MSO Flat Cut MFC BUW MBM MLC MSW MHM MMC MVW Paint BLK	Grade, Vendor, Pattern, Color	Grade, Vendor, Pattern, Color

HOW TO ORDER

SPECIFY: Tablet post color | tablet finish | base | finish (if applicable) | top fabric | side fabric.
See pages 5-14 for the designator finish name and graded-in fabric options.

MODEL NUMBER

C49059-R

Tablet Post Color	Tablet Finish	Base	Finish (C4Y only)	Top Fabric/Grade	Side Fabric/Grade
X9	X9	QZ		Grade 4, Momentum, Hue, Smoke	Grade 4, Momentum, Hue, Smoke

HEX OTTOMAN STANDARD FEATURES

- Fully Upholstered
- Concealed Glide (Standard)

- Construction:**
- Fabricated Structures are Upholstered Utilizing High Resilient Polyurethane Foam for Long-Lasting Support and Comfort

- Base:**
- Base is Standard with Concealed Glides. Optional Bases are Available.
 - Optional Tablet in Maple Veneer or 3D Laminate



w	outside d	h	sw	seat sd	sh	weight lbs.	cubic feet
24	21	17.75	24	21	17.75	23	9

• 18.5"H with H1S, H3Z, C4Y and H3Y Options

model	Top Grade/Fabric yds com (54")	sq ft col	com 1	col 2	3	4	5	6	7	8	9	10	11	12	13	14	15	L1	L2	L3
C49056	0.75	15	181	193	207	225	250	285	320	356	391	426	461	497	532	567	602	355	391	426

model	Side Grade/Fabric yds com (54")	sq ft col	com 1	col 2	3	4	5	6	7	8	9	10	11	12	13	14	15	L1	L2	L3
C49056	1.25	25	302	323	346	375	417	475	534	593	652	711	769	828	887	946	1,004	574	533	691

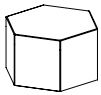

w	outside d	h	sw	seat sd	sh	weight lbs.	cubic feet
29.25	25.75	17.75	29.25	25.75	17.75	30	13

• 18.5"H H1S, H3Z, C4Y and H3Y Options

model	Top Grade/Fabric yds com (54")	sq ft col	com 1	col 2	3	4	5	6	7	8	9	10	11	12	13	14	15	L1	L2	L3
C49156	1	20	230	246	265	289	322	369	416	463	510	557	604	651	698	745	792	453	500	547

model	Side Grade/Fabric yds com (54")	sq ft col	com 1	col 2	3	4	5	6	7	8	9	10	11	12	13	14	15	L1	L2	L3
C49156	1.5	30	344	369	397	432	482	552	623	693	764	834	905	975	1,046	1,116	1,187	664	736	805

OPTIONS

Tablet Post Color	Tablet Finish	Weighted	Base	Finish (C4Y only)	Top Fabric/Grade	Side Fabric/Grade
X9 None BKO Black MSL Luster Grey PAL Polished Aluminum WHT White	X9 None  Maple Veneer \$539 <i>Quartered</i> QEC PWM PCO MGW MRO MGO MNW MSO <i>Flat Cut</i> MFC BUW MBM MLC MSW MHM MMC MVW 3D Laminate \$539 <i>Quartered</i> EN3 PW3 QE3 NW3 CO3 ST3 <i>Flat Cut</i> LC3 BE3 MH3 MC3 LM3 Solid Color Laminate \$539 <i>Quartered</i> FW3 PN3 WL3 GR3 RW3 BL3	X9 None H4K Weighted \$116	QZ Concealed Glide - Standard H1S Caster \$97 H3Z Caster Softwheel \$97 C4Y Wood Leg (specify finish) \$236 QZ Concealed Glide - Standard C4Y Wood Leg (specify finish) \$236 Note: Caster option not available on H4K	Veneer <i>Quartered</i> QEC PWM PCO MGW MRO MGO MNW MSO <i>Flat Cut</i> MFC BUW MBM MLC MSW MHM MMC MVW Paint BLK	Grade, Vendor, Pattern, Color	Grade, Vendor, Pattern, Color

HOW TO ORDER

SPECIFY: Tablet post color | tablet finish | weighted | base | finish (if applicable) | top fabric | side fabric.
See pages 5-14 for the designator finish name and graded-in fabric options.

MODEL NUMBER

C49056

Tablet Post Color	Tablet Finish	Weighted	Base	Finish (C4Y only)	Top Fabric/Grade	Side Fabric/Grade
X9	X9	X9	QZ		Grade 4, Momentum, Hue, Smoke	Grade 4, Momentum, Hue, Smoke

HEX OTTOMAN STANDARD FEATURES

- Fully Upholstered
- Concealed Glide (Standard)

Construction:

- Fabricated Structures are Upholstered Utilizing High Resilient Polyurethane Foam for Long-Lasting Support and Comfort

Base:

- Base is Standard with Concealed Glides. Optional Wood Legs are Available.

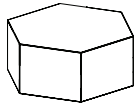

w	outside d	h	sw	seat sd	sh	weight lbs.	cubic feet
41.75	36	17.75	41.75	36	17.75	67	23

model	Top Grade/Fabric yds com (54")	sq ft col	com 1	col 2	3	4	5	6	7	8	9	10	11	12	13	14	15	L1	L2	L3
C49256	1.25	25	348	369	392	421	463	521	580	639	698	757	815	874	933	992	1,050	620	679	737

model	Side Grade/Fabric yds com (54")	sq ft col	com 1	col 2	3	4	5	6	7	8	9	10	11	12	13	14	15	L1	L2	L3
C49256	2	40	557	590	628	675	740	834	928	1,023	1,117	1,211	1,305	1,399	1,493	1,587	1,681	975	1,070	1,163

OPTIONS

Power	Power Faceplate Color	Weighted	Base	Finish (C4Y only)	Top Fabric/Grade	Side Fabric/Grade
X9 None - Standard C5T One Side \$362 C5U Two Sides \$702 C5V Three Sides \$1,052  One Power Outlet Two USB Charging Ports	X9 None BLK Black SLV Silver WHT White	X9 None H4K Weighted \$116	QZ Concealed Glide - Standard C4Y Wood Leg (specify finish) \$236	Veneer <i>Quartered</i> QEC PWM PCO MGW MRO MGO MNW MSO <i>Flat Cut</i> MFC BUW MBM MLC MSW MHM MMC MVW Paint BLK	Grade, Vendor, Pattern, Color	Grade, Vendor, Pattern, Color

HOW TO ORDER

SPECIFY: Power | power faceplate color | weighted | base | finish (if applicable) | top fabric | side fabric.
See pages 5-14 for the designator finish name and graded-in fabric options.

MODEL NUMBER

C49256

Power	Power Faceplate Color	Weighted	Base	Finish (C4Y only)	Top Fabric/Grade	Side Fabric/Grade
X9	X9	X9	QZ		Grade 4, Momentum, Hue, Smoke	Grade 4, Momentum, Hue, Smoke

HEX OTTOMAN WITH REMOVABLE TOP STANDARD FEATURES

- Fully Upholstered
- Removable Top for Storage
- Concealed Glide (Standard)

- Construction:**
- Fabricated Structures are Upholstered Utilizing High Resilient Polyurethane Foam for Long-Lasting Support and Comfort

- Base:**
- Base is Standard with Concealed Glides. Optional Bases are Available.
 - Optional Tablet in Maple Veneer or 3D Laminate



w	outside d	h	sw	seat sd	sh	weight lbs.	cubic feet
23.25	20	17.75	23.5	20.5	17.75	31	9

• 18.5"H with H1S, H3Z, C4Y and H3Y Options

model	Top Grade/Fabric yds com (54")	sq ft col	com 1	col 2	3	4	5	6	7	8	9	10	11	12	13	14	15	L1	L2	L3
C49056-R	0.75	15	306	318	332	350	375	410	445	481	516	551	586	622	657	692	727	480	516	551

model	Side Grade/Fabric yds com (54")	sq ft col	com 1	col 2	3	4	5	6	7	8	9	10	11	12	13	14	15	L1	L2	L3
C49056-R	1	20	409	425	444	468	501	548	595	642	689	736	783	830	877	924	971	632	679	726

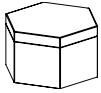

w	outside d	h	sw	seat sd	sh	weight lbs.	cubic feet
29.25	25.5	17.75	29.25	25.5	17.75	46	13

• 18.5"H H1S, H3Z, C4Y and H3Y Options

model	Top Grade/Fabric yds com (54")	sq ft col	com 1	col 2	3	4	5	6	7	8	9	10	11	12	13	14	15	L1	L2	L3
C49156-R	1	20	431	447	466	490	523	570	617	664	711	758	805	852	899	946	993	654	701	748

model	Side Grade/Fabric yds com (54")	sq ft col	com 1	col 2	3	4	5	6	7	8	9	10	11	12	13	14	15	L1	L2	L3
C49156-R	1	20	431	447	466	490	523	570	617	664	711	758	805	852	899	946	993	654	701	748

OPTIONS

Tablet Post Color	Tablet Finish	Base	Finish (C4Y only)	Top Fabric/Grade	Side Fabric/Grade
X9 None BKO Black MSL Luster Grey PAL Polished Aluminum WHT White	X9 None  Maple Veneer \$539 Quartered QEC PWM PCO MGW MRO MGO MNW MSO Flat Cut MFC BUW MBM MLC MSW MHM MMC MVW 3D Laminate \$539 Quartered EN3 PW3 QE3 NW3 CO3 ST3 Flat Cut LC3 BE3 MH3 MC3 LM3 Solid Color Laminate \$539 Quartered FW3 PN3 WL3 GR3 RW3 BL3	QZ Concealed Glide - Standard H1S Caster \$97 H3Z Caster Softwheel \$97 C4Y Wood Leg (specify finish) \$236	Veneer Quartered QEC PWM PCO MGW MRO MGO MNW MSO Flat Cut MFC BUW MBM MLC MSW MHM MMC MVW Paint BLK	Grade, Vendor, Pattern, Color	Grade, Vendor, Pattern, Color

HOW TO ORDER

SPECIFY: Tablet post color | tablet finish | base | finish (if applicable) | top fabric | side fabric.
See pages 5-14 for the designator finish name and graded-in fabric options.

MODEL NUMBER

C49056-R

Tablet Post Color	Tablet Finish	Base	Finish (C4Y only)	Top Fabric/Grade	Side Fabric/Grade
X9	X9	QZ		Grade 4, Momentum, Hue, Smoke	Grade 4, Momentum, Hue, Smoke

HEX OTTOMAN WITH BACKREST STANDARD FEATURES

- Fully Upholstered
- Short backrest
- Concealed Glide (Standard)

- Construction:**
- Fabricated Structures are Upholstered Utilizing High Resilient Polyurethane Foam for Long-Lasting Support and Comfort

- Base:**
- Base is Standard with Concealed Glides. Optional Bases are Available.
 - Optional Tablet in Maple Veneer or 3D Laminate

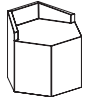

w	outside d	h	sw	seat sd	sh	inside back	weight lbs.	cubic feet
23.5	20.5	22.25	20	18.75	17.75	4.75	30	11

• 18.5"H to seat and 23"H to backrest with with H1S, H3Z, C4Y and H3Y Options

model	Top Grade/Fabric yds com (54")	sq ft col	com 1	col 2	3	4	5	6	7	8	9	10	11	12	13	14	15	L1	L2	L3
C49356	0.75	15	253	265	279	297	322	357	392	428	463	498	533	569	604	639	674	427	463	498

model	Side Grade/Fabric yds com (54")	sq ft col	com 1	col 2	3	4	5	6	7	8	9	10	11	12	13	14	15	L1	L2	L3
C49356	1.25	25	422	443	466	495	537	595	654	713	772	831	889	948	1,007	1,066	1,124	694	753	811

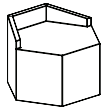

w	outside d	h	sw	seat sd	sh	inside back	weight lbs.	cubic feet
28.75	25	22.25	25.5	23.75	17.75	4.75	40	16

• 18.5"H to seat and 23"H to backrest with with H1S, H3Z, C4Y and H3Y Options

model	Top Grade/Fabric yds com (54")	sq ft col	com 1	col 2	3	4	5	6	7	8	9	10	11	12	13	14	15	L1	L2	L3
C49456	1	20	307	323	342	366	399	446	493	540	587	634	681	728	775	822	869	530	577	624

model	Side Grade/Fabric yds com (54")	sq ft col	com 1	col 2	3	4	5	6	7	8	9	10	11	12	13	14	15	L1	L2	L3
C49456	1.5	30	460	485	513	548	598	668	739	809	880	950	1,021	1,091	1,162	1,232	1,303	780	852	921

OPTIONS

Tablet Post Color	Tablet Finish	Location	Weighted	Base	Finish (C4Y only)	Top Fabric/Grade	Side/Back Fabric/Grade
X9 None BKO Black MSL Luster Grey PAL Polished Aluminum WHT White	X9 None  Maple Veneer \$539 Quartered QEC PWM PCO MGW MRO MGO MNW MSO Flat Cut MFC BUW MBM MLC MSW MHM MMC MVW 3D Laminate \$539 Quartered EN3 PW3 QE3 NW3 CO3 ST3 Flat Cut LC3 BE3 MH3 MC3 LM3 Solid Color Laminate \$539 Quartered FW3 PN3 WL3 GR3 RW3 BL3	X9 None UR Left Facing UQ Right Facing	X9 None H4K Weighted \$116	QZ Concealed Glide - Standard H1S Caster \$97 H3Z Caster Softwheel \$97 C4Y Wood Leg (specify finish) \$236 QZ Concealed Glide - Standard C4Y Wood Leg (specify finish) \$236 Note: Caster option not available on H4K	Veneer Quartered QEC PWM PCO MGW MRO MGO MNW MSO Flat Cut MFC BUW MBM MLC MSW MHM MMC MVW Paint BLK	Grade, Vendor, Pattern, Color	Grade, Vendor, Pattern, Color

HOW TO ORDER

SPECIFY: Tablet post color | tablet finish | location | weighted | base | finish (if applicable) | top fabric | side fabric.
See pages 5-14 for the designator finish name and graded-in fabric options.

MODEL NUMBER

C49356

Tablet Post Color	Tablet Finish	Location	Weighted	Base	Finish (C4Y only)	Top Fabric/Grade	Side/Back Fabric/Grade
X9	X9	X9	X9	QZ		Grade 4, Momentum, Hue, Smoke	Grade 4, Momentum, Hue, Smoke

TRAP OTTOMAN STANDARD FEATURES

- Fully Upholstered
- Concealed Glide (Standard)

Construction:

- Fabricated Structures are Upholstered Utilizing High Resilient Polyurethane Foam for Long-Lasting Support and Comfort

Base:

- Base is Standard with Concealed Glides. Optional Bases are Available.
- Optional Tablet in Maple Veneer or 3D Laminate



w	outside d	h	sw	seat sd	sh	weight lbs.	cubic feet
20.75	20.5	17.75	20.75	20.5	17.75	21	9

• 18.5"H with H1S, H3Z, C4Y and H3Y Options

model	Top Grade/Fabric yds com (54")	sq ft col	com 1	col 2	3	4	5	6	7	8	9	10	11	12	13	14	15	L1	L2	L3
C49057	0.75	15	172	184	198	216	241	276	311	347	382	417	452	488	523	558	593	346	382	417

model	Side Grade/Fabric yds com (54")	sq ft col	com 1	col 2	3	4	5	6	7	8	9	10	11	12	13	14	15	L1	L2	L3
C49356	1.25	25	286	307	330	359	401	459	518	577	636	695	753	812	871	930	988	558	614	675

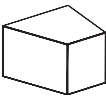

w	outside d	h	sw	seat sd	sh	weight lbs.	cubic feet
25.5	25.25	17.75	25.5	25.25	17.75	13	16

• 18.5"H with H1S, H3Z, C4Y and H3Y Options

model	Top Grade/Fabric yds com (54")	sq ft col	com 1	col 2	3	4	5	6	7	8	9	10	11	12	13	14	15	L1	L2	L3
C49157	0.75	15	183	195	209	227	252	287	322	358	393	428	463	499	534	569	604	357	393	428

model	Side Grade/Fabric yds com (54")	sq ft col	com 1	col 2	3	4	5	6	7	8	9	10	11	12	13	14	15	L1	L2	L3
C49157	1.5	30	368	393	421	456	506	576	647	717	788	858	929	999	1,070	1,140	1,211	688	760	829

OPTIONS

Tablet Post Color	Tablet Finish	Location	Weighted	Base	Finish (C4Y only)	Top Fabric/Grade	Side Fabric/Grade
X9 None BKO Black MSL Luster Grey PAL Polished Aluminum WHT White	X9 None Maple Veneer \$539 Quartered QEC PWM PCO MGW MRO MGO MNW MSO Flat Cut MFC BUW MBM MLC MSW MHM MMC MVW 3D Laminate \$539 Quartered EN3 PW3 QE3 NW3 CO3 ST3 Flat Cut LC3 BE3 MH3 MC3 LM3 Solid Color Laminate \$539 Quartered FW3 PN3 WL3 GR3 RW3 BL3	X9 None UR Left Facing UQ Right Facing	X9 None H4K Weighted \$116	QZ Concealed Glide - Standard H1S Caster \$66 H3Z Caster Softwheel \$66 C4Y Wood Leg (specify finish) \$195 QZ Concealed Glide - Standard C4Y Wood Leg (specify finish) \$195 Note: Caster option not available on H4K	Veneer Quartered QEC PWM PCO MGW MRO MGO MNW MSO Flat Cut MFC BUW MBM MLC MSW MHM MMC MVW Paint BLK	Grade, Vendor, Pattern, Color	Grade, Vendor, Pattern, Color

HOW TO ORDER

SPECIFY: Tablet post color | tablet finish | location | weighted | base | finish (if applicable) | top fabric | side fabric.
See pages 5-14 for the designator finish name and graded-in fabric options.

MODEL NUMBER							
C49057							
Tablet Post Color	Tablet Finish	Location	Weighted	Base	Finish (C4Y only)	Top Fabric/Grade	Side Fabric/Grade
X9	X9	X9	X9	QZ		Grade 4, Momentum, Hue, Smoke	Grade 4, Momentum, Hue, Smoke

TRAP OTTOMAN STANDARD FEATURES

- Fully Upholstered
- Concealed Glide (Standard)

Construction:

- Fabricated Structures are Upholstered Utilizing High Resilient Polyurethane Foam for Long-Lasting Support and Comfort

Base:

- Base is Standard with Concealed Glides. Optional Wood Legs are Available.

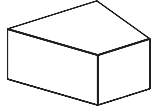

w	outside d	h	sw	seat sd	sh	weight lbs.	cubic feet
36	35.5	17.75	36	35.5	17.75	61	19

model	Top Grade/Fabric yds com (54")	sq ft col	com 1	col 2	3	4	5	6	7	8	9	10	11	12	13	14	15	L1	L2	L3
C49257	1.25	25	281	302	325	354	396	454	513	572	631	690	748	807	866	925	983	553	612	670

model	Side Grade/Fabric yds com (54")	sq ft col	com 1	col 2	3	4	5	6	7	8	9	10	11	12	13	14	15	L1	L2	L3
C49257	2.25	45	507	544	586	639	713	819	925	1,031	1,137	1,242	1,348	1,454	1,560	1,666	1,771	974	1,080	1,185

OPTIONS

Power	Power Faceplate Color	Weighted	Base	Finish (C4Y only)	Top Fabric/Grade	Side Fabric/Grade
X9 None - Standard C5T One Side \$362 C5U Two Sides \$702 C5W Four Sides \$1,401  One Power Outlet Two USB Charging Ports	X9 None BLK Black SLV Silver WHT White	X9 None H4K Weighted \$116	QZ Concealed Glide - Standard C4Y Wood Leg (specify finish) \$195	Veneer <i>Quartered</i> QEC PWM PCO MGW MRO MGO MNW MSO <i>Flat Cut</i> MFC BUW MBM MLC MSW MHM MMC MVW Paint BLK	Grade, Vendor, Pattern, Color	Grade, Vendor, Pattern, Color

HOW TO ORDER

SPECIFY: Power | power faceplate color | weighted | base | finish (if applicable) | top fabric | side fabric.
 See pages 5-14 for the designator finish name and graded-in fabric options.

MODEL NUMBER

C49257

Power	Power Faceplate Color	Weighted	Base	Finish (C4Y only)	Top Fabric/Grade	Side Fabric/Grade
X9	X9	X9	QZ		Grade 4, Momentum, Hue, Smoke	Grade 4, Momentum, Hue, Smoke

TRAP OTTOMAN WITH REMOVABLE TOP STANDARD FEATURES

- Fully Upholstered
- Removable Top for Storage
- Concealed Glide (Standard)

Construction:

- Fabricated Structures are Upholstered Utilizing High Resilient Polyurethane Foam for Long-Lasting Support and Comfort

Base:

- Base is Standard with Concealed Glides. Optional Bases are Available.
- Optional Tablet in Maple Veneer or 3D Laminate



w	outside d	h	sw	seat sd	sh	weight lbs.	cubic feet
20.75	20.25	17.75	20.75	20.25	17.75	29	9

- 18.5"H with H1S, H3Z, C4Y and H3Y Options

model	Top Grade/Fabric yds com (54")	sq ft col	com 1	col 2	3	4	5	6	7	8	9	10	11	12	13	14	15	L1	L2	L3
C49057-R	0.75	15	287	299	313	331	356	391	426	462	497	532	567	603	638	673	708	461	497	532

model	Side Grade/Fabric yds com (54")	sq ft col	com 1	col 2	3	4	5	6	7	8	9	10	11	12	13	14	15	L1	L2	L3
C49057-R	1	20	383	399	418	442	475	522	569	616	663	710	757	804	851	898	945	606	653	700

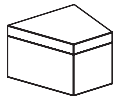

w	outside d	h	sw	seat sd	sh	weight lbs.	cubic feet
25.5	25	17.75	25.5	25	17.75	42	13

- 18.5"H with H1S, H3Z, C4Y and H3Y Options

model	Top Grade/Fabric yds com (54")	sq ft col	com 1	col 2	3	4	5	6	7	8	9	10	11	12	13	14	15	L1	L2	L3
C49157-R	0.75	15	275	287	301	319	344	379	414	450	485	520	555	591	626	661	696	449	485	520

model	Side Grade/Fabric yds com (54")	sq ft col	com 1	col 2	3	4	5	6	7	8	9	10	11	12	13	14	15	L1	L2	L3
C49157-R	1.5	30	550	575	603	638	688	758	829	899	970	1,040	1,111	1,181	1,252	1,322	1,393	870	942	1,011

OPTIONS

Tablet Post Color	Tablet Finish	Base	Finish (C4Y only)	Top Fabric/Grade	Side Fabric/Grade
X9 None BKO Black MSL Luster Grey PAL Polished Aluminum WHT White	X9 None Maple Veneer \$539 Quartered QEC PWM PCO MGW MRO MGO MNW MSO Flat Cut MFC BUW MBM MLC MSW MHM MMC MVW 3D Laminate \$539 Quartered EN3 PW3 QE3 NW3 CO3 ST3 Flat Cut LC3 BE3 MH3 MC3 LM3 Solid Color Laminate \$539 Quartered FW3 PN3 WL3 GR3 RW3 BL3	QZ Concealed Glide - Standard H1S Caster \$66 H3Z Caster Softwheel \$66 C4Y Wood Leg (specify finish) \$195	Veneer Quartered QEC PWM PCO MGW MRO MGO MNW MSO Flat Cut MFC BUW MBM MLC MSW MHM MMC MVW Paint BLK	Grade, Vendor, Pattern, Color	Grade, Vendor, Pattern, Color

HOW TO ORDER

SPECIFY: Tablet post color | tablet finish | base | finish (if applicable) | top fabric | side fabric.
See pages 5-14 for the designator finish name and graded-in fabric options.

MODEL NUMBER

C49057-R

Tablet Post Color	Tablet Finish	Base	Finish (C4Y only)	Top Fabric/Grade	Side Fabric/Grade
X9	X9	QZ		Grade 4, Momentum, Hue, Smoke	Grade 4, Momentum, Hue, Smoke

ARMLESS CHAIR, LOVESEAT AND SOFA STANDARD FEATURES

- Upholstered Back
- Sinuous Springs in Seat
- Wall-Saver Design
- Optional finished Wood Panel - Quartered Grain
- Luster Grey Powder Coat on All Exposed Metal

CHAIR

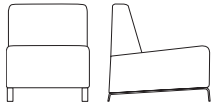

w	outside d	h	sw	seat sd	sh	inside back	arm height	weight lbs.	cubic feet
24.5	30.75	30	24	20	17.5	15	n/a	61	35

model	yds com (54")	sq ft col	com 1	col 2	3	4	5	6	7	8	9	10	11	12	13	14	15	L1	L2	L3
with Upholstered Back (VZ)																				
6010-1 VZ	3	60	1,232	1,281	1,338	1,408	1,507	1,648	1,789	1,930	2,071	2,212	2,354	2,495	2,636	2,777	2,918	1,845	1,987	2,127
with Finished Wood Back (WA)																				
6010-1 WA	2.5	50	1,545	1,586	1,633	1,692	1,774	1,892	2,009	2,127	2,244	2,362	2,480	2,597	2,715	2,832	2,950	2,060	2,179	2,295

LOVESEAT

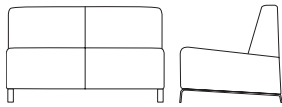

w	outside d	h	sw	seat sd	sh	inside back	arm height	weight lbs.	cubic feet
48.5	30.75	30	48	20	17.5	15	n/a	107	51

model	yds com (54")	sq ft col	com 1	col 2	3	4	5	6	7	8	9	10	11	12	13	14	15	L1	L2	L3
with Upholstered Back (VZ)																				
6010-2 VZ	4.5	90	1,853	1,927	2,012	2,118	2,266	2,477	2,689	2,900	3,112	3,324	3,535	3,747	3,958	4,170	4,382	2,758	2,972	3,181
with Finished Wood Back (WA)																				
6010-2 WA	4	80	2,360	2,426	2,501	2,595	2,727	2,915	3,103	3,291	3,479	3,667	3,855	4,043	4,232	4,420	4,608	3,168	3,357	3,544

SOFA

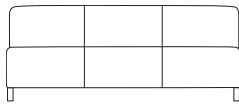

w	outside d	h	sw	seat sd	sh	inside back	arm height	weight lbs.	cubic feet
72.5	30.75	30	72	20	17.5	15	n/a	142	63

model	yds com (54")	sq ft col	com 1	col 2	3	4	5	6	7	8	9	10	11	12	13	14	15	L1	L2	L3
with Upholstered Back (VZ)																				
6010-3 VZ	7	140	2,328	2,443	2,575	2,739	2,970	3,299	3,628	3,957	4,287	4,616	4,945	5,274	5,603	5,932	6,261	3,721	4,053	4,378
with Finished Wood Back (WA)																				
6010-3 WA	5	100	2,680	2,762	2,856	2,974	3,138	3,374	3,609	3,844	4,079	4,314	4,549	4,784	5,019	5,255	5,490	3,683	3,920	4,153

OPTIONS

Powder Coat	Back	Finish (WA Wood Back Only)	Fabric/Grade
MSL Luster Grey - Standard	VZ Upholstered - Standard WA Finished Wood Back Panel (specify finish)	Selection Required	Grade, Vendor, Pattern, Color
BWT Bone White BUFF Buff CHLK Chalk SGLD Gold GRPH Graphite MSL Luster Grey HIP Oiled Bronze BKO Onyx POLR Polar SBRZ Soft Bronze HIF Warm Grey	NOTE: See individual items for prices	See page 9 for full list of finish options	NOTE: For multiple fabric applications see page 14 for information and pricing

HOW TO ORDER

SPECIFY: Powder coat | back | finish (if applicable) | textile pattern and color. When ordering options, a complete description of the option and its upcharge must be detailed on the order form. See pages 5-14 for a complete offering of finishes and graded-in fabric options.

MODEL NUMBER

6010-3

Powder Coat	Back	Finish (WA Wood Back Only)	Fabric/Grade
MSL	WA	MLC	Grade 4, Momentum, Hue, Smoke

CHAIR, LOVESEAT AND SOFA WITH ARMS STANDARD FEATURES

- Upholstered Arms
- Upholstered Back
- Optional finished Wood Panel - Quartered Grain
- Luster Grey Powder Coat on All Exposed Metal
- Sinuous Springs in Seat
- Wall-Saver Design

CHAIR

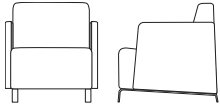

w	outside d	h	sw	seat sd	sh	inside back	arm height	from floor	weight lbs.	cubic feet
28	30.75	30	24	20	17.5	15	7.25	24	85	35

model	yds com (54")	sq ft col	com 1	col 2	3	4	5	6	7	8	9	10	11	12	13	14	15	L1	L2	L3
with Upholstered Back (VZ)																				
6011-1 VZ	5	100	1,697	1,779	1,873	1,991	2,155	2,391	2,626	2,861	3,096	3,331	3,566	3,801	4,036	4,272	4,507	2,700	2,937	3,170
with Finished Wood Back (WA)																				
6011-1 WA	4.5	90	2,049	2,123	2,208	2,314	2,462	2,673	2,885	3,096	3,308	3,520	3,731	3,943	4,154	4,366	4,578	2,954	3,168	3,377

LOVESEAT

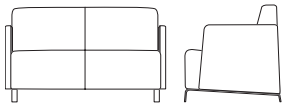

w	outside d	h	sw	seat sd	sh	inside back	arm height	from floor	weight lbs.	cubic feet
52	30.75	30	48	20	17.5	15	7.25	24	131	51

model	yds com (54")	sq ft col	com 1	col 2	3	4	5	6	7	8	9	10	11	12	13	14	15	L1	L2	L3
with Upholstered Back (VZ)																				
6011-2 VZ	6.5	130	2,205	2,312	2,434	3,587	2,801	3,107	3,412	3,718	4,024	4,329	4,365	4,941	5,246	5,552	5,858	3,500	3,808	4,111
with Finished Wood Back (WA)																				
6011-2 WA	5.5	110	2,721	2,812	2,915	3,044	3,225	3,484	3,743	4,001	4,260	4,518	4,477	5,036	5,294	5,554	5,812	3,821	4,082	4,338

SOFA

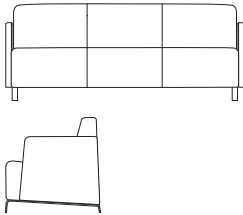

w	outside d	h	sw	seat sd	sh	inside back	arm height	from floor	weight lbs.	cubic feet
76	30.75	30	72	20	17.5	15	7.25	24	166	63

model	yds com (54")	sq ft col	com 1	col 2	3	4	5	6	7	8	9	10	11	12	13	14	15	L1	L2	L3
with Upholstered Back (VZ)																				
6011-3 VZ	8	160	2,642	2,774	2,924	3,112	3,376	3,752	4,128	4,504	4,880	5,256	5,633	6,009	6,385	6,761	7,137	4,230	4,609	4,981
with Finished Wood Back (WA)																				
6011-3 WA	7	140	3,338	3,453	3,585	3,749	3,980	4,309	4,638	4,967	5,297	5,626	5,955	6,284	6,613	6,942	7,271	4,731	5,063	5,388

OPTIONS

Powder Coat	Back	Finish (WA Wood Back Only)	Fabric/Grade
MSL Luster Grey - Standard BWT Bone White BUFF Buff CHLK Chalk SGLD Gold GRPH Graphite MSL Luster Grey HIP Oiled Bronze BKO Onyx POLR Polar SBRZ Soft Bronze HIF Warm Grey	VZ Upholstered - Standard WA Finished Wood Back Panel (specify finish) NOTE: See individual items for prices	Selection Required See page 9 for full list of finish options	Grade, Vendor, Pattern, Color NOTE: For multiple fabric applications see page 14 for information and pricing

HOW TO ORDER

SPECIFY: Powder coat | back | finish (if applicable) | textile pattern and color. When ordering options, a complete description of the option and its upcharge must be detailed on the order form. See pages 5-14 for a complete offering of finishes and graded-in fabric options.

MODEL NUMBER

6011-3

Powder Coat	Back	Finish (WA Wood Back Only)	Fabric/Grade
MSL	WA	MLC	Grade 4, Momentum, Hue, Smoke

CHAIR, LOVESEAT AND SOFA WITH METAL ARMS STANDARD FEATURES

- Metal Arms without Arm Caps
- Upholstered Back
- Optional finished Wood Panel - Quartered Grain
- Luster Grey Powder Coat on All Exposed Metal
- Sinuous Springs in Seat
- Wall-Saver Design

CHAIR

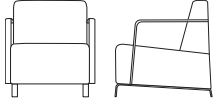

w	outside d	h	sw	seat sd	sh	inside back	arm height	from floor	weight lbs.	cubic feet
27.25	30.75	30	24	20	17.5	15	7	23.75	75	35

model	yds com (54")	sq ft col	com 1	col 2	3	4	5	6	7	8	9	10	11	12	13	14	15	L1	L2	L3
with Upholstered Back (VZ)																				
6012-1 VZ	3	60	1,533	1,582	1,639	1,709	1,808	1,949	2,009	2,231	2,372	2,513	2,655	2,797	2,937	3,078	3,219	2,146	2,288	2,428
with Finished Wood Back (WA)																				
6012-1 WA	2.5	50	1,872	1,913	1,960	2,019	2,101	2,219	2,336	2,454	2,571	2,689	2,807	2,924	3,042	3,159	3,277	2,387	2,506	2,622

LOVESEAT

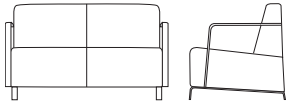

w	outside d	h	sw	seat sd	sh	inside back	arm height	from floor	weight lbs.	cubic feet
51.25	30.75	30	48	18	17.5	15	7	23.75	121	51

model	yds com (54")	sq ft col	com 1	col 2	3	4	5	6	7	8	9	10	11	12	13	14	15	L1	L2	L3
with Upholstered Back (VZ)																				
6012-2 VZ	4.5	90	2,124	2,198	2,283	2,389	2,537	2,748	2,960	3,171	3,383	3,595	3,806	4,018	4,229	4,441	4,653	3,029	3,243	3,452
with Finished Wood Back (WA)																				
6012-2 WA	4	80	2,654	2,720	2,795	2,889	3,021	3,209	3,397	3,585	3,773	3,961	4,149	4,337	4,526	4,714	4,902	3,462	3,651	3,838

SOFA

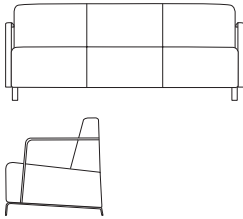

w	outside d	h	sw	seat sd	sh	inside back	arm height	from floor	weight lbs.	cubic feet
75.25	30.75	30	72	18	17.5	15	7	23.75	156	63

model	yds com (54")	sq ft col	com 1	col 2	3	4	5	6	7	8	9	10	11	12	13	14	15	L1	L2	L3
with Upholstered Back (VZ)																				
6012-3 VZ	7	140	2,457	2,572	2,704	2,868	3,099	3,428	3,757	4,086	4,416	4,745	5,074	5,403	5,732	6,061	6,390	3,850	4,182	4,507
with Finished Wood Back (WA)																				
6012-3 WA	5	100	3,096	3,178	3,272	3,390	3,554	4,790	4,025	4,260	4,495	4,730	4,965	5,200	5,435	5,671	5,906	4,099	4,336	4,569

OPTIONS

Powder Coat	Arm Caps	Back	Finish (WD and WA only)	Fabric/Grade
MSL Luster Grey - Standard BWT Bone White BUFF Buff CHLK Chalk SGLD Gold GRPH Graphite MSL Luster Grey HIP Oiled Bronze BKO Onyx POLR Polar SBRZ Soft Bronze HIF Warm Grey	X9 No Arm Caps - Standard WC Upholstered \$89 WD Finished Wood (specify finish) \$89 Solid Surface \$110 pair CWS Cameo White MWS Modern White CSS Concrete DMS Deep Mink	VZ Upholstered - Standard WA Finished Wood Back Panel (specify finish) NOTE: See individual items for prices	Selection Required See page 9 for full list of finish options	Grade, Vendor, Pattern, Color NOTE: For multiple fabric applications see page 14 for information and pricing

HOW TO ORDER

SPECIFY: Powder Coat | arm caps | back | finish (if applicable) | textile pattern and color. When ordering options, a complete description of the option and its upcharge must be detailed on the order form. See pages 5-14 for a complete offering of finishes and graded-in fabric options.

MODEL NUMBER

6012-3

Powder Coat	Arm Caps	Back	Finish (WD and WA only)	Fabric/Grade
MSL	WD	WA	MLC	Grade 4, Momentum, Hue, Smoke

BENCHES STANDARD FEATURES

- Fully Upholstered
- Luster Grey Powder Coat on All Exposed Metal
- Sinuous Springs in Seat
- Wall-Saver Design

SINGLE SEAT



w	outside d	h	sw	seat sd	sh	inside back	arm height	weight lbs.	cubic feet
22.25	24	18.5	22.25	20	18.5	n/a	n/a	66	16

model	yds com (54")	sq ft col	com 1	col 2	3	4	5	6	7	8	9	10	11	12	13	14	15	L1	L2	L3
6013-1	1.75	35	1,062	1,091	1,124	1,165	1,222	1,305	1,387	1,469	1,552	1,634	1,716	1,798	1,881	1,963	2,045	1,431	1,514	1,596

TWO SEAT



w	outside d	h	sw	seat sd	sh	inside back	arm height	weight lbs.	cubic feet
44.25	24	18.5	44.25	20	18.5	n/a	n/a	96	51

model	yds com (54")	sq ft col	com 1	col 2	3	4	5	6	7	8	9	10	11	12	13	14	15	L1	L2	L3
6013-2	2.25	45	1,528	1,565	1,607	1,660	1,734	1,840	1,946	2,052	2,158	2,263	2,369	2,245	2,581	2,687	2,792	1,995	2,101	2,206

THREE SEAT

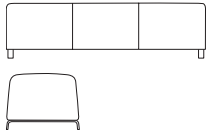

w	outside d	h	sw	seat sd	sh	inside back	arm height	weight lbs.	cubic feet
66.25	24	18.5	66.25	20	18.5	n/a	n/a	127	63

model	yds com (54")	sq ft col	com 1	col 2	3	4	5	6	7	8	9	10	11	12	13	14	15	L1	L2	L3
6013-3	3.25	65	1,765	1,818	1,880	1,956	2,063	2,216	2,369	2,521	2,674	2,827	2,980	3,133	3,286	3,438	3,591	2,427	2,581	2,732

OPTIONS

Powder Coat	Fabric/Grade
MSL Luster Grey - Standard	Grade, Vendor, Pattern, Color
BWT Bone White BUFF Buff CHLK Chalk SGLD Gold GRPH Graphite MSL Luster Grey HIP Oiled Bronze BKO Onyx POLR Polar SBRZ Soft Bronze HIF Warm Grey	NOTE: For multiple fabric applications see page 14 for information and pricing

HOW TO ORDER

SPECIFY: Powder coat | textile pattern and color. When ordering options, a complete description of the option and its upcharge must be detailed on the order form. See pages 5-14 for a complete offering of finishes and graded-in fabric options.

MODEL NUMBER

6013-3

Powder Coat	Fabric/Grade
MSL	Grade 4, Momentum, Hue, Smoke

ELANI LOUNGE STANDARD FEATURES

- Fully Upholstered
- Wall-Saver Design
- Non-Marring Adjustable Glides
- Sculpted American Ash Wood Legs
- Tight Cushion
- Shelter Back Available

LOUNGE CHAIR

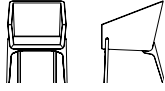

w	outside d	h	sw	seat sd	sh	weight lbs.	cubic feet
26	30.25	32.5	20	19	18	22	13.3

model	yds com (54")	sq ft col	com 1	col 2	3	4	5	6	7	8	9	10	11	12	13	14	15	L1	L2	L3
480-1	3.25	n/a	2,149	2,202	2,264	2,340	2,447	2,600	2,753	2,905	3,058	3,211	3,364	3,517	3,670	3,822	3,975	2,811	2,965	3,116

SETTEE

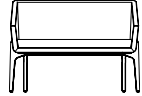

w	outside d	h	sw	seat sd	sh	weight lbs.	cubic feet
45.75	30.25	32.5	40	19	18	40.5	23.7

model	yds com (54")	sq ft col	com 1	col 2	3	4	5	6	7	8	9	10	11	12	13	14	15	L1	L2	L3
480-2	4	n/a	2,549	2,615	2,690	2,784	2,916	3,104	3,292	3,480	3,668	3,856	4,044	4,232	4,421	4,609	4,797	3,357	3,546	3,733

OPTIONS

Arm Cap	Finish	Ferrules	Fabric 1
<p>X9 None - Standard</p> <p>Wood \$130 pair Specify Finish</p> <p>Poly \$110 pair DIN Black DIM Taupe DIP Grey</p> <p>Solid Surface \$230 pair CWS Cameo White MWS Modern White CSS Concrete DMS Deep Mink</p>	<p>Selection Required</p> <p>See page 9 for full list of finish options</p>	<p>X9 None - Standard</p> <p>Metal Ferrules \$146 BWT Bone White BUF Buff CHLK Chalk SGLD Gold GRPH Graphite MSL Luster Grey HIP Oiled Bronze BKO Onyx POLR Polar SBRZ Soft Bronze H2F Warm Grey</p> <p><i>Studio Powder Coat (10% upcharge)</i> CADT Cadet CLOV Clover GLDN Goldenrod HERN Heron LATT Latte MOSS Moss RUSS Russet SUNS Sunset</p>	<p>Grade, Vendor, Pattern, Color</p> <p>NOTE: For multiple fabric application see page 14 for information and pricing</p>

HOW TO ORDER

SPECIFY: Arm Caps | Finish | Ferrules | Fabric

MODEL NUMBER

480-1

Arm Cap	Finish	Ferrules	Fabric 1
X9	MNW	MSL	Grade 4, Momentum, Hue, Smoke

ELANI LOUNGE STANDARD FEATURES

- Fully Upholstered
- Wall-Saver Design
- Non-Marring Adjustable Glides
- Sculpted American Ash Wood Legs
- Tight Cushion
- Low Back Lounge Available

SHELTER BACK LOUNGE CHAIR

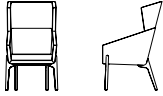

w	outside d	h	sw	seat sd	sh	weight lbs.	cubic feet
26	30.25	46	20	19	18	27	18.8

model	yds com (54")	sq ft col	com 1	col 2	3	4	5	6	7	8	9	10	11	12	13	14	15	L1	L2	L3
480-1H	4.75	n/a	2,649	2,727	2,817	2,928	3,085	3,308	3,531	3,755	3,978	4,201	4,425	4,648	4,871	5,095	5,318	3,603	3,828	4,049

SHELTER BACK SETTEE

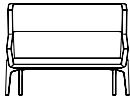

w	outside d	h	sw	seat sd	sh	weight lbs.	cubic feet
45.5	30.5	46	20	19	18	27	18.8

model	yds com (54")	sq ft col	com 1	col 2	3	4	5	6	7	8	9	10	11	12	13	14	15	L1	L2	L3
480-2H	6.5	n/a	3,049	3,156	3,278	3,431	3,645	4,951	4,256	4,562	5,868	5,173	5,479	5,785	6,090	6,396	6,702	4,344	4,952	4,955

OPTIONS

Arm Cap	Finish	Ferrules	Fabric 1
<p>X9 None - Standard</p> <p>Wood \$130 pair Specify Finish</p> <p>Poly \$110 pair DIN Black DIM Taupe DIP Grey</p> <p>Solid Surface \$230 pair CWS Cameo White MWS Modern White CSS Concrete DMS Deep Mink</p>	<p>Selection Required</p> <p>See page 9 for full list of finish options</p>	<p>X9 None - Standard</p> <p>Metal Ferrules \$146 BWT Bone White BUF Buff CHLK Chalk SGLD Gold GRPH Graphite MSL Luster Grey HIP Oiled Bronze BKO Onyx POLR Polar SBRZ Soft Bronze H2F Warm Grey</p> <p><i>Studio Powder Coat (10% upcharge)</i> CADT Cadet CLOV Clover GLDN Goldenrod HERN Heron LATT Latte MOSS Moss RUSS Russet SUNS Sunset</p>	<p>Grade, Vendor, Pattern, Color</p> <p>NOTE: For multiple fabric application see page 14 for information and pricing</p>

HOW TO ORDER

SPECIFY: Arm Caps | Finish | Ferrules | Fabric

MODEL NUMBER

480-1H

Arm Cap	Finish	Ferrules	Fabric 1
X9	MNW	MSL	Grade 4, Momentum, Hue, Smoke

EMBRACE EXPOSED WOOD TRIM ARMS LOUNGE STANDARD FEATURES

- European Beech Trimmed Upholstered Arms
- Upholstered Seat and Back with Cross Seam Detail on Back
- Tight Cushion
- European Beech Exposed Wood Skirt with Tapered Legs
- Tack-In Non-Marring Glide

CHAIR, EXPOSED WOOD TRIM ARMS

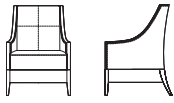

w	outside d	h	sw	seat sd	sh	seat to top of back	arm height	weight lbs.	cubic feet
30	31	42	26.5	20	20	25	25	95	38

model	yds com (54")	sq ft col	com 1	col 2	3	4	5	6	7	8	9	10	11	12	13	14	15	L1	L2	L3
EFC1010-1	5	n/a	2,228	2,310	2,404	2,522	2,686	2,922	3,157	3,392	3,627	3,862	4,097	4,332	4,567	4,803	5,038	3,231	3,468	3,701

SETTEE, EXPOSED WOOD TRIM ARMS



w	outside d	h	sw	seat sd	sh	seat to top of back	arm height	weight lbs.	cubic feet
57	31	42	54	20	20	25	25	180	58

model	yds com (54")	sq ft col	com 1	col 2	3	4	5	6	7	8	9	10	11	12	13	14	15	L1	L2	L3
EFC1010-2	8	n/a	2,885	3,017	3,167	3,355	3,619	3,995	4,371	4,747	5,123	5,499	5,876	6,252	6,628	7,004	7,380	4,473	4,852	5,224

SOFA, EXPOSED WOOD TRIM ARMS

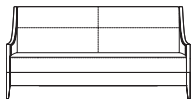

w	outside d	h	sw	seat sd	sh	seat to top of back	arm height	weight lbs.	cubic feet
84	31	42	80.5	20	20	25	25	270	77

model	yds com (54")	sq ft col	com 1	col 2	3	4	5	6	7	8	9	10	11	12	13	14	15	L1	L2	L3
EFC1010-3	9.75	n/a	3,524	3,684	3,868	4,097	4,418	4,877	5,335	5,793	6,252	6,710	7,169	7,627	8,086	8,544	9,003	5,453	5,915	6,369

OPTIONS

Bumper Rail	Finish	Fabric 1
Standard X9 No Selection of Option	Selection Required	Selection Required
D1K Brushed Aluminum Chair \$234 Settee \$283 Sofa \$339	See page 9 for full list of finish options	Fabric: Grade, Vendor, Pattern, Color NOTE: For multiple fabric applications see page 14 for information and pricing

HOW TO ORDER

SPECIFY: Bumper rail | wood finish | textile pattern and color. See pages 5-14 for information and options on moisture barrier, CAL133, upholstery applications, a complete offering of finishes and ordering details.

MODEL NUMBER

EFC1010-1

Bumper Rail	Finish	Fabric 1
D1K	MLC	Grade 5, Momentum, Row, Breeze

EMBRACE FULLY UPHOLSTERED ARMS LOUNGE STANDARD FEATURES

- Upholstered Arms, Seat and Back
- Cross Seam Detail on Back
- Tight Cushion
- European Beech Exposed Wood Skirt with Tapered Legs
- Tack-In Non-Marring Glide

CHAIR, FULLY UPHOLSTERED ARMS

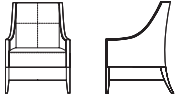

w	outside			sw	seat			seat to top of back							arm height	weight lbs.	cubic feet
	d	h		sd	sh												
30	31	42		26.5	20	20								25	95	38	

model	yds com (54")	sq ft col	com 1	col 2	3	4	5	6	7	8	9	10	11	12	13	14	15	L1	L2	L3
EFC1011-1	5	n/a	2,201	2,283	2,377	2,495	2,659	2,895	3,130	3,365	3,600	3,835	4,070	4,305	4,540	4,776	5,011	3,204	3,441	3,674

SETTEE, FULLY UPHOLSTERED ARMS

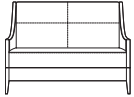

w	outside			sw	seat			seat to top of back							arm height	weight lbs.	cubic feet
	d	h		sd	sh												
57	31	42		54	20	20								25	180	58	

model	yds com (54")	sq ft col	com 1	col 2	3	4	5	6	7	8	9	10	11	12	13	14	15	L1	L2	L3
EFC1011-2	7.5	n/a	2,853	2,976	3,118	3,294	3,541	3,893	4,246	4,599	4,951	5,304	5,657	6,009	6,362	6,715	7,067	4,343	4,699	5,048

SOFA, FULLY UPHOLSTERED ARMS

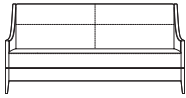

w	outside			sw	seat			seat to top of back							arm height	weight lbs.	cubic feet
	d	h		sd	sh												
84	31	42		80.5	20	20								25	270	77	

model	yds com (54")	sq ft col	com 1	col 2	3	4	5	6	7	8	9	10	11	12	13	14	15	L1	L2	L3
EFC1011-3	9.75	n/a	3,492	3,652	3,836	4,065	4,386	4,845	5,303	5,761	6,220	6,678	7,137	7,595	8,054	8,512	8,971	5,421	5,883	6,337

OPTIONS

Bumper Rail	Finish	Fabric 1
Standard X9 No Selection of Option	Selection Required	Selection Required
D1K Brushed Aluminum Chair \$234 Settee \$283 Sofa \$339	See page 9 for full list of finish options	Fabric: Grade, Vendor, Pattern, Color NOTE: For multiple fabric applications see page 14 for information and pricing

HOW TO ORDER

SPECIFY: Bumper rail | wood finish | textile pattern and color. See pages 5-14 for information and options on moisture barrier, CAL133, upholstery applications, a complete offering of finishes and ordering details.

MODEL NUMBER

EFC1011-1

Bumper Rail	Finish	Fabric 1
D1K	MLC	Grade 5, Momentum, Row, Breeze

EMBRACE OPEN ARMS LOUNGE STANDARD FEATURES

- Upholstered Seat and Back with Cross Seam Detail on Back
- Tight Cushion
- European Beech Trimmed Arms with an Open Arm Frame
- European Beech Exposed Wood Skirt with Tapered Legs
- Tack-In Non-Marring Glide

CHAIR, OPEN ARMS

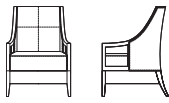

w	outside d	h	sw	seat sd	sh	seat to top of back	arm height	weight lbs.	cubic feet
30	31	42	26.5	20	20	25	25	90	38

model	yds com (54")	sq ft col	com 1	col 2	3	4	5	6	7	8	9	10	11	12	13	14	15	L1	L2	L3
EFC1012-1	4.75	n/a	2,273	2,351	2,441	2,552	2,709	2,932	3,155	3,379	3,602	3,825	4,049	4,272	4,495	4,719	4,942	3,227	3,452	3,673

SETTEE, OPEN ARMS

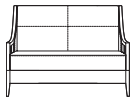

w	outside d	h	sw	seat sd	sh	seat to top of back	arm height	weight lbs.	cubic feet
57	31	42	54	20	20	25	25	180	58

model	yds com (54")	sq ft col	com 1	col 2	3	4	5	6	7	8	9	10	11	12	13	14	15	L1	L2	L3
EFC1012-2	7.5	n/a	3,021	3,144	3,286	3,462	3,709	4,061	4,414	4,767	5,119	5,472	5,825	6,177	6,530	6,883	7,235	4,511	4,867	5,216

SOFA, OPEN ARMS

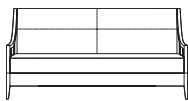

w	outside d	h	sw	seat sd	sh	seat to top of back	arm height	weight lbs.	cubic feet
84	31	42	80.5	20	20	25	25	270	77

model	yds com (54")	sq ft col	com 1	col 2	3	4	5	6	7	8	9	10	11	12	13	14	15	L1	L2	L3
EFC1012-3	9.5	n/a	3,679	3,835	4,014	4,237	4,550	4,997	5,444	5,890	6,337	6,784	7,230	7,677	8,124	8,571	9,017	5,559	6,009	6,452

OPTIONS

Bumper Rail	Finish	Fabric 1
Standard X9 No Selection of Option	Selection Required	Selection Required
D1K Brushed Aluminum Chair \$234 Settee \$283 Sofa \$339	See page 9 for full list of finish options	Fabric: Grade, Vendor, Pattern, Color NOTE: For multiple fabric applications see page 14 for information and pricing

HOW TO ORDER

SPECIFY: Bumper rail | wood finish | textile pattern and color. See pages 5-14 for information and options on moisture barrier, CAL133, upholstery applications, a complete offering of finishes and ordering details.

MODEL NUMBER

EFC1012-1

Bumper Rail	Finish	Fabric 1
D1K	MLC	Grade 5, Momentum, Row, Breeze

EMBRACE EXPOSED WOOD ARMS LOUNGE STANDARD FEATURES

- European Beech Trimmed Upholstered Arms
- Upholstered Back
- Tight Cushion
- Waterfall Upholstered Seat and Front Panel with European Beech Exposed Wood Skirt on Sides and Back
- Tapered European Beech Legs
- Tack-In Non-Marring Glide

CHAIR, EXPOSED WOOD TRIM ARMS

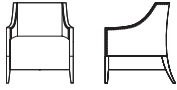

w	outside			sw	seat			seat to top of back	arm height	weight lbs.	cubic feet
	d	h			sd	sh					
30	31	36		26.5	20	20	17.5	25	90	27	

model	yds com (54")	sq ft col	com 1	col 2	3	4	5	6	7	8	9	10	11	12	13	14	15	L1	L2	L3
EFC1020-1	5	n/a	2,143	2,225	2,319	2,437	2,601	2,837	3,072	3,307	3,542	3,777	4,012	4,247	4,482	4,718	4,953	3,146	3,383	3,616

SETTEE, EXPOSED WOOD TRIM ARMS

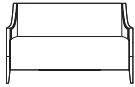

w	outside			sw	seat			seat to top of back	arm height	weight lbs.	cubic feet
	d	h			sd	sh					
57	31	36		54	20	20	17.5	25	170	53	

model	yds com (54")	sq ft col	com 1	col 2	3	4	5	6	7	8	9	10	11	12	13	14	15	L1	L2	L3
EFC1020-2	8	n/a	2,800	2,932	3,082	3,270	3,534	3,910	4,286	4,662	5,038	5,414	5,791	6,167	6,543	6,919	7,295	4,388	4,767	5,139

SOFA, EXPOSED WOOD TRIM ARMS

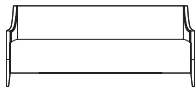

w	outside			sw	seat			seat to top of back	arm height	weight lbs.	cubic feet
	d	h			sd	sh					
84	31	36		80.5	20	20	17.5	25	260	66	

model	yds com (54")	sq ft col	com 1	col 2	3	4	5	6	7	8	9	10	11	12	13	14	15	L1	L2	L3
EFC1020-3	9.75	n/a	3,459	3,619	3,803	4,032	4,353	4,812	5,270	5,728	6,187	6,645	7,104	7,562	8,021	8,479	8,938	5,388	5,850	6,304

OPTIONS

Bumper Rail	Finish	Fabric 1
Standard X9 No Selection of Option	Selection Required	Selection Required
D1K Brushed Aluminum Chair \$234 Settee \$283 Sofa \$339	See page 9 for full list of finish options	Fabric: Grade, Vendor, Pattern, Color NOTE: For multiple fabric applications see page 14 for information and pricing

HOW TO ORDER

SPECIFY: Bumper rail | wood finish | textile pattern and color. See pages 5-14 for information and options on moisture barrier, CAL133, upholstery applications, a complete offering of finishes and ordering details.

MODEL NUMBER

EFC1020-1

Bumper Rail	Finish	Fabric 1
D1K	MLC	Grade 5, Momentum, Row, Breeze

EMBRACE FULLY UPHOLSTERED ARMS LOUNGE STANDARD FEATURES

- Upholstered Arms and Back
- Tight Cushion
- Waterfall Upholstered Seat and Front Panel with European Beech Exposed Wood Skirt on Sides and Back
- Tapered European Beech Legs
- Tack-In Non-Marring Glide

CHAIR, FULLY UPHOLSTERED ARMS

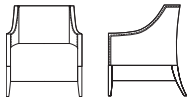

w	outside d	h	sw	seat sd	sh	seat to top of back	arm height	weight lbs.	cubic feet
30	31	36	26.5	20	20	17.5	25	90	27

model	yds com (54")	sq ft col	com 1	col 2	3	4	5	6	7	8	9	10	11	12	13	14	15	L1	L2	L3
EFC1021-1	5	n/a	2,040	2,122	2,216	2,334	2,498	2,734	2,969	3,204	3,439	3,674	3,909	4,144	4,379	4,615	4,850	3,043	3,280	3,513

SETTEE, FULLY UPHOLSTERED ARMS

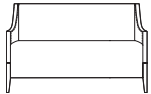

w	outside d	h	sw	seat sd	sh	seat to top of back	arm height	weight lbs.	cubic feet
57	31	36	54	20	20	17.5	25	170	53

model	yds com (54")	sq ft col	com 1	col 2	3	4	5	6	7	8	9	10	11	12	13	14	15	L1	L2	L3
EFC1021-2	8	n/a	2,606	2,738	2,888	3,076	3,340	3,716	4,092	4,468	4,844	5,220	5,597	5,973	6,349	6,725	7,101	4,194	4,573	4,945

SOFA, FULLY UPHOLSTERED ARMS



w	outside d	h	sw	seat sd	sh	seat to top of back	arm height	weight lbs.	cubic feet
84	31	36	80.5	20	20	17.5	25	260	66

model	yds com (54")	sq ft col	com 1	col 2	3	4	5	6	7	8	9	10	11	12	13	14	15	L1	L2	L3
EFC1021-3	9.75	n/a	3,135	3,295	3,479	3,708	4,029	4,488	4,946	5,404	5,863	6,321	6,780	7,238	7,697	8,155	8,614	5,064	5,526	5,980

OPTIONS

Bumper Rail	Finish	Fabric 1
Standard X9 No Selection of Option	Selection Required	Selection Required
D1K Brushed Aluminum Chair \$234 Settee \$283 Sofa \$339	See page 9 for full list of finish options	Fabric: Grade, Vendor, Pattern, Color NOTE: For multiple fabric applications see page 14 for information and pricing

HOW TO ORDER

SPECIFY: Bumper rail | wood finish | textile pattern and color. See pages 5-14 for information and options on moisture barrier, CAL133, upholstery applications, a complete offering of finishes and ordering details.

MODEL NUMBER

EFC1021-1

Bumper Rail	Finish	Fabric 1
D1K	MLC	Grade 5, Momentum, Row, Breeze

EMBRACE BENCH STANDARD FEATURES

- European Beech End Panels with Tapered Legs
- European Beech Sliding Table with four Brushed Aluminum Non-Locking Casters on EFC1052
- Bolsters Attached with D-Ring and Elastic Straps on EFC1059
- European Beech Fixed Table with Tapered Legs on EFC105
- Nail in Chrome Glide

BENCH WITH FIXED TABLE

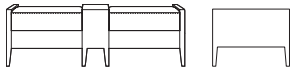

w	outside			h	sw	seat (two)		sh	seat to top of back	arm height	table width	table height	weight lbs.	cubic feet
	d					sd								
60	24			19	24	25		18.5	n/a	25	9	24	130	26

model	yds com (54")	sq ft col	com 1	col 2	3	4	5	6	7	8	9	10	11	12	13	14	15	L1	L2	L3
EFC1051	2.25	n/a	2,081	2,118	2,160	2,213	2,287	2,393	2,499	2,605	2,711	2,816	2,922	3,028	3,134	3,240	3,345	2,548	2,654	2,759

BENCH WITH SLIDING TABLE

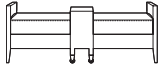

w	outside			h	sw	seat sd	sh	seat to top of back	arm height	table width	table height	weight lbs.	cubic feet
	d												
60	28			24.5	57	25	18.5	n/a	24.5	9	24.5	125	32

model	yds com (54")	sq ft col	com 1	col 2	3	4	5	6	7	8	9	10	11	12	13	14	15	L1	L2	L3
EFC1052	2	n/a	2,230	2,263	2,301	2,348	2,413	2,507	2,601	2,696	2,790	2,884	2,978	3,072	3,166	3,260	3,354	2,648	2,743	2,836

BENCH WITH BOLSTERS

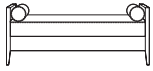

w	outside			h	sw	seat sd	sh	seat to top of back	arm height	weight lbs.	cubic feet
	d										
60	24			24	57	25	18.5	n/a	24.5	125	32

model	yds com (54")	sq ft col	com 1	col 2	3	4	5	6	7	8	9	10	11	12	13	14	15	L1	L2	L3
EFC1059	2.5	n/a	2,056	2,097	2,144	2,203	2,285	2,403	2,520	2,638	2,755	2,873	2,991	3,108	3,226	3,343	3,461	2,571	2,690	2,806

OPTIONS

Bumper Rail	Finish	Fabric 1	Fabric 2 (Bolster - EFC1059 only)
Standard X9 No Selection of Option	Selection Required	Selection Required	Selection Required
D1K Brushed Aluminum Bench \$284	See page 9 for full list of finish options	Fabric: Grade, Vendor, Pattern, Color NOTE: For multiple fabric applications see page 14 for information and pricing	Fabric: Grade, Vendor, Pattern, Color NOTE: For multiple fabric applications see page 14 for information and pricing

HOW TO ORDER

SPECIFY: Bumper rail | wood finish | textile 1 pattern and color for bench | textile 2 pattern and color for bolsters (if applicable). See pages 5-14 for information and options on moisture barrier, CAL133, upholstery applications, a complete offering of finishes and ordering details.

MODEL NUMBER

EFC1059

Bumper Rail	Finish	Fabric 1	Fabric 2 (Bolster - EFC1059 only)
D1K	MLC	Grade 5, Momentum, Row, Breeze	Grade 5, Momentum, Row, Breeze

HIDE LOUNGE STANDARD FEATURES

- Clean-Thru Design
- Upholstered Arms, Seat and Back
- Spring Seat
- Non-Removable Seat Cushion
- Tapered European Beech Legs
- Tack-In Non-Marring Glide

CHAIR

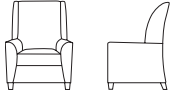

w	outside d	h	sw	seat sd	sh	seat to top of back	arm height	weight lbs.	cubic feet
33.5	33.5	45	21	21	19.5	25.5	24	80	35

model	yds com (54")	sq ft col	com 1	col 2	3	4	5	6	7	8	9	10	11	12	13	14	15	L1	L2	L3
678-1	7	n/a	2,199	2,314	2,446	2,610	2,841	3,170	3,499	3,828	4,158	4,487	4,816	5,145	5,474	5,803	6,132	3,592	3,924	4,249

LOVESEAT

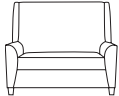

w	outside d	h	sw	seat sd	sh	seat to top of back	arm height	weight lbs.	cubic feet
54.5	33.5	45	42	21	19.5	25.5	24	150	50

model	yds com (54")	sq ft col	com 1	col 2	3	4	5	6	7	8	9	10	11	12	13	14	15	L1	L2	L3
678-2	9	n/a	2,857	3,005	3,174	3,386	3,682	4,105	4,529	4,952	5,375	5,798	6,222	6,645	7,068	7,491	7,914	4,640	5,066	5,485

OPTIONS

Finish	Fabric 1
Selection Required	Selection Required
See page 9 for full list of finish options	Fabric: Grade, Vendor, Pattern, Color NOTE: For multiple fabric applications see page 14 for information and pricing

HOW TO ORDER

SPECIFY: Wood finish | textile pattern and color. See pages 5-14 for information and options on moisture barrier, CAL133, upholstery applications, a complete offering of finishes and ordering details.

MODEL NUMBER

678-1

Finish	Fabric 1
MLC	Grade 5, Momentum, Row, Breeze

INTERLUDE LOUNGE STANDARD FEATURES

- Clean-Thru Design
- Upholstered Arms, Seat and Back
- Tight Cushion
- Curved Upholstered Front Panel for Easy Egress
- Legs 1" x 2" 16 Gauge Powder Coated Rectangular Tubing
- Steel Frame Seat Structure
- Non-Marring Adjustable Glides

CHAIR

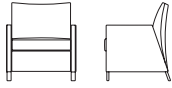

w	outside			sw	seat			seat to top of back	arm height	weight lbs.	cubic feet
	d	h			sd	sh					
30	28	33.5		25	20	18.5	15	25.5	75	27	

model	yds com (54")	sq ft col	com 1	col 2	3	4	5	6	7	8	9	10	11	12	13	14	15	L1	L2	L3
921-1	5	n/a	1,937	2,019	2,113	2,231	2,395	2,631	2,866	3,101	3,336	3,571	3,806	4,041	4,276	4,512	4,747	2,940	3,177	3,410

LOVESEAT

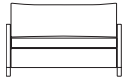

w	outside			sw	seat			seat to top of back	arm height	weight lbs.	cubic feet
	d	h			sd	sh					
53	28	33.5		49	20	18.5	15	25.5	90	44	

model	yds com (54")	sq ft col	com 1	col 2	3	4	5	6	7	8	9	10	11	12	13	14	15	L1	L2	L3
921-2	7	n/a	2,550	2,665	2,797	2,961	3,192	3,521	3,850	4,179	4,509	4,838	5,167	5,496	5,825	6,154	6,483	3,943	4,275	4,600

SOFA

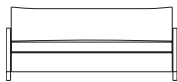

w	outside			sw	seat			seat to top of back	arm height	weight lbs.	cubic feet
	d	h			sd	sh					
78	28	33.5		74	20	18.5	15	25.5	120	66	

model	yds com (54")	sq ft col	com 1	col 2	3	4	5	6	7	8	9	10	11	12	13	14	15	L1	L2	L3
921-3	9	n/a	3,114	3,262	3,431	3,643	3,939	4,362	4,786	5,209	5,632	6,055	6,479	6,902	7,325	7,748	8,171	4,897	5,323	5,742

OPTIONS

Arm Caps	Powder Coat	Fabric 1
Standard	Selection Required	Selection Required
X9 No Arm Cap		
A4 Poly (Black) \$231 pair A3 Wood (specify finish) \$263 pair	BWT Bone White BUFF Buff CHLK Chalk SGLD Gold GRPH Graphite MSL Luster Grey HIP Oiled Bronze BKO Onyx POLR Polar SBRZ Soft Bronze HIF Warm Grey	Fabric: Grade, Vendor, Pattern, Color NOTE: For multiple fabric applications see page 14 for information and pricing

HOW TO ORDER

SPECIFY: Arm cap | arm cap finish (if applicable) | powder coat | textile pattern and color. See pages 5-14 for information and options on moisture barrier, CAL133, upholstery applications, a complete offering of finishes and ordering details.

MODEL NUMBER

921-1

Arm Caps	Powder Coat	Fabric 1
A3 - MLC	BWT	Grade 5, Momentum, Row, Breeze

MODERN AMENITY LOW BACK, UPHOLSTERED ARM LOUNGE STANDARD FEATURES

- Upholstered Arms, Seat and Back
- Upholstered Arm without Arm Cap is Standard
- Spring Seat Construction
- Tight Cushion
- Specify European Beech or American Ash Exposed Wood
- Wall-Saver Design
- Non-Marring Adjustable Glides
- Field Replaceable Components
- Clean-Thru Design
- NOTE: Because of the unique Color of Ash Hardwoods, Stains are a slightly different Color than they appear on the Standard European Beech Hardwoods. If pairing with a Product using Species other than Ash the Stains will appear different. For additional information please contact your Customer Service Representative.

LOW BACK, UPHOLSTERED ARM LOUNGE CHAIR



w	outside			sw	seat			seat to top of back	arm height	weight lbs.	cubic feet
	d	h			sd	sh					
29	33	34		24	22	17	17	25.25	62	27	

model	yds com (54")	sq ft col	com 1	col 2	3	4	5	6	7	8	9	10	11	12	13	14	15	L1	L2	L3
310-1	4.25	n/a	1,783	1,853	1,933	2,033	2,173	2,373	2,572	2,772	2,972	3,172	3,372	3,572	3,771	3,971	4,171	2,640	2,841	3,039

LOW BACK, UPHOLSTERED ARM LOVESEAT

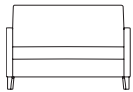

w	outside			sw	seat			seat to top of back	arm height	weight lbs.	cubic feet
	d	h			sd	sh					
50	33	34		44.5	22	17	17	25.25	92	40	

model	yds com (54")	sq ft col	com 1	col 2	3	4	5	6	7	8	9	10	11	12	13	14	15	L1	L2	L3
310-2	6.25	n/a	2,306	2,409	2,526	2,673	2,879	3,173	3,467	3,761	4,055	4,349	4,642	4,936	5,230	5,524	5,818	3,553	3,849	4,140

LOW BACK, UPHOLSTERED ARM SOFA

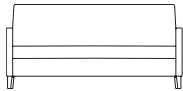

w	outside			sw	seat			seat to top of back	arm height	weight lbs.	cubic feet
	d	h			sd	sh					
70	33	34		65	22	17	17	25.25	124	48	

model	yds com (54")	sq ft col	com 1	col 2	3	4	5	6	7	8	9	10	11	12	13	14	15	L1	L2	L3
310-3	8	n/a	2,711	2,843	2,993	3,181	3,445	3,821	4,197	4,573	4,949	5,325	5,702	6,078	6,454	6,830	7,206	4,299	4,678	5,050

OPTIONS

Wood Species	Arm Caps	Finish	Fabric 1
Selection Required	Standard X9 No Arm Cap	Selection Required	Selection Required
A8S European Beech A8T American Ash	A3 Wood (specify finish) Poly \$109 pair DIN Black DIM Taupe DIP Grey Solid Surface \$624 pair CWS Cameo White MWS Modern White CSS Concrete DMS Deep Mink	See page 9 for full list of finish options	Fabric: Grade, Vendor, Pattern, Color NOTE: For multiple fabric applications see page 14 for information and pricing

HOW TO ORDER

SPECIFY: Wood species | arm caps | wood finish | textile pattern and color. See pages 5-14 for information and options on moisture barrier, CAL133, upholstery applications, a complete offering of finishes and ordering details.

MODEL NUMBER

310-1

Wood Species	Arm Caps	Finish	Fabric 1
A8S	A3	MHM	Grade 5, Momentum, Row, Breeze

MODERN AMENITY LOW BACK, OPEN ARM LOUNGE STANDARD FEATURES

- Upholstered Seat and Back
- Open Arm Frame with Wood Arm Cap is Standard
- Spring Seat Construction
- Tight Cushion
- Specify European Beech or American Ash Exposed Wood
- Tall Wall-Saver Design
- Non-Marring Adjustable Glides
- Field Replaceable Components
- Clean-Thru Design
- NOTE: Because of the unique Color of Ash Hardwoods, Stains are a slightly different Color than they appear on the Standard European Beech Hardwoods. If pairing with a Product using Species other than Ash the Stains will appear different. For additional information please contact your Customer Service Representative.

LOW BACK, OPEN ARM LOUNGE CHAIR

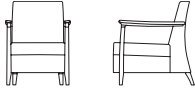

w	outside			sw	seat			seat to top of back	arm height	weight lbs.	cubic feet
	d	h			sd	sh					
27	33	34		21.5	22	17	17	25.25	49	27	

model	yds com (54")	sq ft col	com 1	col 2	3	4	5	6	7	8	9	10	11	12	13	14	15	L1	L2	L3
3100A-1	3	n/a	1,745	1,794	1,851	1,921	2,020	2,161	2,302	2,443	2,584	2,725	2,867	3,008	3,149	3,290	3,431	2,358	2,500	2,640

LOW BACK, OPEN ARM LOVESEAT

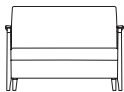

w	outside			sw	seat			seat to top of back	arm height	weight lbs.	cubic feet
	d	h			sd	sh					
47.5	33	34		42	22	17	17	25.25	79	40	

model	yds com (54")	sq ft col	com 1	col 2	3	4	5	6	7	8	9	10	11	12	13	14	15	L1	L2	L3
3100A-2	4.25	n/a	2,243	2,313	2,393	2,493	2,633	2,833	3,032	3,232	3,432	3,632	3,832	4,032	4,231	4,431	4,631	3,100	3,301	3,499

LOW BACK, OPEN ARM SOFA

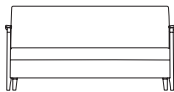

w	outside			sw	seat			seat to top of back	arm height	weight lbs.	cubic feet
	d	h			sd	sh					
68	33	34		62.5	22	17	17	25.25	111	48	

model	yds com (54")	sq ft col	com 1	col 2	3	4	5	6	7	8	9	10	11	12	13	14	15	L1	L2	L3
3100A-3	6.5	n/a	2,681	2,788	2,910	3,063	3,277	3,583	3,888	4,194	4,500	4,805	5,111	5,417	5,722	6,028	6,334	3,976	4,284	4,587

OPTIONS

Wood Species	Arm Caps	Finish	Fabric 1
Selection Required	Standard	Selection Required	Selection Required
A8S European Beech A8T American Ash	A3 Wood (specify finish) Poly \$109 pair DIN Black DIM Taupe DIP Grey Solid Surface \$624 pair CWS Cameo White MWS Modern White CSS Concrete DMS Deep Mink	See page 9 for full list of finish options	Fabric: Grade, Vendor, Pattern, Color NOTE: For multiple fabric applications see page 14 for information and pricing

HOW TO ORDER

SPECIFY: Wood species | arm caps | wood finish | textile pattern and color. See pages 5-14 for information and options on moisture barrier, CAL133, upholstery applications, a complete offering of finishes and ordering details.

MODEL NUMBER

3100A-1

Wood Species	Arm Caps	Finish	Fabric 1
A8S	A3	MHM	Grade 5, Momentum, Row, Breeze

MODERN AMENITY HIGH BACK, UPHOLSTERED ARM LOUNGE STANDARD FEATURES

- Upholstered Arms, Seat and Back
- Upholstered Arm without Arm Cap is Standard
- Spring Seat Construction
- Tight Cushion
- Specify European Beech or American Ash Exposed Wood
- Tall Wall-Saver Design
- Non-Marring Adjustable Glides
- Field Replaceable Components
- Clean-Thru Design
- NOTE: Because of the unique Color of Ash Hardwoods, Stains are a slightly different Color than they appear on the Standard European Beech Hardwoods. If pairing with a Product using Species other than Ash the Stains will appear different. For additional information please contact your Customer Service Representative.

HIGH BACK, UPHOLSTERED ARM LOUNGE CHAIR

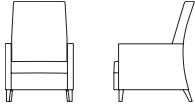

w	outside			sw	seat			seat to top of back	arm height	weight lbs.	cubic feet
	d	h			sd	sh					
29	33	43		24	22	17	26	25.25	68	28	

model	yds com (54")	sq ft col	com 1	col 2	3	4	5	6	7	8	9	10	11	12	13	14	15	L1	L2	L3
311-1	4.75	n/a	1,883	1,961	2,051	2,162	2,319	2,542	2,765	2,989	3,212	3,435	3,659	3,882	4,105	4,329	4,552	2,837	3,062	3,283

HIGH BACK, UPHOLSTERED ARM LOVESEAT

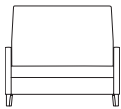

w	outside			sw	seat			seat to top of back	arm height	weight lbs.	cubic feet
	d	h			sd	sh					
50	33	43		44.5	22	17	26	25.25	98	46	

model	yds com (54")	sq ft col	com 1	col 2	3	4	5	6	7	8	9	10	11	12	13	14	15	L1	L2	L3
311-2	6.5	n/a	2,488	2,595	2,717	2,870	3,084	3,390	3,695	4,001	4,307	4,612	4,918	5,224	5,529	5,835	6,141	3,783	4,091	4,394

HIGH BACK, UPHOLSTERED ARM SOFA

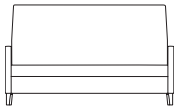

w	outside			sw	seat			seat to top of back	arm height	weight lbs.	cubic feet
	d	h			sd	sh					
70	33	43		65	22	17	26	25.25	130	65	

model	yds com (54")	sq ft col	com 1	col 2	3	4	5	6	7	8	9	10	11	12	13	14	15	L1	L2	L3
311-3	8.25	n/a	3,015	3,151	3,306	3,500	3,771	4,159	4,547	4,935	5,323	5,711	6,099	6,487	6,875	7,263	7,651	4,651	5,042	5,427

OPTIONS

Wood Species	Arm Caps	Finish	Fabric 1
Selection Required	Standard X9 No Arm Cap	Selection Required	Selection Required
A8S European Beech A8T American Ash	A3 Wood (specify finish) Poly \$109 pair DIN Black DIM Taupe DIP Grey Solid Surface \$624 pair CWS Cameo White MWS Modern White CSS Concrete DMS Deep Mink	See page 9 for full list of finish options	Fabric: Grade, Vendor, Pattern, Color NOTE: For multiple fabric applications see page 14 for information and pricing

HOW TO ORDER

SPECIFY: Wood species | arm caps | wood finish | textile pattern and color. See pages 5-14 for information and options on moisture barrier, CAL133, upholstery applications, a complete offering of finishes and ordering details.

MODEL NUMBER

311-1

Wood Species	Arm Caps	Finish	Fabric 1
A8S	A3	MHM	Grade 5, Momentum, Row, Breeze

MODERN AMENITY HIGH BACK, OPEN ARM LOUNGE STANDARD FEATURES

- Upholstered Seat and Back
- Open Arm Frame with Standard Wood Arm Cap
- Spring Seat Construction
- Tight Cushion
- Specify European Beech or American Ash Exposed Wood
- Tall Wall-Saver Design
- Non-Marring Adjustable Glides
- Field Replaceable Components
- Clean-Thru Design
- NOTE: Because of the unique Color of Ash Hardwoods, Stains are a slightly different Color than they appear on the Standard European Beech Hardwoods. If pairing with a Product using Species other than Ash the Stains will appear different. For additional information please contact your Customer Service Representative.

HIGH BACK, OPEN ARM LOUNGE CHAIR

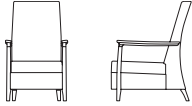

w	outside			sw	seat			seat to top of back	arm height	weight lbs.	cubic feet
	d	h			sd	sh					
27	33	43		21.5	22	17		26	25.25	55	28

model	yds com (54")	sq ft col	com 1	col 2	3	4	5	6	7	8	9	10	11	12	13	14	15	L1	L2	L3
3110A-1	3.25	n/a	1,845	1,898	1,960	2,036	2,143	2,296	2,449	2,601	2,754	2,907	3,060	3,213	3,366	3,518	3,671	2,507	2,661	2,812

HIGH BACK, OPEN ARM LOVESEAT



w	outside			sw	seat			seat to top of back	arm height	weight lbs.	cubic feet
	d	h			sd	sh					
47.5	33	43		42	22	17		26	25.25	85	46

model	yds com (54")	sq ft col	com 1	col 2	3	4	5	6	7	8	9	10	11	12	13	14	15	L1	L2	L3
3110A-2	4.75	n/a	2,426	2,504	2,594	2,705	2,862	3,085	3,308	3,532	3,755	3,978	4,202	4,425	4,648	4,872	5,095	3,380	3,605	3,826

HIGH BACK, OPEN ARM SOFA

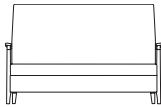

w	outside			sw	seat			seat to top of back	arm height	weight lbs.	cubic feet
	d	h			sd	sh					
68	33	43		62.5	22	17		26	25.25	117	65

model	yds com (54")	sq ft col	com 1	col 2	3	4	5	6	7	8	9	10	11	12	13	14	15	L1	L2	L3
3110A-3	6.5	n/a	2,969	3,076	3,198	3,351	3,565	3,871	4,176	4,482	4,788	5,093	5,399	5,705	6,010	6,316	6,622	4,264	4,572	4,875

OPTIONS

Wood Species	Arm Caps	Finish	Fabric 1
Selection Required	Standard A3 Wood (specify finish)	Selection Required	Selection Required
A8S European Beech A8T American Ash	Poly \$109 pair DIN Black DIM Taupe DIP Grey Solid Surface \$624 pair CWS Cameo White MWS Modern White CSS Concrete DMS Deep Mink	See page 9 for full list of finish options	Fabric: Grade, Vendor, Pattern, Color NOTE: For multiple fabric applications see page 14 for information and pricing

HOW TO ORDER

SPECIFY: Wood species | arm caps | wood finish | textile pattern and color. See pages 5-14 for information and options on moisture barrier, CAL133, upholstery applications, a complete offering of finishes and ordering details.

MODEL NUMBER

3110A-1

Wood Species	Arm Caps	Finish	Fabric 1
A8S	A3	MHM	Grade 5, Momentum, Row, Breeze

ORCHESTRA LOUNGE STANDARD FEATURES

- Clean-Thru Design
- Upholstered Arms, Seat and Back
- Tight Cushion
- Wall-Saver Design
- Removable European Beech Curved and Tapered Legs
- Non-Marring Adjustable Glides

CHAIR

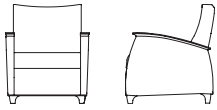

w	outside d	h	sw	seat sd	sh	seat to top of back	arm height	weight lbs.	cubic feet
29.5	32	38	23	19	19.5	n/a	25	65	27

model	yds com (54")	sq ft col	com 1	col 2	3	4	5	6	7	8	9	10	11	12	13	14	15	L1	L2	L3
418-1	5	n/a	1,838	1,920	2,014	2,132	2,296	2,532	2,767	3,002	3,237	3,472	3,707	3,942	4,177	4,413	4,648	2,841	3,078	3,311

LOVESEAT

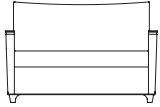

w	outside d	h	sw	seat sd	sh	seat to top of back	arm height	weight lbs.	cubic feet
53.5	32	38	47	19	19.5	n/a	25	95	44

model	yds com (54")	sq ft col	com 1	col 2	3	4	5	6	7	8	9	10	11	12	13	14	15	L1	L2	L3
418-2	7	n/a	2,506	2,621	2,753	2,917	3,148	3,477	3,806	4,135	4,465	4,794	5,123	5,452	5,781	6,110	6,439	3,899	4,231	4,556

SOFA

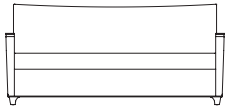

w	outside d	h	sw	seat sd	sh	seat to top of back	arm height	weight lbs.	cubic feet
77.5	32	38	47	19	19.5	n/a	25	125	77

model	yds com (54")	sq ft col	com 1	col 2	3	4	5	6	7	8	9	10	11	12	13	14	15	L1	L2	L3
418-3	9	n/a	3,325	3,473	3,642	3,854	4,150	4,573	4,997	5,420	5,843	6,266	6,690	7,113	7,536	7,959	8,382	5,108	5,534	5,953

OPTIONS

Arm Caps	Finish	Fabric 1
Standard X9 No Arm Cap	Selection Required	Selection Required
A3 Wood (specify finish) \$247 pair A4 Poly (Black) \$185 pair	See page 9 for full list of finish options	Fabric: Grade, Vendor, Pattern, Color NOTE: For multiple fabric applications see page 14 for information and pricing

HOW TO ORDER

SPECIFY: Arm caps | wood finish | textile pattern and color. See pages 5-14 for information and options on moisture barrier, CAL133, upholstery applications, a complete offering of finishes and ordering details.

MODEL NUMBER

418-1

Arm Caps	Finish	Fabric 1
A3	MLC	Grade 5, Momentum, Row, Breeze

REIN+ STANDARD FEATURES

- Rated to 500 lbs.
- Solid Hardwood Frame
- Mortise-and-Tenon Construction
- Clean-Thru Design

- Field Replaceable Components
- Wall-Saver Design
- Non-Marring Adjustable Glides

- Power Supply:
- Available in Black, White or Silver
 - One Power and Two Charging USB
 - 10' Power Cord

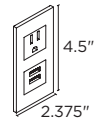

LOUNGE CHAIR

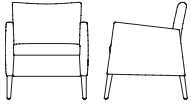

w	outside d	h	sw	seat sd	sh	seat to top of back	arm height	weight lbs.	cubic feet
26	27	31.5	22	20.25	16.5	15	24.5	56	18

model	yds com (54")	sq ft col	com 1	col 2	3	4	5	6	7	8	9	10	11	12	13	14	15	L1	L2	L3
810-1	3.25	n/a	1,161	1,214	1,276	1,352	1,459	1,612	1,765	1,917	2,070	2,223	2,376	2,529	2,682	2,834	2,987	1,823	1,977	2,128

SETTEE

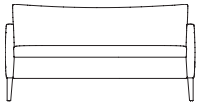

w	outside d	h	sw	seat sd	sh	seat to top of back	arm height	weight lbs.	cubic feet
59	27	31.5	55	20.25	16.5	15	24.5	80	40

model	yds com (54")	sq ft col	com 1	col 2	3	4	5	6	7	8	9	10	11	12	13	14	15	L1	L2	L3
810-3	5.25	n/a	1,842	1,928	2,027	2,151	2,323	2,570	2,817	3,064	3,311	3,558	3,805	4,052	4,298	4,545	4,792	2,894	3,142	3,387

OPTIONS

Arm Caps	Finish	Power Supply	Power Location	Fabric 1
Standard X9 No Arm Cap	Selection Required	Standard X9 No Selection of Option	Standard X9 No Selection of Option	Selection Required
A3 Wood (specify finish) \$84 pair Resin \$71 pair DIN Black DIM Taupe DIP Grey Solid Surface \$232 pair CWS Cameo White MWS Modern White CSS Concrete DMS Deep Mink	See page 9 for full list of finish options	WHT White \$405 BLK Black \$405 SLV Silver \$405	B6G Left Side Facing Arm B6H Right Side Facing Arm	Fabric: Grade, Vendor, Pattern, Color NOTE: For multiple fabric applications see page 14 for information and pricing

HOW TO ORDER

SPECIFY: Arm finish | wood finish | power supply | power location | textile pattern and color. See pages 5-14 for information and options on moisture barrier, CAL133, upholstery applications, a complete offering of finishes and ordering details.

MODEL NUMBER

810-1

Arm Caps	Finish	Power Supply	Power Location	Fabric 1
GLW	MBM	WHT	B6G	Grade 5, Momentum, Row, Breeze

REIN+ STANDARD FEATURES

- Rated to 500 lbs.
- Solid Hardwood Frame
- Mortise-and-Tenon Construction
- Clean-Thru Design
- Field Replaceable Components
- Wall-Saver Design
- Non-Marring Adjustable Glides

- Power Supply:**
- Available in Black, White or Silver
 - One Power and Two Charging USB
 - 10' Power Cord

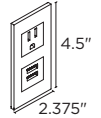

OPEN ARM LOUNGE CHAIR

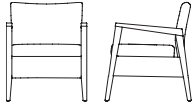

w	outside d	h	sw	seat sd	sh	seat to top of back	arm height	weight lbs.	cubic feet
25.25	27	31.5	22	20.25	16.5	15	24.5	48	18

model	yds com (54")	sq ft col	com 1	col 2	3	4	5	6	7	8	9	10	11	12	13	14	15	L1	L2	L3
811-1	2.5	n/a	963	1,004	1,051	1,110	1,192	1,310	1,427	1,545	1,662	1,780	1,898	2,015	2,133	2,250	2,368	1,478	1,597	1,713

OPEN ARM SETTEE

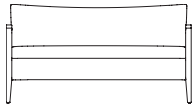

w	outside d	h	sw	seat sd	sh	seat to top of back	arm height	weight lbs.	cubic feet
58.25	27	31.5	55	20.25	16.5	15	24.5	72	40

model	yds com (54")	sq ft col	com 1	col 2	3	4	5	6	7	8	9	10	11	12	13	14	15	L1	L2	L3
811-3	5.25	n/a	1,751	1,837	1,936	2,060	2,232	2,479	2,726	2,973	3,220	3,467	3,714	3,961	4,207	4,454	4,701	2,803	3,051	3,296

OPTIONS

Arm Caps	Finish	Power Supply	Power Location	Fabric 1
Standard X9 No Arm Cap	Selection Required	Standard X9 No Selection of Option	Standard X9 No Selection of Option	Selection Required
Resin \$71 pair DIN Black DIM Taupe DIP Grey	See page 9 for full list of finish options	WHT White \$405 BLK Black \$405 SLV Silver \$405	B6G Left Side Facing Arm B6H Right Side Facing Arm	Fabric: Grade, Vendor, Pattern, Color NOTE: For multiple fabric applications see page 14 for information and pricing
Solid Surface \$232 pair CWS Cameo White MWS Modern White CSS Concrete DMS Deep Mink				

HOW TO ORDER

SPECIFY: Arm caps | wood finish | power supply | power location | textile pattern and color. See pages 5-14 for information and options on moisture barrier, CAL133, upholstery applications, a complete offering of finishes and ordering details.

MODEL NUMBER

811-1

Arm Caps	Finish	Power Supply	Power Location	Fabric 1
GLW	MBM	WHT	B6G	Grade 5, Momentum, Row, Breeze

REIN+ STANDARD FEATURES

- Rated to 500 lbs.
- Solid Hardwood Frame
- Mortise-and-Tenon Construction
- Clean-Thru Design
- Field Replaceable Components
- Wall-Saver Design
- Non-Marring Adjustable Glides

- Power Supply:
- Available in Black, White or Silver
 - One Power and Two Charging USB
 - 6' Power Cord

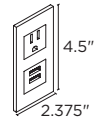

BENCH

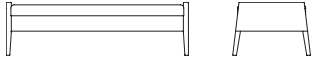

w	outside d	h	sw	seat sd	sh	seat to top of back	arm height	weight lbs.	cubic feet
59	24.75	17.5	55	21.75	16.5	n/a	17.5	73	26

model	yds com (54")	sq ft col	com 1	col 2	3	4	5	6	7	8	9	10	11	12	13	14	15	L1	L2	L3
810-B	3	n/a	1,252	1,301	1,358	1,428	1,527	1,668	1,809	1,950	2,091	2,232	2,374	2,515	2,656	2,797	2,938	1,865	2,007	2,147

OPEN ARM BENCH

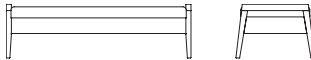

w	outside d	h	sw	seat sd	sh	seat to top of back	arm height	weight lbs.	cubic feet
58.25	24.75	17.5	55	21.75	16.5	n/a	17.5	45	26

model	yds com (54")	sq ft col	com 1	col 2	3	4	5	6	7	8	9	10	11	12	13	14	15	L1	L2	L3
811-B	1.75	n/a	1,326	1,355	1,388	1,429	1,486	1,569	1,651	1,733	1,816	1,898	1,980	2,063	2,145	2,227	2,309	1,695	1,778	1,860

OPTIONS

Arm Caps	Finish	Power Supply	Power Location	Fabric 1
Standard X9 No Arm Cap	Selection Required	Standard X9 No Selection of Option	Standard X9 No Selection of Option	Selection Required
A3 Wood (810 only) (specify finish) \$84 pair Resin \$71 pair DIN Black DIM Taupe DIP Grey Solid Surface \$232 pair CWS Cameo White MWS Modern White CSS Concrete DMS Deep Mink	See page 9 for full list of finish options	WHT White \$405 BLK Black \$405 SLV Silver \$405	B6G Left Side Facing Arm B6H Right Side Facing Arm	Fabric: Grade, Vendor, Pattern, Color NOTE: For multiple fabric applications see page 14 for information and pricing

HOW TO ORDER

SPECIFY: Arm caps | wood finish | power supply | power location | textile pattern and color. See pages 5-14 for information and options on moisture barrier, CAL133, upholstery applications, a complete offering of finishes and ordering details.

MODEL NUMBER

810-B

Arm Caps	Finish	Power Supply	Power Location	Fabric 1
GLW	MBM	WHT	B6G	Grade 5, Momentum, Row, Breeze

RETROSPECT ARMLESS LOUNGE STANDARD FEATURES

- Armless
- Upholstered Seat and Back
- Tight Cushion
- 7" Machine Turned Satin Aluminum Legs
- Non-Marring Adjustable Glides
- E7 and E8 Casters:**
 - Caster Legs are Machine Turned Satin Aluminum with Anodized Finish and Black Rotating Dual Wheel

ARMLESS CHAIR

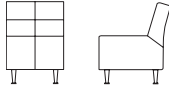

w	outside d	h	sw	seat sd	sh	seat to top of back	arm height	weight lbs.	cubic feet
24	29	34	24	20	19	16	n/a	60	19

model	yds com (54")	sq ft col	com 1	col 2	3	4	5	6	7	8	9	10	11	12	13	14	15	L1	L2	L3
7010-SB-SK2	3	n/a	1,371	1,420	1,477	1,547	1,646	1,787	1,928	2,069	2,210	2,351	2,493	2,634	2,775	2,916	3,057	1,984	2,126	2,266

ARMLESS LOVESEAT

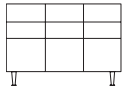

w	outside d	h	sw	seat sd	sh	seat to top of back	arm height	weight lbs.	cubic feet
48	29	34	48	20	19	16	n/a	90	33

model	yds com (54")	sq ft col	com 1	col 2	3	4	5	6	7	8	9	10	11	12	13	14	15	L1	L2	L3
7010-LB-LK2	4.75	n/a	1,955	2,033	2,123	2,234	2,391	2,614	2,837	3,061	3,284	3,507	3,731	3,954	4,177	4,401	4,624	2,909	3,134	3,355

ARMLESS SOFA

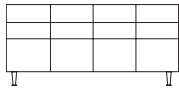

w	outside d	h	sw	seat sd	sh	seat to top of back	arm height	weight lbs.	cubic feet
72	29	34	72	20	19	16	n/a	120	48

model	yds com (54")	sq ft col	com 1	col 2	3	4	5	6	7	8	9	10	11	12	13	14	15	L1	L2	L3
7010-FB-FK2	6	n/a	2,653	2,752	2,865	3,006	3,203	3,485	3,767	4,050	4,332	4,614	4,896	5,178	5,460	5,742	6,025	3,851	4,135	4,414

OPTIONS

Leg and Caster	Fabric 1
Standard X9 Satin Aluminum Legs	Selection Required
DIT Four Wood Legs (specify finish) \$122 E7 Caster Legs (set of 4) \$122 E8 Caster Legs (set of 2) and two standard legs \$61	Fabric: Grade, Vendor, Pattern, Color NOTE: For multiple fabric applications see page 14 for information and pricing

HOW TO ORDER

SPECIFY: Leg and caster | leg finish (if applicable) | textile pattern and color. See **pages 5-14** for information and options on moisture barrier, CAL133, upholstery applications, a complete offering of finishes and ordering details.

MODEL NUMBER	
7010-SB-SK2	
Leg and Caster	Fabric 1
DIT - MLC	Grade 5, Momentum, Row, Breeze

RETROSPECT FLARED ARM LOUNGE STANDARD FEATURES

- Upholstered Flared Arm
- Upholstered Seat and Back
- Tight Cushion
- 7" Machine Turned Satin Aluminum Legs
- Bolster Pillows are Attached with D-Ring and Elastic Straps
- Non-Marring Adjustable Glides
- E7 and E8 Casters:**
- Caster Legs are Machine Turned Satin Aluminum with Anodized Finish and Black Rotating Dual Wheel

FLARED ARM CHAIR

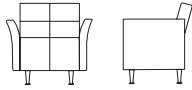

w	outside d	h	sw	seat sd	sh	seat to top of back	arm height	weight lbs.	cubic feet
34	29	34	24	20	19	16	26.5	65	27

model	yds com (54")	sq ft col	com 1	col 2	3	4	5	6	7	8	9	10	11	12	13	14	15	L1	L2	L3
7010-SB-SK2-C1D	5	n/a	1,629	1,711	1,805	1,923	2,087	2,323	2,558	2,793	3,028	3,263	3,498	3,733	3,968	4,204	4,439	2,632	2,869	3,102

FLARED ARM LOVESEAT WITH BOLSTERS

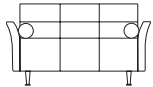

w	outside d	h	sw	seat sd	sh	seat to top of back	arm height	weight lbs.	cubic feet
58	29	34	48	20	19	16	26.5	95	44

model	yds com (54")	sq ft col	com 1	col 2	3	4	5	6	7	8	9	10	11	12	13	14	15	L1	L2	L3
7010-LB-LK2-C1D-C1C	7.75	n/a	2,565	2,693	2,838	3,021	3,276	3,640	4,004	4,369	4,733	5,098	5,462	5,827	6,191	6,556	6,920	4,104	4,471	4,832

FLARED ARM SOFA WITH BOLSTERS

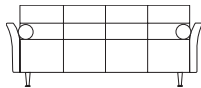

w	outside d	h	sw	seat sd	sh	seat to top of back	arm height	weight lbs.	cubic feet
82	29	34	72	20	19	16	26.5	125	66

model	yds com (54")	sq ft col	com 1	col 2	3	4	5	6	7	8	9	10	11	12	13	14	15	L1	L2	L3
7010-FB-FK2-C1D-C1C	9	n/a	3,263	3,411	3,580	3,792	4,088	4,511	4,935	5,358	5,781	6,204	6,628	7,051	7,474	7,897	8,320	5,046	5,472	5,891

OPTIONS

Leg and Caster	Fabric 1	Fabric 2 for Bolsters
Standard X9 Satin Aluminum Legs	Selection Required	Selection Required
DIT Four Wood Legs (specify finish) \$122 E7 Caster Legs (set of 4) \$122 E8 Caster Legs (set of 2) and two standard legs \$61	Fabric: Grade, Vendor, Pattern, Color NOTE: For multiple fabric applications see page 14 for information and pricing	Fabric: Grade, Vendor, Pattern, Color NOTE: For multiple fabric applications see page 14 for information and pricing

HOW TO ORDER

SPECIFY: Leg and caster | leg finish (if applicable) | textile 1 pattern and color | textile 2 pattern and color for bolsters. See pages 5-14 for information and options on moisture barrier, CAL133, upholstery applications, a complete offering of finishes and ordering details.

MODEL NUMBER

7010-SB-SK2-C1D

Leg and Caster	Fabric 1	Fabric 2 for Bolsters
DIT - MLC	Grade 5, Momentum, Row, Breeze	Grade 5, Momentum, Row, Breeze

RETROSPECT STRAIGHT ARM LOUNGE STANDARD FEATURES

- Upholstered Straight Arm
- Upholstered Seat and Back
- Tight Cushion
- 7" Machine Turned Satin Aluminum Legs
- Bolster Pillows are Attached with D-Ring and Elastic Straps
- Non-Marring Adjustable Glides
- E7 and E8 Casters:**
- Caster Legs are Machine Turned Satin Aluminum with Anodized Finish and Black Rotating Dual Wheel

STRAIGHT ARM CHAIR

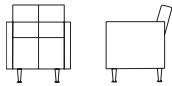

w	outside d	h	sw	seat sd	sh	seat to top of back	arm height	weight lbs.	cubic feet
28	29	34	24	20	19	16	26.5	65	27

model	yds com (54")	sq ft col	com 1	col 2	3	4	5	6	7	8	9	10	11	12	13	14	15	L1	L2	L3
7010-SB-SK2-C1E	5	n/a	1,629	1,711	1,805	1,923	2,087	2,323	2,558	2,793	3,028	3,263	3,498	3,733	3,968	4,204	4,439	2,632	2,869	3,102

STRAIGHT ARM LOVESEAT WITH BOLSTERS

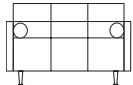

w	outside d	h	sw	seat sd	sh	seat to top of back	arm height	weight lbs.	cubic feet
52	29	34	48	20	19	16	26.5	95	44

model	yds com (54")	sq ft col	com 1	col 2	3	4	5	6	7	8	9	10	11	12	13	14	15	L1	L2	L3
7010-LB-LK2-C1E-C1C	7.75	n/a	2,565	2,693	2,838	3,021	3,276	3,640	4,004	4,369	4,733	5,098	5,462	5,827	6,191	6,556	6,920	4,104	4,471	4,832

STRAIGHT ARM SOFA WITH BOLSTERS

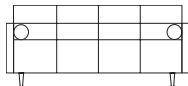

w	outside d	h	sw	seat sd	sh	seat to top of back	arm height	weight lbs.	cubic feet
76	29	34	72	20	19	16	26.5	125	66

model	yds com (54")	sq ft col	com 1	col 2	3	4	5	6	7	8	9	10	11	12	13	14	15	L1	L2	L3
7010-FB-FK2-C1E-C1C	9	n/a	3,263	3,411	3,580	3,792	4,088	4,511	4,935	5,358	5,781	6,204	6,628	7,051	7,474	7,897	8,320	5,046	5,472	5,891

OPTIONS

Leg and Caster	Fabric 1	Fabric 2 for Bolsters
Standard X9 Satin Aluminum Legs	Selection Required	Selection Required
DIT Four Wood Legs (specify finish) \$122 E7 Caster Legs (set of 4) \$122 E8 Caster Legs (set of 2) and two standard legs \$61	Fabric: Grade, Vendor, Pattern, Color NOTE: For multiple fabric applications see page 14 for information and pricing	Fabric: Grade, Vendor, Pattern, Color NOTE: For multiple fabric applications see page 14 for information and pricing

HOW TO ORDER

SPECIFY: Leg and caster | leg finish (if applicable) | textile 1 pattern and color | textile 2 pattern and color for bolsters. See pages 5-14 for information and options on moisture barrier, CAL133, upholstery applications, a complete offering of finishes and ordering details.

MODEL NUMBER

7010-SB-SK2-C1E

Leg and Caster	Fabric 1	Fabric 2 for Bolsters
DIT - MLC	Grade 5, Momentum, Row, Breeze	Grade 5, Momentum, Row, Breeze

RETROSPECT BENCH STANDARD FEATURES

- Armless
- Upholstered Seat
- 7" Machine Turned Satin Aluminum Legs
- Non-Marring Adjustable Glides
- E7 and E8 Casters:**
 - Caster Legs are Machine Turned Satin Aluminum with Anodized Finish and Black Rotating Dual Wheel

BENCH

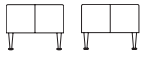

		model																	w	d	h	wt	cu ft
		7010-SB																	24	24	19	20	13
yds com (54")	sq ft col	com 1	col 2	3	4	5	6	7	8	9	10	11	12	13	14	15	L1	L2	L3				
1.5	n/a	882	907	935	970	1,020	1,090	1,161	1,231	1,302	1,372	1,443	1,513	1,584	1,654	1,725	1,202	1,274	1,343				

BENCH

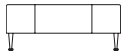

		model																	w	d	h	wt	cu ft
		7010-LB																	48	24	19	40	22
yds com (54")	sq ft col	com 1	col 2	3	4	5	6	7	8	9	10	11	12	13	14	15	L1	L2	L3				
2.25	n/a	1,220	1,257	1,299	1,352	1,426	1,532	1,638	1,744	1,850	1,955	2,061	2,167	2,273	2,379	2,484	1,687	1,793	1,898				

BENCH

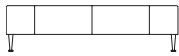

		model																	w	d	h	wt	cu ft
		7010-FB																	72	24	19	60	31
yds com (54")	sq ft col	com 1	col 2	3	4	5	6	7	8	9	10	11	12	13	14	15	L1	L2	L3				
3	n/a	1,577	1,626	1,683	1,753	1,852	1,993	2,134	2,275	2,416	2,557	2,699	2,840	2,981	3,122	3,263	2,190	2,332	2,472				

OPTIONS

Leg and Caster	Fabric 1
Standard X9 Satin Aluminum Legs	Selection Required
DIT Four Wood Legs (specify finish) \$122 E7 Caster Legs (set of 4) \$122 E8 Caster Legs (set of 2) and two standard legs \$61	Fabric: Grade, Vendor, Pattern, Color NOTE: For multiple fabric applications see page 14 for information and pricing

HOW TO ORDER

SPECIFY: Leg and caster | leg finish (if applicable) | textile pattern and color. See **pages 5-14** for information and options on moisture barrier, CAL133, upholstery applications, a complete offering of finishes and ordering details.

MODEL NUMBER

7010-SB

Leg and Caster	Fabric 1
DIT - MLC	Grade 5, Momentum, Row, Breeze

RETROSPECT CHILDREN'S BENCH STANDARD FEATURES

- Armless
- Upholstered Seat
- 3.5" Machine Turned Satin Aluminum Legs
- Non-Marring Adjustable Glides

BENCH



model	w	d	h	wt	cu ft
7010-SBC	24	16	15.5	15	10

yds com (54")	sq ft col	com 1	col 2	3	4	5	6	7	8	9	10	11	12	13	14	15	L1	L2	L3
1.5	n/a	740	765	793	828	878	948	1,019	1,089	1,160	1,230	1,301	1,371	1,442	1,512	1,583	1,060	1,132	1,201

BENCH

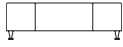

model	w	d	h	wt	cu ft
7010-LBC	48	16	15.5	35	20

yds com (54")	sq ft col	com 1	col 2	3	4	5	6	7	8	9	10	11	12	13	14	15	L1	L2	L3
2	n/a	1,031	1,064	1,102	1,149	1,214	1,308	1,402	1,497	1,591	1,685	1,779	1,873	1,967	2,061	2,155	1,449	1,544	1,637

BENCH

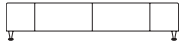

model	w	d	h	wt	cu ft
7010-FBC	72	16	15.5	55	30

yds com (54")	sq ft col	com 1	col 2	3	4	5	6	7	8	9	10	11	12	13	14	15	L1	L2	L3
2.75	n/a	1,280	1,325	1,377	1,442	1,532	1,661	1,791	1,920	2,049	2,179	2,308	2,437	2,567	2,696	2,825	1,844	1,975	2,103

OPTIONS

Legs	Fabric 1
Standard X9 Satin Aluminum Legs	Selection Required
DIT Four Wood Legs (specify finish) \$122	Fabric: Grade, Vendor, Pattern, Color NOTE: For multiple fabric applications see page 14 for information and pricing

HOW TO ORDER

SPECIFY: Legs | leg finish (if applicable) | textile pattern and color. See pages 5-14 for information and options on moisture barrier, CAL133, upholstery applications, a complete offering of finishes and ordering details.

MODEL NUMBER

7010-SBC

Legs	Fabric 1
DIT - MLC	Grade 5, Momentum, Row, Breeze

RULE OF THREE ARMLESS LOUNGE STANDARD FEATURES

- Armless
- Upholstered Seat and Back
- Spring Seat Construction
- Clean-Thru Design (Available on Chair and Settee)
- Wall-Saver Design (Available on Chair and Settee)
- Tight Cushion
- 3/4" Tubular Bent Luster Grey Powder Coated Metal Frame inset into Upholstered End Panel
- White Plastic Glide fitted into the Bottom of Tubular Leg

ARMLESS CHAIR



w	outside d	h	sw	seat sd	sh	seat to top of back	arm height	weight lbs.	cubic feet
25.75	27	32	22	20	18	14	17.5	35	12

model	yds com (54")	sq ft col	com 1	col 2	3	4	5	6	7	8	9	10	11	12	13	14	15	L1	L2	L3
391-1	2.75	n/a	1,224	1,269	1,321	1,386	1,476	1,605	1,735	1,864	1,993	2,123	2,252	2,381	2,511	2,640	2,769	1,788	1,919	2,047

ARMLESS LOVESEAT



w	outside d	h	sw	seat sd	sh	seat to top of back	arm height	weight lbs.	cubic feet
48	27	32	44	20	18	14	17.5	50	24

model	yds com (54")	sq ft col	com 1	col 2	3	4	5	6	7	8	9	10	11	12	13	14	15	L1	L2	L3
391-2	4	n/a	1,714	1,780	1,855	1,949	2,081	2,269	2,457	2,645	2,833	3,021	3,209	3,397	3,586	3,774	3,962	2,522	2,711	2,898

ARMLESS 48" BENCH



w	outside d	h	sw	seat sd	sh	seat to top of back	arm height	weight lbs.	cubic feet
48	24	18.5	44	24	18.5	n/a	17.5	45	12

model	yds com (54")	sq ft col	com 1	col 2	3	4	5	6	7	8	9	10	11	12	13	14	15	L1	L2	L3
391-B48	2.5	n/a	1,268	1,309	1,356	1,415	1,497	1,615	1,732	1,850	1,967	2,085	2,203	2,320	2,438	2,555	2,673	1,783	1,902	2,018

OPTIONS

Powder Coat	Removable Covers	Fabric 1
Standard MSL Luster Grey	Standard X9 No Selection of Option	Selection Required
BWT Bone White BUFF Buff CHLK Chalk SGLD Gold GRPH Graphite MSL Luster Grey HIP Oiled Bronze BKO Onyx POLR Polar SBRZ Soft Bronze HIF Warm Grey	H7 Removable Seat and Back Covers \$196 B1L Removable Seat Cover only \$98 B1M Removable Back Cover only \$98	Fabric: Grade, Vendor, Pattern, Color NOTE: For multiple fabric applications see page 14 for information and pricing

HOW TO ORDER

SPECIFY: Powder coat | removable covers | textile pattern and color. See pages 5-14 for information and options on moisture barrier, CAL133, upholstery applications, a complete offering of finishes and ordering details.

MODEL NUMBER

391-1

Powder Coat	Removable Covers	Fabric 1
MSL	H7	Grade 5, Momentum, Row, Breeze

RULE OF THREE OPEN ARM LOUNGE STANDARD FEATURES

- Upholstered Open Arm Frame
- Upholstered Seat and Back
- Spring Seat Construction
- Clean-Thru Design
- Wall-Saver Design
- Tight Cushion
- 3/4" Tubular Bent Luster Grey Powder Coated Metal Frame inset into Upholstered Arm Frame
- White Plastic Glide fitted into the Bottom of Tubular Leg

OPEN ARM CHAIR

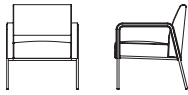

w	outside		h	sw	seat		seat to top of back							arm height	weight lbs.	cubic feet
	d				sd	sh										
25.75	27		32	22	20	18	14							25	35	12

model	yds com (54")	sq ft col	com 1	col 2	3	4	5	6	7	8	9	10	11	12	13	14	15	L1	L2	L3
392-1	3	n/a	1,255	1,304	1,361	1,431	1,530	1,671	1,812	1,953	2,094	2,235	2,377	2,518	2,659	2,800	2,941	1,868	2,010	2,150

OPEN ARM LOVESEAT

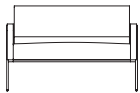

w	outside		h	sw	seat		seat to top of back							arm height	weight lbs.	cubic feet
	d				sd	sh										
48	27		32	44	20	18	14							25	50	24

model	yds com (54")	sq ft col	com 1	col 2	3	4	5	6	7	8	9	10	11	12	13	14	15	L1	L2	L3
392-2	4.25	n/a	1,748	1,818	1,898	1,998	2,138	2,338	2,537	2,737	2,937	3,137	3,337	3,537	3,736	3,936	4,136	2,605	2,806	3,004

OPTIONS

Arm Caps	Powder Coat	Removable Covers	Fabric 1
Standard	Standard	Standard	Selection Required
X9 No Arm Cap	MSL Luster Grey	X9 No Selection of Option	
A4 Resin (Black) \$210 pair	BWT Bone White BUFF Buff CHLK Chalk SGLD Gold GRPH Graphite MSL Luster Grey HIP Oiled Bronze BKO Onyx POLR Polar SBRZ Soft Bronze HIF Warm Grey	H7 Removable Seat and Back Covers \$196 B1L Removable Seat Cover only \$98 B1M Removable Back Cover only \$98	Fabric: Grade, Vendor, Pattern, Color NOTE: For multiple fabric applications see page 14 for information and pricing

HOW TO ORDER

SPECIFY: Arm caps | powder coat | removable covers | textile pattern and color. See pages 5-14 for information and options on moisture barrier, CAL133, upholstery applications, a complete offering of finishes and ordering details.

MODEL NUMBER

392-1

Arm Caps	Powder Coat	Removable Covers	Fabric 1
A4	MSL	H7	Grade 5, Momentum, Row, Breeze

RULE OF THREE PANEL ARM LOUNGE STANDARD FEATURES

- Upholstered Arm Frame fitted with Upholstered Panel
- Upholstered Seat and Back
- Tight Cushion
- Spring Seat Construction
- Clean-Thru Design
- Wall-Saver Design
- 3/4" Tubular Bent Luster Grey Powder Coated Metal Frame inset into Upholstered Arm Frame
- White Plastic Glide fitted into the Bottom of Tubular Leg

PANEL ARM CHAIR



w	outside d	h	sw	seat sd	sh	seat to top of back	arm height	weight lbs.	cubic feet
25.75	27	32	22	20	18	14	25	35	12

model	yds com (54")	sq ft col	com 1	col 2	3	4	5	6	7	8	9	10	11	12	13	14	15	L1	L2	L3
393-1	4.25	n/a	1,450	1,520	1,600	1,700	1,840	2,040	2,239	2,439	2,639	2,839	3,039	3,239	3,438	3,638	3,838	2,307	2,508	2,706

PANEL ARM LOVESEAT

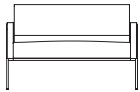

w	outside d	h	sw	seat sd	sh	seat to top of back	arm height	weight lbs.	cubic feet
48	27	32	44	20	18	14	25	50	24

model	yds com (54")	sq ft col	com 1	col 2	3	4	5	6	7	8	9	10	11	12	13	14	15	L1	L2	L3
393-2	5.5	n/a	1,915	2,006	2,109	2,238	2,419	2,678	2,937	3,195	3,454	3,712	3,971	4,230	4,488	4,747	5,006	3,015	3,276	3,532

OPTIONS

Arm Caps	Powder Coat	Removable Covers	Fabric 1
Standard X9 No Arm Cap	Standard MSL Luster Grey	Standard X9 No Selection of Option	Selection Required
A4 Resin (Black) \$210 pair	BWT Bone White BUFF Buff CHLK Chalk SGLD Gold GRPH Graphite MSL Luster Grey HIP Oiled Bronze BKO Onyx POLR Polar SBRZ Soft Bronze HIF Warm Grey	H7 Removable Seat and Back Covers \$196 B1L Removable Seat Cover only \$98 B1M Removable Back Cover only \$98	Fabric: Grade, Vendor, Pattern, Color NOTE: For multiple fabric applications see page 14 for information and pricing

HOW TO ORDER

SPECIFY: Arm caps | powder coat | removable covers | textile pattern and color. See pages 5-14 for information and options on moisture barrier, CAL133, upholstery applications, a complete offering of finishes and ordering details.

MODEL NUMBER

393-1

Arm Caps	Powder Coat	Removable Covers	Fabric 1
A4	MSL	H7	Grade 5, Momentum, Row, Breeze

RULE OF THREE WOOD ARM LOUNGE STANDARD FEATURES

- Wood Open Arm Frame
- Upholstered Seat and Back
- Tight Cushion
- Spring Seat Construction
- Clean-Thru Design
- Wall-Saver Design
- 3/4" Tubular Bent Luster Grey Powder Coated Metal Frame inset into Upholstered Arm Frame
- White Plastic Glide fitted into the Bottom of Tubular Leg

WOOD ARM CHAIR

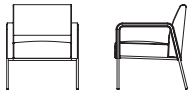

w	outside			sw	seat			seat to top of back	arm height	weight lbs.	cubic feet
	d	h			sd	sh					
25.75	27	32		22	20	18	14	25	35	12	

model	yds com (54")	sq ft col	com 1	col 2	3	4	5	6	7	8	9	10	11	12	13	14	15	L1	L2	L3
394-1	3	n/a	1,471	1,520	1,577	1,647	1,746	1,887	2,028	2,169	2,310	2,451	2,593	2,734	2,875	3,016	3,157	2,084	2,226	2,366

WOOD ARM LOVESEAT

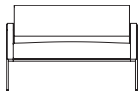

w	outside			sw	seat			seat to top of back	arm height	weight lbs.	cubic feet
	d	h			sd	sh					
48	27	32		44	20	18	14	25	50	24	

model	yds com (54")	sq ft col	com 1	col 2	3	4	5	6	7	8	9	10	11	12	13	14	15	L1	L2	L3
394-2	4.25	n/a	1,803	1,873	1,953	2,053	2,193	2,393	2,592	2,792	2,992	3,192	3,392	3,592	3,791	3,991	4,191	2,660	2,861	3,059

OPTIONS

Arm Caps	Finish	Powder Coat	Removable Covers	Fabric 1
Standard X9 No Arm Cap	Selection Required	Standard MSL Luster Grey	Standard X9 No Selection of Option	Selection Required
A4 Resin (Black) \$210 pair	BWT Bone White BUFF Buff CHLK Chalk SGLD Gold GRPH Graphite MSL Luster Grey HIP Oiled Bronze BKO Onyx POLR Polar SBRZ Soft Bronze HIF Warm Grey	See page 9 for full list of powder coat options	H7 Removable Seat and Back Covers \$196 B1L Removable Seat Cover only \$98 B1M Removable Back Cover only \$98	Fabric: Grade, Vendor, Pattern, Color NOTE: For multiple fabric applications see page 14 for information and pricing

HOW TO ORDER

SPECIFY: Arm caps | arm finish | powder coat | removable covers | textile pattern and color. See pages 5-14 for information and options on moisture barrier, CAL133, upholstery applications, a complete offering of finishes and ordering details.

MODEL NUMBER

394-1

Arm Caps	Finish	Powder Coat	Removable Covers	Fabric 1
A4	MNW	MSL	H7	Grade 5, Momentum, Row, Breeze

SEEK LOUNGE STANDARD FEATURES

- Clean-Thru Design
- Upholstered Arms, Seat and Back
- Tight Cushion
- Tapered European Beech Legs
- Tack-In Non-Marring Glide

CHAIR

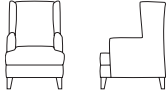

w	outside			sw	seat			seat to top of back							arm height	weight lbs.	cubic feet
	d	h		sd	sh												
29	34	44		22	21	20	27							26	80	29	

model	yds com (54")	sq ft col	com 1	col 2	3	4	5	6	7	8	9	10	11	12	13	14	15	L1	L2	L3
682-1	6.75	n/a	2,169	2,272	2,389	2,536	2,742	3,036	3,330	3,624	3,918	4,212	4,505	4,799	5,093	5,387	5,681	3,416	3,712	4,003

LOVESEAT



w	outside			sw	seat			seat to top of back							arm height	weight lbs.	cubic feet
	d	h		sd	sh												
50	34	44		44	21	20	27							26	120	40	

model	yds com (54")	sq ft col	com 1	col 2	3	4	5	6	7	8	9	10	11	12	13	14	15	L1	L2	L3
682-2	8.25	n/a	2,846	2,982	3,137	3,331	3,602	3,990	4,378	4,766	5,154	5,542	5,930	6,318	6,706	7,094	7,482	4,482	4,873	5,258

OPTIONS

Finish	Fabric 1
Selection Required	Selection Required
See page 9 for full list of finish options	Fabric: Grade, Vendor, Pattern, Color NOTE: For multiple fabric applications see page 14 for information and pricing

HOW TO ORDER

SPECIFY: Wood finish | textile pattern and color. See pages 5-14 for information and options on moisture barrier, CAL133, upholstery applications, a complete offering of finishes and ordering details.

MODEL NUMBER

682-1

Finish	Fabric 1
MLC	Grade 5, Momentum, Row, Breeze

SERONY LOUNGE STANDARD FEATURES

- Upholstered Seat and Back
- Clean-Thru Design
- Wall-Saver Design
- Tight Cushion
- Luster Grey Powder Coat on all Exposed Metal
- Poly Arm Caps (specify color)
- Non-Marring Adjustable Glides

CHAIR

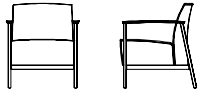

w	outside			sw	seat			seat to top of back	arm height	weight lbs.	cubic feet
	d	h			sd	sh					
27	25.5	31		23	20	18		13	25	48.5	12.5

model	yds com (54")	sq ft col	com 1	col 2	3	4	5	6	7	8	9	10	11	12	13	14	15	L1	L2	L3
472-1	2	n/a	1,377	1,410	1,448	1,495	1,560	1,654	1,748	1,843	1,937	2,031	2,125	2,219	2,313	2,407	2,501	1,795	1,890	1,983

LOVESEAT

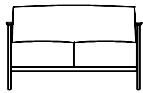

w	outside			sw	seat			seat to top of back	arm height	weight lbs.	cubic feet
	d	h			sd	sh					
49	25.5	31		46	20	18		13	25	81	23

model	yds com (54")	sq ft col	com 1	col 2	3	4	5	6	7	8	9	10	11	12	13	14	15	L1	L2	L3
472-2	3.75	n/a	2,323	2,385	2,455	2,543	2,667	2,843	3,020	3,196	3,372	3,549	3,725	3,901	4,078	4,254	4,430	3,082	3,260	3,434

SOFA

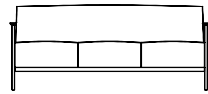

w	outside			sw	seat			seat to top of back	arm height	weight lbs.	cubic feet
	d	h			sd	sh					
73	25.5	31		69	20	18		13	25	113	34

model	yds com (54")	sq ft col	com 1	col 2	3	4	5	6	7	8	9	10	11	12	13	14	15	L1	L2	L3
472-3	5.5	n/a	3,131	3,222	3,325	3,454	3,635	3,894	4,153	4,411	4,670	4,928	5,187	5,446	5,704	5,963	6,222	4,231	4,492	4,748

OPTIONS

Powder Coat	Arm Cap Finish	Fabric 1
Standard MSL Luster Grey	Standard DIN Black Poly	Selection Required
BWT Bone White BUFF Buff CHLK Chalk SGLD Gold GRPH Graphite MSL Luster Grey HIP Oiled Bronze BKO Onyx POLR Polar SBRZ Soft Bronze HIF Warm Grey	DIM Taupe Poly DIP Grey Poly A3 Wood (specify finish) Solid Surface \$530 pair CWS Cameo White MWS Modern White CSS Concrete DMS Deep Mink	Fabric : Grade, Vendor, Pattern, Color NOTE: For multiple fabric applications see page 14 for information and pricing

HOW TO ORDER

SPECIFY: Arm Caps | arm cap finish (if applicable) | powder coat | textile pattern and color. See pages 5-14 for information and options on moisture barrier, CAL133, upholstery applications, a complete offering of finishes and ordering details.

MODEL NUMBER

472-1

Arm Caps	Powder Coat	Fabric 1
DIN	MSL	Grade 5, Momentum, Row, Breeze

SERONY BEHAVIORAL HEALTH LOUNGE STANDARD FEATURES

- Upholstered Seat and Back
- Wall-Saver Design
- Tight Cushion
- Luster Grey Powder Coat on all Exposed Metal
- Black Poly Arm Caps
- Polyurethane coated Steel Foot Rest
- Weighted Units
- Tamper-proof Tooling
- Non-Marring Adjustable Glides

CHAIR

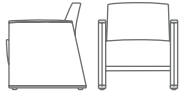

w	outside			sw	seat			seat to top of back	arm height	weight lbs.	cubic feet
	d	h			sd	sh					
28	25.75	31		23	20	18	13	25	85	13	

model	yds com (54")	sq ft col	com 1	col 2	3	4	5	6	7	8	9	10	11	12	13	14	15	L1	L2	L3
471BHU-1	4	n/a	1,800	1,866	1,941	2,035	2,167	2,355	2,543	2,731	2,919	3,107	3,295	3,483	3,672	3,860	4,048	2,608	2,797	2,984

LOVESEAT

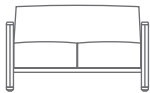

w	outside			sw	seat			seat to top of back	arm height	weight lbs.	cubic feet
	d	h			sd	sh					
51	25.75	31		46	20	18	13	25	117	24	

model	yds com (54")	sq ft col	com 1	col 2	3	4	5	6	7	8	9	10	11	12	13	14	15	L1	L2	L3
471BHU-2	5.75	n/a	2,500	2,595	2,703	2,838	3,027	3,298	3,568	3,838	4,109	4,379	4,650	4,920	5,190	5,461	5,731	3,649	3,922	4,189

SOFA

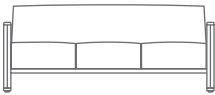

w	outside			sw	seat			seat to top of back	arm height	weight lbs.	cubic feet
	d	h			sd	sh					
74	25.5	31		69	20	18	13	25	150	34	

model	yds com (54")	sq ft col	com 1	col 2	3	4	5	6	7	8	9	10	11	12	13	14	15	L1	L2	L3
471BHU-3	7.5	n/a	3,200	3,323	3,465	3,641	3,888	4,240	4,593	5,946	5,298	5,651	6,004	6,356	6,709	7,062	7,414	4,690	5,046	5,395

Arm Caps	Powder Coat	Foot Rest	Fabric 1
Standard D1N Black	Standard MSL Luster Grey	Standard PAB Black	Selection Required
D1M Taupe Poly D1P Grey Poly A3 Wood (specify finish) Solid Surface \$530 pair CWS Cameo White MWS Modern White CSS Concrete DMS Deep Mink	BWT Bone White BUFF Buff CHLK Chalk SGLD Gold GRPH Graphite MSL Luster Grey HIP Oiled Bronze BKO Onyx POLR Polar SBRZ Soft Bronze HIF Warm Grey	C7V Black C8B Taupe C8A Grey	Fabric : Grade, Vendor, Pattern, Color NOTE: For multiple fabric applications see page 14 for information and pricing

Powder Coat	Powder Coat	Foot Rest	Fabric 1
MSL	MSL	PAB	Grade 5, Momentum, Row, Breeze

SERONY BEHAVIORAL HEALTH LOUNGE STANDARD FEATURES

- Upholstered Seat and Back with 3DL Arms
- Wall-Saver Design
- Tight Cushion
- Luster Grey Powder Coat on all Exposed Metal
- Black Poly Arm Caps
- Polyurethane coated Steel Foot Rest
- Weighted Units
- Tamper-proof Tooling
- Non-Marring Adjustable Glides

CHAIR

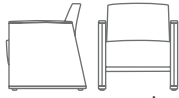

outside			seat			seat to top of back	arm height	weight lbs.	cubic feet
w	d	h	sw	sd	sh				
28	25.75	31	23	20	18	13	25	85	13

model	yds com (54")	sq ft col	com 1	col 2	3	4	5	6	7	8	9	10	11	12	13	14	15	L1	L2	L3
471BHT-1	4	n/a	2,200	2,233	2,271	2,318	2,383	2,477	2,571	2,666	2,760	2,854	2,948	3,042	3,136	3,230	3,324	2,618	2,713	2,806

LOVESEAT

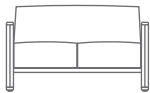

outside			seat			seat to top of back	arm height	weight lbs.	cubic feet
w	d	h	sw	sd	sh				
51	25.75	31	46	20	18	13	25	117	24

model	yds com (54")	sq ft col	com 1	col 2	3	4	5	6	7	8	9	10	11	12	13	14	15	L1	L2	L3
471BHT-2	5.75	n/a	2,900	2,962	3,032	3,120	3,244	3,420	3,597	3,773	3,949	4,126	4,302	4,478	4,655	4,831	5,007	3,659	3,837	4,011

SOFA

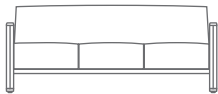

outside			seat			seat to top of back	arm height	weight lbs.	cubic feet
w	d	h	sw	sd	sh				
74	25.75	31	69	20	18	13	25	150	34

model	yds com (54")	sq ft col	com 1	col 2	3	4	5	6	7	8	9	10	11	12	13	14	15	L1	L2	L3
471BHT-3	7.5	n/a	3,500	3,591	3,694	3,823	4,004	4,263	4,522	4,780	5,039	5,297	5,556	5,815	6,073	6,332	6,591	4,600	4,861	5,117

OPTIONS

3DL Arms	Arm Caps	Powder Coat	Foot Rest	Fabric 1
Selection Required	Standard D1N Black	Standard MSL Luster Grey	Standard PAB Black	Selection Required
See page 9 for full list of powder coat options	D1M Taupe Poly D1P Grey Poly A3 Wood (specify finish) Solid Surface \$530 pair CWS Cameo White MWS Modern White CSS Concrete DMS Deep Mink	BWT Bone White BUFF Buff CHLK Chalk SGLD Gold GRPH Graphite MSL Luster Grey HIP Oiled Bronze BKO Onyx POLR Polar SBRZ Soft Bronze HIF Warm Grey	C7V Black C8B Taupe C8A Grey	Fabric : Grade, Vendor, Pattern, Color NOTE: For multiple fabric applications see page 14 for information and pricing

HOW TO ORDER

SPECIFY: Arm Caps | arm cap finish (if applicable) | powder coat | textile pattern and color. See pages 5-14 for information and options on moisture barrier, CAL133, upholstery applications, a complete offering of finishes and ordering details.

MODEL NUMBER

472-1

Arm Caps	Powder Coat	Powder Coat	Foot Rest	Fabric 1
D1N	MSL	MSL	PAB	Grade 5, Momentum, Row, Breeze

SILVR ION METAL LOUNGE STANDARD FEATURES

- Clean-Thru Design
- Upholstered Seat and Back
- Tight Cushion
- Warm Grey (with Silver Ion Antimicrobial) Powder Coat on all Exposed Metal is Standard
- European Beech Arm Caps
- Non-Marring Adjustable Glides

CHAIR



w	outside d	h	sw	seat sd	sh	seat to top of back	arm height	weight lbs.	cubic feet
29	28	31	25	21	18	13	25	75	22

model	yds com (54")	sq ft col	com 1	col 2	3	4	5	6	7	8	9	10	11	12	13	14	15	L1	L2	L3
470-1	2	n/a	1,670	1,703	1,741	1,788	1,853	1,947	2,041	2,136	2,230	2,324	2,418	2,512	2,606	2,700	2,794	2,088	2,183	2,276

LOVESEAT

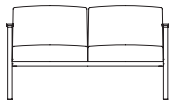

w	outside d	h	sw	seat sd	sh	seat to top of back	arm height	weight lbs.	cubic feet
53.5	28	31	49	21	18	13	25	90	44

model	yds com (54")	sq ft col	com 1	col 2	3	4	5	6	7	8	9	10	11	12	13	14	15	L1	L2	L3
470-2	4	n/a	2,815	2,881	2,956	3,050	3,182	3,370	3,558	3,746	3,934	4,122	4,310	4,498	4,687	4,875	5,063	3,623	3,812	3,999

SOFA

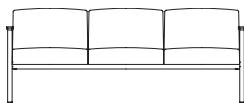

w	outside d	h	sw	seat sd	sh	seat to top of back	arm height	weight lbs.	cubic feet
79	28	31	74	21	18	13	25	120	66

model	yds com (54")	sq ft col	com 1	col 2	3	4	5	6	7	8	9	10	11	12	13	14	15	L1	L2	L3
470-3	6	n/a	3,795	3,894	4,007	4,148	4,345	4,627	4,909	5,192	5,474	5,756	6,038	6,320	6,602	6,884	7,167	4,993	5,277	5,556

OPTIONS

Arm Caps	Powder Coat	Fabric 1
Standard A3 Wood (specify finish)	Standard HIF Warm Grey (with Silver Ion Antimicrobial)	Selection Required
DIN Poly (Black) DIM Poly (Taupe) DIP Poly (Grey)	See page 9 for full list of powder coat options NOTE: Any other powder coat specified will not have Silver Ion antimicrobial technology	Fabric: Grade, Vendor, Pattern, Color NOTE: For multiple fabric applications see page 14 for information and pricing

HOW TO ORDER

SPECIFY: Arm caps | arm cap finish (if applicable) | powder coat | textile pattern and color. See pages 5-14 for information and options on moisture barrier, CAL133, upholstery applications, a complete offering of finishes and ordering details.

MODEL NUMBER

470-1

Arm Caps	Powder Coat	Fabric 1
DIN	HIF	Grade 5, Momentum, Row, Breeze

SILVR ION METAL BENCH STANDARD FEATURES

- Upholstered Solid Seat
- Tight Cushion
- Warm Grey (with Silver Ion Antimicrobial) Powder Coat on all Exposed Metal is Standard
- European Beech Arm Caps
- Non-Marring Adjustable Glides

36" BENCH, SOLID SEAT

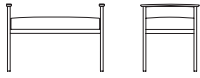

w	outside d	h	sw	seat sd	sh	seat to top of back	arm height	weight lbs.	cubic feet
36.5	21.75	25	32.5	20	19	n/a	25	40	23

model	yds com (54")	sq ft col	com 1	col 2	3	4	5	6	7	8	9	10	11	12	13	14	15	L1	L2	L3
1470-36SS	0.75	n/a	1,271	1,283	1,297	1,315	1,340	1,375	1,410	1,446	1,481	1,516	1,551	1,587	1,622	1,657	1,692	1,445	1,481	1,516

48" BENCH, SOLID SEAT



w	outside d	h	sw	seat sd	sh	seat to top of back	arm height	weight lbs.	cubic feet
48.5	21.75	25	44	20	19	n/a	25	65	31

model	yds com (54")	sq ft col	com 1	col 2	3	4	5	6	7	8	9	10	11	12	13	14	15	L1	L2	L3
1470-48SS	1.5	n/a	1,487	1,512	1,540	1,575	1,625	1,695	1,766	1,836	1,907	1,977	2,048	2,118	2,189	2,259	2,330	1,807	1,879	1,948

70" BENCH, SOLID SEAT



w	outside d	h	sw	seat sd	sh	seat to top of back	arm height	weight lbs.	cubic feet
70.75	21.75	25	66.5	20	19	n/a	25	90	44

model	yds com (54")	sq ft col	com 1	col 2	3	4	5	6	7	8	9	10	11	12	13	14	15	L1	L2	L3
1470-70SS	2	n/a	2,101	2,134	2,172	2,219	2,284	2,378	2,472	2,567	2,661	2,755	2,849	2,943	3,037	3,131	3,225	2,519	2,614	2,707

OPTIONS

Arm Caps	Powder Coat	Fabric 1
Standard A3 Wood (specify finish)	Standard HIF Warm Grey (with Silver Ion Antimicrobial)	Selection Required
DIN Poly (Black) DIM Poly (Taupe) DIP Poly (Grey)	See page 9 for full list of powder coat options NOTE: Any other powder coat specified will not have Silver Ion antimicrobial technology	Fabric: Grade, Vendor, Pattern, Color NOTE: For multiple fabric applications see page 14 for information and pricing

HOW TO ORDER

SPECIFY: Arm caps | arm cap finish (if applicable) | powder coat | textile pattern and color. See pages 5-14 for information and options on moisture barrier, CAL133, upholstery applications, a complete offering of finishes and ordering details.

MODEL NUMBER

1470-36SS

Arm Caps	Powder Coat	Fabric 1
DIN	HIF	Grade 5, Momentum, Row, Breeze

SILVR ION METAL BENCH STANDARD FEATURES

- Upholstered Divided Seat
- Tight Cushion
- Warm Grey (with Silver Ion Antimicrobial) Powder Coat on all Exposed Metal is Standard
- European Beech Arm Caps
- Non-Marring Adjustable Glides

48" BENCH, DIVIDED SEAT

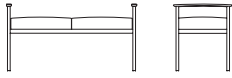

w	outside d			h	sw	seat sd			sh	seat to top of back					arm height	weight lbs.	cubic feet
48.5	21.75			25	44	20			19	n/a					25	65	31

model	yds com (54")	sq ft col	com 1	col																
				2	3	4	5	6	7	8	9	10	11	12	13	14	15	L1	L2	L3
1470-48IS	1.5	n/a	1,582	1,607	1,635	1,670	1,720	1,790	1,861	1,931	2,002	2,072	2,143	2,213	2,284	2,354	2,425	1,902	1,974	2,043

70" BENCH, EVEN DIVIDED SEAT

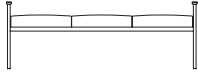

w	outside d			h	sw	seat sd			sh	seat to top of back					arm height	weight lbs.	cubic feet
70.75	21.75			25	66.5	20			19	n/a					25	90	44

model	yds com (54")	sq ft col	com 1	col																
				2	3	4	5	6	7	8	9	10	11	12	13	14	15	L1	L2	L3
1470-70IS	2.25	n/a	2,316	2,353	2,395	2,448	2,522	2,628	2,734	2,840	2,946	3,051	3,157	3,263	3,369	3,475	3,580	2,783	2,889	2,994

70" BENCH, UNEVEN DIVIDED SEAT

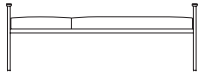

w	outside d			h	sw	seat sd			sh	seat to top of back					arm height	weight lbs.	cubic feet
70.75	21.75			25	66.5	20			19	n/a					25	90	44

model	yds com (54")	sq ft col	com 1	col																
				2	3	4	5	6	7	8	9	10	11	12	13	14	15	L1	L2	L3
1470-70C2	2.25	n/a	2,318	2,355	2,397	2,450	2,524	2,630	2,736	2,842	2,948	3,053	3,159	3,265	3,371	3,477	3,582	2,785	2,891	2,996

OPTIONS

Arm Caps	Powder Coat	Fabric 1
Standard A3 Wood (specify finish)	Standard HIF Warm Grey (with Silver Ion Antimicrobial)	Selection Required
D1N Poly (Black) D1M Poly (Taupe) D1P Poly (Grey)	See page 9 for full list of powder coat options NOTE: Any other powder coat specified will not have Silver Ion antimicrobial technology	Fabric: Grade, Vendor, Pattern, Color NOTE: For multiple fabric applications see page 14 for information and pricing

HOW TO ORDER

SPECIFY: Arm caps | arm cap finish (if applicable) | powder coat | textile pattern and color. See pages 5-14 for information and options on moisture barrier, CAL133, upholstery applications, a complete offering of finishes and ordering details.

MODEL NUMBER

1470-48IS

Arm Caps	Powder Coat	Fabric 1
D1N	HIF	Grade 5, Momentum, Row, Breeze

SILVR ION WOOD LOUNGE STANDARD FEATURES

- Clean-Thru Design
- Upholstered Seat and Back
- Tight Cushion
- Warm Grey (with Silver Ion Antimicrobial) Powder Coat on all Exposed Metal is Standard
- European Beech Arm Caps and Overlay on Legs
- Non-Marring Adjustable Glides

CHAIR

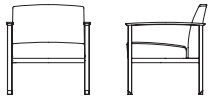

w	outside d	h	sw	seat sd	sh	seat to top of back	arm height	weight lbs.	cubic feet
29	28	31	25	21	18	13	25	75	22

model	yds com (54")	sq ft col	com 1	col 2	3	4	5	6	7	8	9	10	11	12	13	14	15	L1	L2	L3
440-1	2	n/a	1,794	1,827	1,865	1,912	1,977	2,071	2,165	2,260	2,354	2,448	2,542	2,636	2,730	2,824	2,918	2,212	2,307	2,400

LOVESEAT

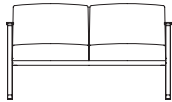

w	outside d	h	sw	seat sd	sh	seat to top of back	arm height	weight lbs.	cubic feet
53.5	28	31	49	21	18	13	25	90	44

model	yds com (54")	sq ft col	com 1	col 2	3	4	5	6	7	8	9	10	11	12	13	14	15	L1	L2	L3
440-2	4	n/a	2,930	2,996	3,071	3,165	3,297	3,485	3,673	3,861	4,049	4,237	4,425	4,613	4,802	4,990	5,178	3,738	3,927	4,114

SOFA

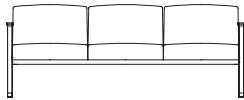

w	outside d	h	sw	seat sd	sh	seat to top of back	arm height	weight lbs.	cubic feet
79	28	31	74	21	18	13	25	120	66

model	yds com (54")	sq ft col	com 1	col 2	3	4	5	6	7	8	9	10	11	12	13	14	15	L1	L2	L3
440-3	6	n/a	3,890	3,989	4,102	4,243	4,440	4,722	5,004	5,287	5,569	5,851	6,133	6,415	6,697	6,979	7,262	5,088	5,372	5,651

OPTIONS

Arm Caps	Finish	Powder Coat	Arm Panel	Fabric 1
Standard A3 Wood	Selection Required	Standard HIF Warm Grey (with Silver Ion Antimicrobial)	Standard X9 No Selection of Option	Selection Required
D1N Poly (Black) D1M Poly (Taupe) D1P Poly (Grey)	See page 9 for full list of finish options	See page 9 for full list of powder coat options NOTE: Any other powder coat specified will not have Silver Ion antimicrobial technology	WAP Pair of Wood (specify finish) \$939 UAP Pair of Upholstered (specify textile) (see pricing below)	Fabric: Grade, Vendor, Pattern, Color NOTE: For multiple fabric applications see page 14 for information and pricing

Arm Panel Options (price per pair)

yds com (54")	sq ft col	com 1	col 2	3	4	5	6	7	8	9	10	11	12	13	14	15	L1	L2	L3
1.5	n/a	546	571	599	634	684	754	825	895	966	1,036	1,107	1,177	1,248	1,318	1,389	866	938	1,007

HOW TO ORDER

SPECIFY: Arm caps | finish | powder coat | arm panel | arm panel finish or textile (if applicable) | textile pattern and color. See pages 5-14 for information and options on moisture barrier, CAL133, upholstery applications, a complete offering of finishes and ordering details.

MODEL NUMBER

440-1

Arm Caps	Finish	Powder Coat	Arm Panel	Fabric 1
D1N	MNW	HIF	X9	Grade 5, Momentum, Row, Breeze

SILVR ION WOOD BENCH STANDARD FEATURES

- Upholstered Solid Seat
- Tight Cushion
- Warm Grey (with Silver Ion Antimicrobial) Powder Coat on all Exposed Metal is Standard
- European Beech Arm Caps and Overlay on Legs
- Non-Marring Adjustable Glides

36" BENCH, SOLID SEAT

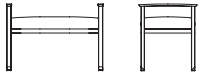

w	outside d	h	sw	seat sd	sh	seat to top of back	arm height	weight lbs.	cubic feet
36.5	21.75	25	32.5	20	19	n/a	25	40	23

model	yds com (54")	sq ft col	com 1	col 2	3	4	5	6	7	8	9	10	11	12	13	14	15	L1	L2	L3
1440-36SS	0.75	n/a	1,458	1,470	1,484	1,502	1,527	1,562	1,597	1,633	1,668	1,703	1,738	1,774	1,809	1,844	1,879	1,632	1,668	1,703

48" BENCH, SOLID SEAT

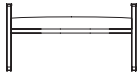

w	outside d	h	sw	seat sd	sh	seat to top of back	arm height	weight lbs.	cubic feet
48.5	21.75	25	44	20	19	n/a	25	65	31

model	yds com (54")	sq ft col	com 1	col 2	3	4	5	6	7	8	9	10	11	12	13	14	15	L1	L2	L3
1440-48SS	1.5	n/a	1,685	1,710	1,738	1,773	1,823	1,893	1,964	2,034	2,105	2,175	2,246	2,316	2,387	2,457	2,528	2,005	2,077	2,146

70" BENCH, SOLID SEAT

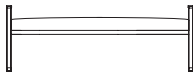

w	outside d	h	sw	seat sd	sh	seat to top of back	arm height	weight lbs.	cubic feet
70.75	21.75	25	66.5	20	19	n/a	25	90	44

model	yds com (54")	sq ft col	com 1	col 2	3	4	5	6	7	8	9	10	11	12	13	14	15	L1	L2	L3
1440-70SS	2	n/a	2,291	2,324	2,362	2,409	2,474	2,568	2,662	2,757	2,851	2,945	3,039	3,133	3,227	3,321	3,415	2,709	2,804	2,897

OPTIONS

Arm Caps	Finish	Powder Coat	Arm Panel	Fabric 1
Standard A3 Wood	Selection Required	Standard HIF Warm Grey (with Silver Ion Antimicrobial)	Standard X9 No Selection of Option	Selection Required
D1N Poly (Black) D1M Poly (Taupe) D1P Poly (Grey)	See page 9 for full list of finish options	See page 9 for full list of powder coat options NOTE: Any other powder coat specified will not have Silver Ion antimicrobial technology	WAP Pair of Wood (specify finish) \$418 UAP Pair of Upholstered (specify textile) (see pricing below)	Fabric: Grade, Vendor, Pattern, Color NOTE: For multiple fabric applications see page 14 for information and pricing

Arm Panel Options (price per pair)

yds com (54")	sq ft col	com 1	col 2	3	4	5	6	7	8	9	10	11	12	13	14	15	L1	L2	L3
0.75	n/a	529	541	555	573	598	633	668	704	739	774	809	845	880	915	950	703	739	774

HOW TO ORDER

SPECIFY: Arm caps | finish | powder coat | arm panel | arm panel finish or textile (if applicable) | textile pattern and color. See pages 5-14 for information and options on moisture barrier, CAL133, upholstery applications, a complete offering of finishes and ordering details.

MODEL NUMBER

1440-36SS

Arm Caps	Finish	Powder Coat	Arm Panel	Fabric 1
D1N	MNW	HIF	X9	Grade 5, Momentum, Row, Breeze

SILVR ION WOOD BENCH STANDARD FEATURES

- Upholstered Divided Seat
- Tight Cushion
- Warm Grey (with Silver Ion Antimicrobial) Powder Coat on all Exposed Metal is Standard
- European Beech Arm Caps and Overlay on Legs
- Non-Marring Adjustable Glides

48" BENCH, DIVIDED SEAT

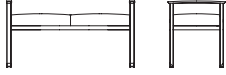

w	outside d	h	sw	seat sd	sh	seat to top of back	arm height	weight lbs.	cubic feet
48.5	21.75	25	44	20	19	n/a	25	65	31

model	yds com (54")	sq ft col	com 1	col 2	3	4	5	6	7	8	9	10	11	12	13	14	15	L1	L2	L3
1440-48IS	1.5	n/a	1,811	1,836	1,864	1,899	1,949	2,019	2,090	2,160	2,231	2,301	2,372	2,442	2,513	2,583	2,654	2,131	2,203	2,272

70" BENCH, EVEN DIVIDED SEAT

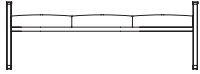

w	outside d	h	sw	seat sd	sh	seat to top of back	arm height	weight lbs.	cubic feet
70.75	21.75	25	66.5	20	19	n/a	25	90	44

model	yds com (54")	sq ft col	com 1	col 2	3	4	5	6	7	8	9	10	11	12	13	14	15	L1	L2	L3
1440-70IS	2.25	n/a	2,560	2,597	2,639	2,692	2,766	2,872	2,978	3,084	3,190	3,295	3,401	3,507	3,613	3,719	3,824	3,027	3,133	3,238

70" BENCH, UNEVEN DIVIDED SEAT

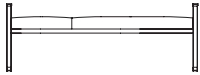

w	outside d	h	sw	seat sd	sh	seat to top of back	arm height	weight lbs.	cubic feet
70.75	21.75	25	66.5	20	19	n/a	25	90	44

model	yds com (54")	sq ft col	com 1	col 2	3	4	5	6	7	8	9	10	11	12	13	14	15	L1	L2	L3
1440-70C2	2.25	n/a	2,516	2,553	2,595	2,648	2,722	2,828	2,934	3,040	3,146	3,251	3,357	3,463	3,569	3,675	3,780	2,983	3,089	3,194

OPTIONS

Arm Caps	Finish	Powder Coat	Arm Panel	Fabric 1
Standard A3 Wood	Selection Required	Standard HIF Warm Grey (with Silver Ion Antimicrobial)	Standard X9 No Selection of Option	Selection Required
DIN Poly (Black) DIM Poly (Taupe) DIP Poly (Grey)	See page 9 for full list of finish options	See page 9 for full list of powder coat options NOTE: Any other powder coat specified will not have Silver Ion antimicrobial technology	WAP Pair of Wood (specify finish) \$418 UAP Pair of Upholstered (specify textile) (see pricing below)	Fabric: Grade, Vendor, Pattern, Color NOTE: For multiple fabric applications see page 14 for information and pricing

Arm Panel Options (price per pair)

yds com (54")	sq ft col	com 1	col 2	3	4	5	6	7	8	9	10	11	12	13	14	15	L1	L2	L3
0.75	n/a	529	541	555	573	598	633	668	704	739	774	809	845	880	915	950	703	739	774

HOW TO ORDER

SPECIFY: Arm caps | finish | powder coat | arm panel | arm panel finish or textile (if applicable) | textile pattern and color. See pages 5-14 for information and options on moisture barrier, CAL133, upholstery applications, a complete offering of finishes and ordering details.

MODEL NUMBER

1440-48IS

Arm Caps	Finish	Powder Coat	Arm Panel	Fabric 1
DIN	MNW	HIF	X9	Grade 5, Momentum, Row, Breeze

VOYAGE CLOSED ARM LOUNGE STANDARD FEATURES

- Clean-Thru Design
- Upholstered Arms, Seat and Back
- V-Stitch on Inside Back
- Tight Cushion
- European Beech Tapered Legs
- Non-Marring Adjustable Glides
- Upholstered Arms without Arm Caps

CHAIR, CLOSED ARM

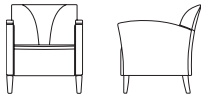

w	outside			sw	seat			seat to top of back	arm height	weight lbs.	cubic feet
	d	h			sd	sh					
27	29	31		21	20.5	17		14	25.5	60	28

model	yds com (54")	sq ft col	com 1	col 2	3	4	5	6	7	8	9	10	11	12	13	14	15	L1	L2	L3
5220-1	4.25	n/a	1,500	1,570	1,650	1,750	1,890	2,090	2,289	2,489	2,689	2,889	3,089	3,289	3,488	3,688	3,888	2,357	2,558	2,756

LOVESEAT, CLOSED ARM

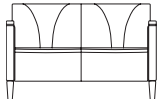

w	outside			sw	seat			seat to top of back	arm height	weight lbs.	cubic feet
	d	h			sd	sh					
48	29	31		42	20.5	17		14	25.5	80	46

model	yds com (54")	sq ft col	com 1	col 2	3	4	5	6	7	8	9	10	11	12	13	14	15	L1	L2	L3
5220-2	5.5	n/a	2,042	2,133	2,236	2,365	2,546	2,805	3,064	3,322	3,581	3,839	4,098	4,357	4,615	4,874	5,133	3,142	3,403	3,659

SOFA, CLOSED ARM

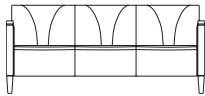

w	outside			sw	seat			seat to top of back	arm height	weight lbs.	cubic feet
	d	h			sd	sh					
69	29	31		63	20.5	17		14	25.5	100	66

model	yds com (54")	sq ft col	com 1	col 2	3	4	5	6	7	8	9	10	11	12	13	14	15	L1	L2	L3
5220-3	7.5	n/a	2,673	2,796	2,938	3,114	3,361	3,713	4,066	4,419	4,771	5,124	5,477	5,829	6,182	6,535	6,887	4,163	4,519	4,868

OPTIONS

Arm Caps	Finish	Fabric 1
Standard X9 No Arm Cap	Selection Required	Selection Required
A4 Poly (Black) \$185 pair	See page 9 for full list of finish options	Fabric: Grade, Vendor, Pattern, Color NOTE: For multiple fabric applications see page 14 for information and pricing

HOW TO ORDER

SPECIFY: Arm caps | wood finish | textile pattern and color. See pages 5-14 for information and options on moisture barrier, CAL133, upholstery applications, a complete offering of finishes and ordering details.

MODEL NUMBER

5220-1

Arm Caps	Finish	Fabric 1
A4	MLC	Grade 5, Momentum, Row, Breeze

VOYAGE CLOSED ARM LOUNGE STANDARD FEATURES

- Clean-Thru Design
- Upholstered Arms, Seat and Back
- V-Stitch on Inside Back
- Tight Cushion
- European Beech Tapered Legs
- Non-Marring Adjustable Glides
- Upholstered Arms without Arm Caps
- Top Options - Beech Veneer or HPL with Matching PVC Edge

CHAIR/CHAIR, CLOSED ARM

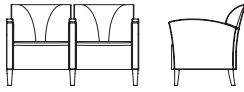

w	outside			sw	seat			seat to top of back	arm height	weight lbs.	cubic feet
	d	h			sd	sh					
51	29	31		21	20.5	17		14	25.5	110	37

model	yds com (54")	sq ft col	com 1	col 2	3	4	5	6	7	8	9	10	11	12	13	14	15	L1	L2	L3
5220-CA	7.5	n/a	2,396	2,519	2,661	2,837	3,084	3,436	3,789	4,142	4,494	4,847	5,200	5,552	5,905	6,258	6,610	3,886	4,242	4,591

CHAIR/CHAIR/CHAIR, CLOSED ARM

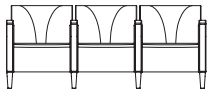

w	outside			sw	seat			seat to top of back	arm height	weight lbs.	cubic feet
	d	h			sd	sh					
75	29	31		21	20.5	17		14	25.5	160	54

model	yds com (54")	sq ft col	com 1	col 2	3	4	5	6	7	8	9	10	11	12	13	14	15	L1	L2	L3
5220-CAA	10.75	n/a	3,504	3,681	3,883	4,136	4,490	4,995	5,501	6,006	6,512	7,017	7,523	8,028	8,534	9,039	9,545	5,628	6,137	6,638

CHAIR/TABLE OR TABLE/CHAIR, CLOSED ARM

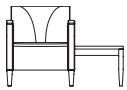

w	outside			sw	seat			seat to top of back	arm height	weight lbs.	cubic feet
	d	h			sd	sh					
46	29	31		21	20.5	17		14	25.5	70	42

model	yds com (54")	sq ft col	com 1	col 2	3	4	5	6	7	8	9	10	11	12	13	14	15	L1	L2	L3
5220-CE/-EC	4.25	n/a	2,205	2,275	2,355	2,455	2,595	2,795	2,994	3,194	3,394	3,594	3,794	3,994	4,193	4,393	4,593	3,062	3,263	3,461

CHAIR/CHAIR/TABLE OR TABLE/CHAIR/CHAIR, CLOSED ARM

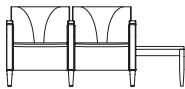

w	outside			sw	seat			seat to top of back	arm height	weight lbs.	cubic feet
	d	h			sd	sh					
70	29	31		21	20.5	17		14	25.5	130	54

model	yds com (54")	sq ft col	com 1	col 2	3	4	5	6	7	8	9	10	11	12	13	14	15	L1	L2	L3
5220-CAE/-EAC	7.5	n/a	3,507	3,630	3,772	3,948	4,195	4,547	4,900	5,253	5,605	5,958	6,311	6,663	7,016	7,369	7,721	4,997	5,353	5,702

CHAIR/TABLE/CHAIR, CLOSED ARM

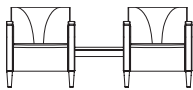

w	outside			sw	seat			seat to top of back	arm height	weight lbs.	cubic feet
	d	h			sd	sh					
73	29	31		21	20.5	17		14	25.5	130	54

model	yds com (54")	sq ft col	com 1	col 2	3	4	5	6	7	8	9	10	11	12	13	14	15	L1	L2	L3
5220-CMC	8.5	n/a	3,215	3,355	3,515	3,715	3,994	4,394	4,794	5,193	5,593	5,993	6,393	6,792	7,192	7,592	7,991	4,900	5,303	5,699

OPTIONS

Arm Caps	Finish	Top (5220-CE/EC/CAE/EAC/CMC only)	Fabric 1
Standard X9 No Arm Cap	Selection Required	Standard X9 Veneer Match to Exposed Wood	Selection Required
A4 Poly (Black) \$93 per Arm Cap	See page 9 for full list of finish options	HPL (Matching PVC Edge) See page 10 for full list of HPL options	Fabric: Grade, Vendor, Pattern, Color NOTE: For multiple fabric applications see page 14 for information and pricing

HOW TO ORDER

SPECIFY: Arm caps | wood finish | Top - Veneer or HPL | textile pattern and color. See pages 5-14 for information and options on moisture barrier, CAL133, upholstery applications, a complete offering of finishes and ordering details.

MODEL NUMBER

5220-CA

Arm Caps	Finish	Top (5220-CE/EC/CAE/EAC/CMC only)	Fabric 1
A4	MLC	X9	Grade 5, Momentum, Row, Breeze

VOYAGE OPEN ARM LOUNGE STANDARD FEATURES

- Clean-Thru Design
- Upholstered Seat and Back
- V-Stitch on Inside Back
- Tight Cushion
- European Beech Open Arm Frame on Top of Upholstered Arm
- European Beech Tapered Wood Legs
- Non-Marring Adjustable Glides

CHAIR, OPEN ARM

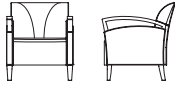

w	outside			sw	seat			seat to top of back	arm height	weight lbs.	cubic feet
	d	h			sd	sh					
27	29	31		21	20.5	17	14	25.5	60	28	

model	yds com (54")	sq ft col	com 1	col 2	3	4	5	6	7	8	9	10	11	12	13	14	15	L1	L2	L3
5220WA-1	4.25	n/a	1,636	1,706	1,786	1,886	2,026	2,226	2,425	2,625	2,825	3,025	3,225	3,425	3,624	3,824	4,024	2,493	2,694	2,892

LOVESEAT, OPEN ARM

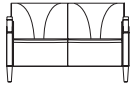

w	outside			sw	seat			seat to top of back	arm height	weight lbs.	cubic feet
	d	h			sd	sh					
48	29	31		42	20.5	17	14	25.5	80	46	

model	yds com (54")	sq ft col	com 1	col 2	3	4	5	6	7	8	9	10	11	12	13	14	15	L1	L2	L3
5220WA-2	5.5	n/a	2,176	2,267	2,370	2,499	2,680	2,939	3,198	3,456	3,715	3,973	4,232	4,491	4,749	5,008	5,267	3,276	3,537	3,793

SOFA, OPEN ARM

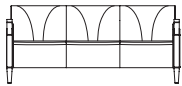

w	outside			sw	seat			seat to top of back	arm height	weight lbs.	cubic feet
	d	h			sd	sh					
69	29	31		63	20.5	17	14	25.5	100	66	

model	yds com (54")	sq ft col	com 1	col 2	3	4	5	6	7	8	9	10	11	12	13	14	15	L1	L2	L3
5220WA-3	7.5	n/a	2,807	2,930	3,072	3,248	3,495	3,847	4,200	4,553	4,905	5,258	5,611	5,963	6,316	6,669	7,021	4,297	4,653	5,002

OPTIONS

Arm Caps	Finish	Fabric 1
Standard X9 No Arm Cap	Selection Required	Selection Required
A4 Poly (Black) \$185 pair	See page 9 for full list of finish options	Fabric: Grade, Vendor, Pattern, Color NOTE: For multiple fabric applications see page 14 for information and pricing

HOW TO ORDER

SPECIFY: Arm caps | finish | textile pattern and color. See pages 5-14 for information and options on moisture barrier, CAL133, upholstery applications, a complete offering of finishes and ordering details.

MODEL NUMBER

5220WA-1

Arm Caps	Finish	Fabric 1
A4	MLC	Grade 5, Momentum, Row, Breeze

VOYAGE OPEN ARM LOUNGE STANDARD FEATURES

- Clean-Thru Design
- Upholstered Seat and Back
- V-Stitch on Inside Back
- Tight Cushion
- European Beech Open Arm Frame on Top of Upholstered Arm
- European Beech Tapered Wood Legs
- Non-Marring Adjustable Glides
- Top Options - Beech Veneer or HPL with Matching PVC Edge

CHAIR/CHAIR, OPEN ARM

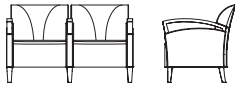

w	outside d	h	sw	seat sd	sh	seat to top of back	arm height	weight lbs.	cubic feet
51	29	31	21	20.5	17	14	25.5	110	37

model	yds com (54")	sq ft col	com 1	col 2	3	4	5	6	7	8	9	10	11	12	13	14	15	L1	L2	L3
5220WA-CA	7.5	n/a	2,598	2,721	2,863	3,039	3,286	3,638	3,991	4,344	4,696	5,049	5,402	5,754	6,107	6,460	6,812	4,088	4,444	4,793

CHAIR/CHAIR/CHAIR, OPEN ARM

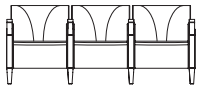

w	outside d	h	sw	seat sd	sh	seat to top of back	arm height	weight lbs.	cubic feet
75	29	31	21	20.5	17	14	25.5	160	54

model	yds com (54")	sq ft col	com 1	col 2	3	4	5	6	7	8	9	10	11	12	13	14	15	L1	L2	L3
5220WA-CAA	10.75	n/a	3,774	3,951	4,153	4,406	4,760	5,265	5,771	6,276	6,782	7,287	7,793	8,298	8,804	9,309	9,815	5,898	6,407	6,908

CHAIR/TABLE OR TABLE/CHAIR, OPEN ARM

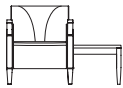

w	outside d	h	sw	seat sd	sh	seat to top of back	arm height	weight lbs.	cubic feet
46	29	31	21	20.5	17	14	25.5	70	42

model	yds com (54")	sq ft col	com 1	col 2	3	4	5	6	7	8	9	10	11	12	13	14	15	L1	L2	L3
5220WA-CE/-EC	4.25	n/a	2,340	2,410	2,490	2,590	2,730	2,930	3,129	3,329	3,529	3,729	3,929	4,129	4,328	4,528	4,728	3,197	3,398	3,596

CHAIR/CHAIR/TABLE OR TABLE/CHAIR/CHAIR, OPEN ARM

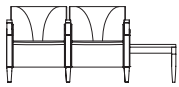

w	outside d	h	sw	seat sd	sh	seat to top of back	arm height	weight lbs.	cubic feet
70	29	31	21	20.5	17	14	25.5	130	54

model	yds com (54")	sq ft col	com 1	col 2	3	4	5	6	7	8	9	10	11	12	13	14	15	L1	L2	L3
5220WA-CAE/-EAC	7.5	n/a	3,709	3,832	3,974	4,150	4,397	4,749	5,102	5,455	5,807	6,160	6,513	6,865	7,218	7,571	7,923	5,199	5,555	5,904

CHAIR/TABLE/CHAIR, OPEN ARM

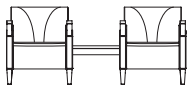

w	outside d	h	sw	seat sd	sh	seat to top of back	arm height	weight lbs.	cubic feet
73	29	31	21	20.5	17	14	25.5	130	54

model	yds com (54")	sq ft col	com 1	col 2	3	4	5	6	7	8	9	10	11	12	13	14	15	L1	L2	L3
5220WA-CMC	8.5	n/a	3,487	3,627	3,787	3,987	4,266	4,666	5,066	5,465	5,865	6,265	6,665	7,064	7,464	7,864	8,263	5,172	5,575	5,971

OPTIONS

Arm Caps	Finish	Top (5220WA-CE/EC/CAE/EAC/CMC only)	Fabric 1
Standard X9 No Arm Cap	Selection Required	Standard X9 Veneer Match to Exposed Wood	Selection Required
A4 Poly (Black) \$93 per Arm Cap	See page 9 for full list of finish options	HPL (Matching PVC Edge) See page 10 for full list of HPL options	Fabric: Grade, Vendor, Pattern, Color NOTE: For multiple fabric applications see page 14 for information and pricing

HOW TO ORDER

SPECIFY: Arm caps | wood finish | Top - Veneer or HPL | textile pattern and color. See pages 5-14 for information and options on moisture barrier, CAL133, upholstery applications, a complete offering of finishes and ordering details.

MODEL NUMBER			
5220WA-CA			
Arm Caps	Finish	Top (5220WA-CE/EC/CAE/EAC/CMC only)	Fabric 1
A4	MLC	X9	Grade 5, Momentum, Row, Breeze

VOYAGE CORNER TABLE STANDARD FEATURES

- Field Installation Required
- European Beech Exposed Wood Frame
- European Beech Tapered Wood Legs
- Ganging Devices
- Non-Marring Adjustable Glides
- Top Options - Beech Veneer or HPL with Matching PVC Edge

CORNER TABLE

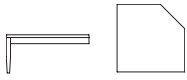

model	w	d	h	wt	cu ft	list
5220-90	34.75	34.75	16	35	18	\$ 1,064

OPTIONS

Base Finish	Top
Selection Required	Standard X9 Veneer Match to Base Finish
See page 9 for full list of finish options	HPL (Matching PVC Edge) See pages 9-10 for full list of finishes and HPL options

HOW TO ORDER

SPECIFY: Base - Finish | Top - Veneer or HPL. See pages 5-14 for a complete offering of finishes and ordering details.

MODEL NUMBER

5220-90

Base Finish	Top
MLC	X9

Y60.G2 FULLY UPHOLSTERED STANDARD FEATURES

- Fully Upholstered Frame
- Spring Seat Construction
- Clean-Thru Design
- Classic Brushed Aluminum Leg is Standard
- Hairpin Legs are Standard Brushed Aluminum, can be Powder Coated

- Chrome Sled Base is a Wall-Saver Design
- Non-Marring Adjustable Glides
- Tablet and Power Options
- Tablet:
- 3/16" Metal Top Overlaid with Specified Veneer

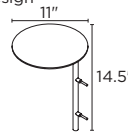

- Tablet Post is Powder Coated any Standard Color
- Post is 3/4" Diameter with two 1/2" Post Offset
- Power Supply:
- Available in Black, White or Silver
- 110/USB
- 10' Power Cord

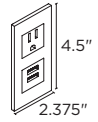

UPHOLSTERED LOUNGE CHAIR

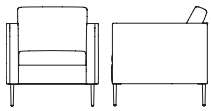

w	outside d	h	sw	seat sd	sh	seat to top of back	arm height	weight lbs.	cubic feet
29	29	32	22	20	17.5	14.5	26	50	16

model	yds com (54")	sq ft col	com 1	col 2	3	4	5	6	7	8	9	10	11	12	13	14	15	L1	L2	L3
689-1	4.5	n/a	1,641	1,715	1,800	1,906	2,054	2,265	2,477	2,688	2,900	3,112	3,323	3,535	3,746	3,958	4,170	2,546	2,760	2,969

UPHOLSTERED LOVESEAT

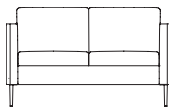

w	outside d	h	sw	seat sd	sh	seat to top of back	arm height	weight lbs.	cubic feet
51	29	32	44	20	17.5	14.5	26	70	27

model	yds com (54")	sq ft col	com 1	col 2	3	4	5	6	7	8	9	10	11	12	13	14	15	L1	L2	L3
689-2	6.5	n/a	2,083	2,190	2,312	2,465	2,679	2,985	3,290	3,596	3,902	4,207	4,513	4,819	5,124	5,430	5,736	3,378	3,686	3,989

UPHOLSTERED SOFA

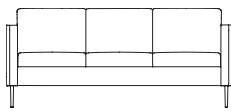

w	outside d	h	sw	seat sd	sh	seat to top of back	arm height	weight lbs.	cubic feet
73	29	32	66	20	17.5	14.5	26	90	39

model	yds com (54")	sq ft col	com 1	col 2	3	4	5	6	7	8	9	10	11	12	13	14	15	L1	L2	L3
689-3	8.25	n/a	2,467	2,603	2,758	2,952	3,223	3,611	3,999	4,387	4,775	5,163	5,551	5,939	6,327	6,715	7,103	4,103	4,494	4,879

OPTIONS

Legs	Arm Caps	Tablet	Power Location	Power Supply	Fabric 1
Standard H3C Classic Brushed Aluminum	Standard X9 No Selection of Option	Standard UP None	Standard UZ No Power	Standard X9 No Selection of Option	Selection Required
H3D Brushed Aluminum Hairpin (specify Powder Coat, see page 9) H3E Chrome Sled Base	A3 Wood \$95 pair Specify finish Solid Surface \$258 pair CWS Cameo White MWS Modern White CSS Concrete DMS Deep Mink	Specify Mech and Top Finish (see page 9) UQ Right Facing \$215 UR Left Facing \$215 US Left and Right Facing \$431 NOTE: Must specify Veneer Top Finish and Powder Coat for Tablet Mech	B6G Left Side Facing Arm \$405 B6H Right Side Facing Arm \$405 B6J Left and Right Facing Arm \$810	WHT White BLK Black SLV Silver	Fabric: Grade, Vendor, Pattern, Color NOTE: For multiple fabric applications see page 14 for information and pricing

HOW TO ORDER

SPECIFY: Legs - Powder coat (if applicable) | Tablet - Location, mechanism powder coat, top finish | Power - Location, power supply color | textile pattern and color. See pages 5-14 for information and options on moisture barrier, CAL133, upholstery applications, a complete offering of finishes and ordering details.

MODEL NUMBER

689-1

Legs	Arm Caps	Tablet	Power Location	Power Supply	Fabric 1
H3C	A3	UQ - BLK - MBM	B6H	BLK	Grade 5, Momentum, Row, Breeze

Y60.G2 WOOD TRIM STANDARD FEATURES

- Fully Upholstered Frame with Hardwood Trim Detail On Arm Panels
- Spring Seat Construction
- Clean-Thru Design
- Classic Brushed Aluminum Leg is Standard
- Hairpin Legs are Standard Brushed Aluminum, can be Powder Coated

- Chrome Sled Base is a Wall-Saver Design
- Non-Marring Adjustable Glides
- Tablet and Power Options
- Tablet:
- 3/16" Metal Top Overlaid with Specified Veneer

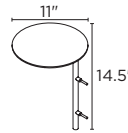

- Tablet Post is Powder Coated any Standard Color
- Post is 3/4" Diameter with two 1/2" Post Offset
- Power Supply:
- Available in Black, White or Silver
- 110/USB
- 10' Power Cord

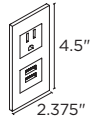

WOOD TRIM LOUNGE CHAIR

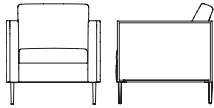

w	outside		sw	seat		seat to top of back	arm height	weight lbs.	cubic feet
	d	h		sd	sh				
29	29	32	22	20	17.5	14.5	26	50	16

model	yds com (54")	sq ft col	com 1	col 2	3	4	5	6	7	8	9	10	11	12	13	14	15	L1	L2	L3
689-1WT	4.25	n/a	1,868	1,938	2,018	2,118	2,258	2,458	2,657	2,857	3,057	3,257	3,457	3,657	3,856	4,056	4,256	2,725	2,926	3,124

WOOD TRIM LOVESEAT

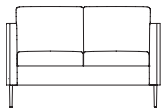

w	outside		sw	seat		seat to top of back	arm height	weight lbs.	cubic feet
	d	h		sd	sh				
51	29	32	44	20	17.5	14.5	26	70	27

model	yds com (54")	sq ft col	com 1	col 2	3	4	5	6	7	8	9	10	11	12	13	14	15	L1	L2	L3
689-2WT	6.25	n/a	2,348	2,451	2,568	2,715	2,921	3,215	3,509	3,803	4,097	4,391	4,684	4,978	5,272	5,566	5,860	3,595	3,891	4,182

WOOD TRIM SOFA

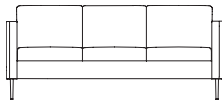

w	outside		sw	seat		seat to top of back	arm height	weight lbs.	cubic feet
	d	h		sd	sh				
73	29	32	66	20	17.5	14.5	26	90	39

model	yds com (54")	sq ft col	com 1	col 2	3	4	5	6	7	8	9	10	11	12	13	14	15	L1	L2	L3
689-3WT	8	n/a	2,766	2,898	3,048	3,236	3,500	3,876	4,252	4,628	5,004	5,380	5,757	6,133	6,509	6,885	7,261	4,354	4,733	5,105

OPTIONS

Legs	Trim Finish	Tablet	Power Location	Power Supply	Fabric 1
Standard H3C Classic Brushed Aluminum	Selection Required	Standard UP None	Standard UZ No Power	Standard X9 No Selection of Option	Selection Required
H3D Brushed Aluminum Hairpin (specify Powder Coat, see page 9) H3E Chrome Sled Base	See page 9 for full list of finish options	Specify Mech and Top Finish (see page 9) UQ Right Facing \$215 UR Left Facing \$215 US Left and Right Facing \$431 NOTE: Must specify Veneer Top Finish and Powder Coat for Tablet Mech	B6G Left Side Facing Arm \$405 B6H Right Side Facing Arm \$405 B6J Left and Right Facing Arm \$810	WHT White BLK Black SLV Silver	Fabric: Grade, Vendor, Pattern, Color NOTE: For multiple fabric applications see page 14 for information and pricing

HOW TO ORDER

SPECIFY: Legs - Powder coat (if applicable) | trim finish | Tablet - Location, mechanism powder coat, top finish | Power - Location, power supply color | textile pattern and color. See pages 5-14 for information and options on moisture barrier, CAL133, upholstery applications, a complete offering of finishes and ordering details.

MODEL NUMBER

689-1WT

Legs	Trim Finish	Tablet	Power Location	Power Supply	Fabric 1
H3C	MBM	UQ - BLK - MBM	B6H	BLK	Grade 5, Momentum, Row, Breeze

Y60.G2 WOOD BACK STANDARD FEATURES

- Fully Upholstered with 3/4" Thick Plywood Shell faced with Quartered Veneer
- Spring Seat Construction
- Clean-Thru Design
- Classic Brushed Aluminum Leg is Standard
- Hairpin Legs are Standard Brushed Aluminum, can be Powder Coated
- Chrome Sled Base is a Wall-Saver Design
- Non-Marring Adjustable Glides
- Tablet and Power Options
- Tablet:
 - 3/16" Metal Top Overlaid with Specified Veneer
- Tablet Post is Powder Coated any Standard Color
- Post is 3/4" Diameter with two 1/2" Post Offset
- Power Supply:
 - Available in Black, White or Silver
 - 110/USB
 - 10' Power Cord

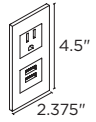
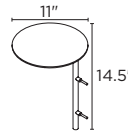

WOOD SURROUND LOUNGE CHAIR

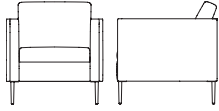

w	outside			sw	seat			seat to top of back	arm height	weight lbs.	cubic feet
	d	h	sd		sh						
28.5	29	32	22	20	17.5	14.5	26	55	16		

model	yds com (54")	sq ft col	com 1	col 2	3	4	5	6	7	8	9	10	11	12	13	14	15	L1	L2	L3
689-1PB	3	n/a	2,387	2,436	2,493	2,563	2,662	2,803	2,944	3,085	3,226	3,367	3,509	3,650	3,791	3,932	4,073	3,000	3,142	3,282

WOOD SURROUND LOVESEAT

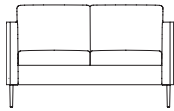

w	outside			sw	seat			seat to top of back	arm height	weight lbs.	cubic feet
	d	h	sd		sh						
50.5	29	32	44	20	17.5	14.5	26	75	27		

model	yds com (54")	sq ft col	com 1	col 2	3	4	5	6	7	8	9	10	11	12	13	14	15	L1	L2	L3
689-2PB	4.75	n/a	3,016	3,094	3,184	3,295	3,452	3,675	3,898	4,122	4,345	4,568	4,792	5,015	5,238	5,462	5,685	3,970	4,195	4,416

WOOD SURROUND SOFA

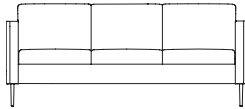

w	outside			sw	seat			seat to top of back	arm height	weight lbs.	cubic feet
	d	h	sd		sh						
72.5	29	32	66	20	17.5	14.5	26	95	39		

model	yds com (54")	sq ft col	com 1	col 2	3	4	5	6	7	8	9	10	11	12	13	14	15	L1	L2	L3
689-3PB	6.5	n/a	3,593	3,700	3,822	3,975	4,189	4,495	4,800	5,106	5,412	5,717	6,023	6,329	6,634	6,940	7,246	4,888	5,196	5,499

OPTIONS

Legs	Surround Finish	Tablet	Power Location	Power Supply	Fabric 1
Standard H3C Classic Brushed Aluminum	Selection Required	Standard UP None	Standard UZ No Power	Standard X9 No Selection of Option	Selection Required
H3D Brushed Aluminum Hairpin (specify Powder Coat, see page 9) H3E Chrome Sled Base	See page 9 for full list of finish options	Specify Mech and Top Finish (see page 9) UQ Right Facing \$215 UR Left Facing \$215 US Left and Right Facing \$431 NOTE: Must specify Veneer Top Finish and Powder Coat for Tablet Mech	B6G Left Side Facing Arm \$405 B6H Right Side Facing Arm \$405 B6J Left and Right Facing Arm \$810	WHT White BLK Black SLV Silver	Fabric: Grade, Vendor, Pattern, Color NOTE: For multiple fabric applications see page 14 for information and pricing

HOW TO ORDER

SPECIFY: Legs - Powder coat (if applicable) | surround finish | Tablet - Location, mechanism powder coat, top finish | Power - Location, power supply color | textile pattern and color. See pages 5-14 for information and options on moisture barrier, CAL133, upholstery applications, a complete offering of finishes and ordering details.

MODEL NUMBER

689-1PB

Legs	Surround Finish	Tablet	Power Location	Power Supply	Fabric 1
H3C	MBM	UQ - BLK - MBM	B6H	BLK	Grade 5, Momentum, Row, Breeze

Y60.G2 WOOD BACK STANDARD FEATURES

- Fully Upholstered
- Spring Seat Construction
- Classic Brushed Aluminum Leg is Standard
- Hairpin Legs are Standard Brushed Aluminum, can be Powder Coated

- Chrome Sled Base is a Wall-Saver Design
- Non-Marring Adjustable Glides
- Power Option

- Power Supply:**
- Available in Black, White or Silver
 - 110/USB
 - 10' Power Cord

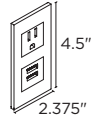

48" BENCH



model	w	d	h	wt	cu ft
689-48	48	24	20	40	24

yds com (54")	sq ft col	com 1	col 2	3	4	5	6	7	8	9	10	11	12	13	14	15	L1	L2	L3
3	n/a	1,055	1,104	1,161	1,231	1,330	1,471	1,612	1,753	1,894	2,035	2,177	2,318	2,459	2,600	2,741	1,668	1,810	1,950

72" BENCH

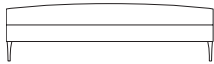

model	w	d	h	wt	cu ft
689-72	72	24	20	60	31

yds com (54")	sq ft col	com 1	col 2	3	4	5	6	7	8	9	10	11	12	13	14	15	L1	L2	L3
4.25	n/a	1,400	1,470	1,550	1,650	1,790	1,990	2,189	2,389	2,589	2,789	2,989	3,189	3,388	3,588	3,788	2,257	2,458	2,656

OPTIONS

Legs	Power Location	Power Supply	Fabric 1
Standard H3C Classic Brushed Aluminum	Standard UZ No Power	Standard X9 No Selection of Option	Selection Required
H3D Brushed Aluminum Hairpin (specify Powder Coat, see page 9) H3E Chrome Sled Base	B6G Left Side Facing Arm \$405 B6H Right Side Facing Arm \$405 B6J Left and Right Facing Arm \$810	WHT White BLK Black SLV Silver	Fabric: Grade, Vendor, Pattern, Color NOTE: For multiple fabric applications see page 14 for information and pricing

HOW TO ORDER

SPECIFY: Legs - Powder coat (if applicable) | Power - Location, power supply color | textile pattern and color. See pages 5-14 for information and options on moisture barrier, CAL133, upholstery applications, a complete offering of finishes and ordering details.

MODEL NUMBER

689-48

Legs	Power Location	Power Supply	Fabric 1
H3C	B6G	BLK	Grade 5, Momentum, Row, Breeze

BASIL

Basil is a broad offering of flexible, modular seating that offers design solutions for any interior space. Straight pieces and curvilinear shapes allow designers to create forms of seating and tables that flow and support the architectural design of spaces. Optional wood and metal arms, metal legs, and numerous table designs support the product's design and its users. Built-in clean-out spaces and polyurethane arm caps make Basil equally durable in high traffic areas.

TYPICALS

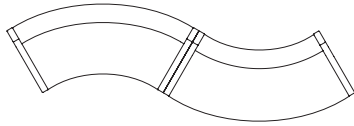

(One) 60 Inside Wedge Loveseat
(One) 60 Outside Wedge Loveseat

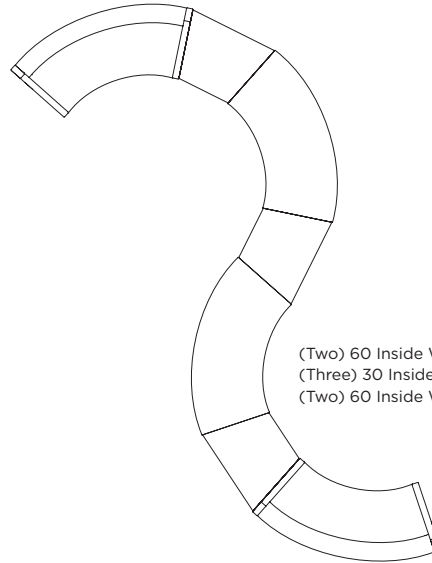

(Two) 60 Inside Wedge Loveseats
(Three) 30 Inside Wedge Tables
(Two) 60 Inside Wedge Benches

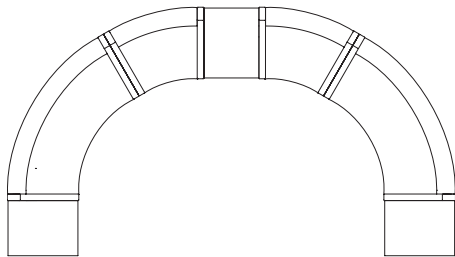

(Two) End Tables
(Two) 60 Inside Wedge Loveseats
(Two) 30 Inside Wedge Chairs
(One) M Table

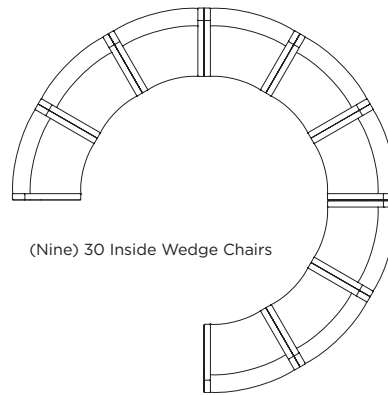

(Nine) 30 Inside Wedge Chairs

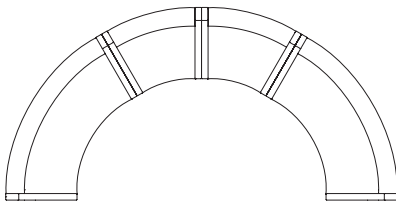

(Two) 60 Inside Wedge Loveseats
(Two) 30 Inside Wedge Chairs

ORDERING EXAMPLE:

- Specify:
- Quantity
- Product by Number
- Arms and Arm Caps
- Leg
- Wood Finish (if applicable)
- Seat Back
- Fabric 1 Grade, Vendor, Pattern and Color

MODEL NUMBER					
5110-1					
Metal Arms	Wood Arms and Arm Caps	Leg	Finish	Seat Back	Fabric 1
X9	EIZ - A4	A4	MNW	L4	Momentum, Row, Breeze

To ensure accuracy please provide Customer Service with a diagram of your specific configuration requirements at time of order.

BASIL LOUNGE MODULAR STANDARD FEATURES

- Armless
- Clean-Thru Design
- Upholstered Seat, Back and Sides on 5110-1 and 5110-2
- Upholstered Seat and Sides on 5110-B42
- Tight Cushion
- European Beech Legs
- Non-Marring Adjustable Glides
- Ganging Devices
- NOTE: Floor Plan Required for any Ganging Configurations

CHAIR

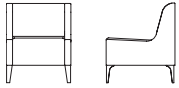

w	outside d	h	sw	seat sd	sh	seat to top of back	arm height	weight lbs.	cubic feet
26	27.5	32	21	20	18	14	n/a	60	27

model	yds com (54")	sq ft col	com 1	col 2	3	4	5	6	7	8	9	10	11	12	13	14	15	L1	L2	L3
5110-1	4	n/a	1,499	1,565	1,640	1,734	1,866	2,054	2,242	2,430	2,618	2,806	2,994	3,182	3,371	3,559	3,747	2,307	2,496	2,683

LOVESEAT

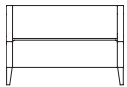

w	outside d	h	sw	seat sd	sh	seat to top of back	arm height	weight lbs.	cubic feet
47	27.5	32	42	20	18	14	n/a	90	40

model	yds com (54")	sq ft col	com 1	col 2	3	4	5	6	7	8	9	10	11	12	13	14	15	L1	L2	L3
5110-2	5	n/a	1,914	1,996	2,090	2,208	2,372	2,608	2,843	3,078	3,313	3,548	3,783	4,018	4,253	4,489	4,724	2,917	3,154	3,387

STRAIGHT BENCH

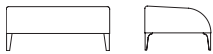

w	outside d	h	sw	seat sd	sh	seat to top of back	arm height	weight lbs.	cubic feet
42	27.5	18	n/a	n/a	n/a	n/a	n/a	75	21

model	yds com (54")	sq ft col	com 1	col 2	3	4	5	6	7	8	9	10	11	12	13	14	15	L1	L2	L3
5110-B42	2.25	n/a	1,044	1,081	1,123	1,176	1,250	1,356	1,462	1,568	1,674	1,779	1,885	1,991	2,097	2,203	2,308	1,511	1,617	1,722

BASIL METAL AND WOOD ARM STANDARD FEATURES

- Not available on Basil Bench Seating
- Brushed Aluminum Finish on Metal Arms
- Poly Arm Caps included on Metal Arm
- European Beech Wood Arm
- Poly Arm Cap optional for Wood Arm

ARM



w	outside d	h	sw	seat sd	sh	seat to top of back	arm height	weight lbs.	cubic feet
2.25	21.25	8.75	n/a	n/a	n/a	n/a	25.25	10	n/a

OPTIONS

Metal Arms	Wood Arms and Arm Caps	Leg	Arm/Leg Finish (if applicable)	Seat Back	Fabric 1
Standard X9 No Selection of Option	Standard X9 No Selection of Option	Standard C8 Wood Leg	Selection Required For EIZ, FIA, FIB and C8 Options	Standard X9 No Selection of Option	Selection Required
Black Poly Arm Cap E1W Left Side Facing \$291 E1X Right Side Facing \$291 E1Y Pair of Arms, Left and Right \$583	Wood (specify finish) E1Z Left Side Facing \$197 F1A Right Side Facing \$197 F1B Pair of Arms, Left and Right \$393 Arm Caps A4 Poly (black) \$105 per arm cap	D1E Brushed Aluminum Metal Leg	See page 9 for full list of finish options	L4 Back Bump Guard \$183	Fabric: Grade, Vendor, Pattern, Color NOTE: For multiple fabric applications see page 14 for information and pricing

HOW TO ORDER

SPECIFY: Arms and arm caps | legs | wood finish (if applicable) | seat back | textile pattern and color. See pages 5-14 for information and options on moisture barrier, CAL133, upholstery applications, a complete offering of finishes and ordering details.

MODEL NUMBER

5110-1

Metal Arms	Wood Arms and Arm Caps	Leg	Arm/Leg Finish (if applicable)	Seat Back	Fabric 1
X9	E1Z - A4	C8	MNW	L4	Grade 5, Momentum, Row, Breeze

BASIL LOUNGE MODULAR STANDARD FEATURES

- Armless
- Clean-Thru Design
- Upholstered Seat, Back and Sides
- Tight Cushion
- European Beech Legs
- Ganging Devices
- Non-Marring Adjustable Glides
- NOTE: Floor Plan Required for any Ganging Configurations

30° INSIDE WEDGE CHAIR

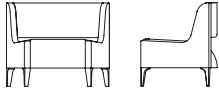

w	outside			sw	seat			seat to top of back	arm height	weight lbs.	cubic feet
	d	h			sd	sh					
39.5	29	32		23	20	18		14	n/a	62	38

model	yds com (54")	sq ft col	com 1	col 2	3	4	5	6	7	8	9	10	11	12	13	14	15	L1	L2	L3
5110-30i	4.75	n/a	1,855	1,933	2,023	2,134	2,291	2,514	2,737	2,961	3,184	3,407	3,631	3,854	4,077	4,301	4,524	2,809	3,034	3,255

30° OUTSIDE WEDGE CHAIR

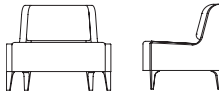

w	outside			sw	seat			seat to top of back	arm height	weight lbs.	cubic feet
	d	h			sd	sh					
39.5	29	32		23	20	18		14	n/a	62	38

model	yds com (54")	sq ft col	com 1	col 2	3	4	5	6	7	8	9	10	11	12	13	14	15	L1	L2	L3
5110-30o	4.75	n/a	1,855	1,933	2,023	2,134	2,291	2,514	2,737	2,961	3,184	3,407	3,631	3,854	4,077	4,301	4,524	2,809	3,034	3,255

BASIL METAL AND WOOD ARM STANDARD FEATURES

- Not available on Basil Bench Seating
- Brushed Aluminum Finish on Metal Arms
- Poly Arm Caps included on Metal Arm
- European Beech Wood Arm
- Poly Arm Cap optional for Wood Arm

ARM



w	outside			sw	seat			seat to top of back	arm height	weight lbs.	cubic feet
	d	h			sd	sh					
2.25	21.25	8.75		n/a	n/a	n/a		n/a	25.25	10	n/a

OPTIONS

Metal Arms	Wood Arms and Arm Caps	Leg	Arm/Leg Finish (if applicable)	Seat Back	Fabric 1
Standard X9 No Selection of Option	Standard X9 No Selection of Option	Standard C8 Wood Leg	Selection Required For EIZ, FIA, FIB and C8 Options	Standard X9 No Selection of Option	Selection Required
With Black Poly Arm Cap E1W Left Side Facing \$291 E1X Right Side Facing \$291 E1Y Pair of Arms, Left and Right \$583	Wood (specify finish) E1Z Left Side Facing \$197 F1A Right Side Facing \$197 F1B Pair of Arms, Left and Right \$393 Arm Caps A4 Poly (black) \$105 per arm cap	D1E Brushed Aluminum Metal Leg	See page 9 for full list of finish options	L4 Back Bump Guard \$183	Fabric: Grade, Vendor, Pattern, Color NOTE: For multiple fabric applications see page 14 for information and pricing

HOW TO ORDER

SPECIFY: Arms and arm caps | legs | wood finish (if applicable) | seat back | textile pattern and color. See pages 5-14 for information and options on moisture barrier, CAL133, upholstery applications, a complete offering of finishes and ordering details.

MODEL NUMBER

5110-301

Metal Arms	Wood Arms and Arm Caps	Leg	Arm/Leg Finish (if applicable)	Seat Back	Fabric 1
X9	E1Z - A4	C8	MNW	L4	Grade 5, Momentum, Row, Breeze

BASIL LOUNGE MODULAR STANDARD FEATURES

- Armless
- Clean-Thru Design
- Upholstered Seat, Back and Sides
- Double Top Stitch in Center of Seat and Back
- Tight Cushion
- European Beech Legs
- Ganging Devices
- Non-Marring Adjustable Glides
- NOTE: Floor Plan Required for any Ganging Configurations

60° INSIDE WEDGE LOVESEAT

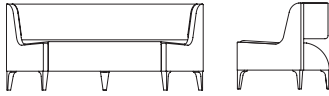

w	outside d	h	sw	seat sd	sh	seat to top of back	arm height	weight lbs.	cubic feet
73	33.75	32	42	20	18	14	n/a	95	80

model	yds com (54")	sq ft col	com 1	col 2	3	4	5	6	7	8	9	10	11	12	13	14	15	L1	L2	L3
5110-60i	7.25	n/a	2,805	2,924	3,061	3,231	3,470	3,811	4,152	4,493	4,833	5,174	5,515	5,856	6,197	6,538	6,879	4,246	4,590	4,928

60° OUTSIDE WEDGE LOVESEAT

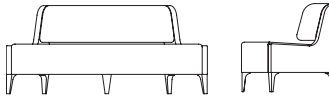

w	outside d	h	sw	seat sd	sh	seat to top of back	arm height	weight lbs.	cubic feet
73	33.75	32	42	20	18	14	n/a	95	80

model	yds com (54")	sq ft col	com 1	col 2	3	4	5	6	7	8	9	10	11	12	13	14	15	L1	L2	L3
5110-60o	7.25	n/a	2,819	2,938	3,075	3,245	3,484	3,825	4,166	4,507	4,847	5,188	5,529	5,870	6,211	6,552	6,893	4,260	4,604	4,942

BASIL METAL AND WOOD ARM STANDARD FEATURES

- Not available on Basil Bench Seating
- Brushed Aluminum Finish on Metal Arms
- Poly Arm Caps included on Metal Arm
- European Beech Wood Arm
- Poly Arm Cap optional for Wood Arm

ARM



w	outside d	h	sw	seat sd	sh	seat to top of back	arm height	weight lbs.	cubic feet
2.25	21.25	8.75	n/a	n/a	n/a	n/a	25.25	10	n/a

OPTIONS

Metal Arms	Wood Arms and Arm Caps	Leg	Arm/Leg Finish (if applicable)	Seat Back	Fabric 1
Standard X9 No Selection of Option	Standard X9 No Selection of Option	Standard C8 Wood Leg	Selection Required For E1Z, F1A, F1B and C8 Options	Standard X9 No Selection of Option	Selection Required
With Black Poly Arm Cap E1W Left Side Facing \$291 E1X Right Side Facing \$291 E1Y Pair of Arms, Left and Right \$583	Wood (specify finish) E1Z Left Side Facing \$197 F1A Right Side Facing \$197 F1B Pair of Arms, Left and Right \$393 Arm Caps A4 Poly (black) \$105 per arm cap	D1E Brushed Aluminum Metal Leg	See page 9 for full list of finish options	L4 Back Bump Guard \$183	Fabric: Grade, Vendor, Pattern, Color NOTE: For multiple fabric applications see page 14 for information and pricing

HOW TO ORDER

SPECIFY: Arms and arm caps | legs | wood finish (if applicable) | seat back | textile pattern and color. See pages 5-14 for information and options on moisture barrier, CAL133, upholstery applications, a complete offering of finishes and ordering details.

MODEL NUMBER

5110-60i

Metal Arms	Wood Arms and Arm Caps	Leg	Arm/Leg Finish (if applicable)	Seat Back	Fabric 1
X9	E1Z - A4	C8	MNW	L4	Grade 5, Momentum, Row, Breeze

BASIL BENCH MODULAR STANDARD FEATURES

- Ganging Devices
- Upholstered Seat and Sides
- Non-Marring Adjustable Glides
- Armless
- Tight Cushion
- NOTE: Floor Plan Required for any Ganging Configurations
- Clean-Thru Design
- European Beech Legs

30° INSIDE WEDGE BENCH



outside			seat			seat to top of back	arm height	weight lbs.	cubic feet
w	d	h	sw	sd	sh				
35	29	18	n/a	n/a	n/a	n/a	n/a	47	16

model	yds com (54")	sq ft col	com 1	col 2	3	4	5	6	7	8	9	10	11	12	13	14	15	L1	L2	L3
5110-b30i	2	n/a	987	1,020	1,058	1,105	1,170	1,264	1,358	1,453	1,547	1,641	1,735	1,829	1,923	2,017	2,111	1,405	1,500	1,593

30° OUTSIDE WEDGE BENCH



outside			seat			seat to top of back	arm height	weight lbs.	cubic feet
w	d	h	sw	sd	sh				
35	29	18	n/a	n/a	n/a	n/a	n/a	47	16

model	yds com (54")	sq ft col	com 1	col 2	3	4	5	6	7	8	9	10	11	12	13	14	15	L1	L2	L3
5110-b30o	2	n/a	987	1,020	1,058	1,105	1,170	1,264	1,358	1,453	1,547	1,641	1,735	1,829	1,923	2,017	2,111	1,405	1,500	1,593

60° INSIDE WEDGE BENCH

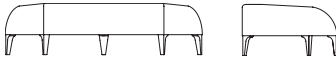

outside			seat			seat to top of back	arm height	weight lbs.	cubic feet
w	d	h	sw	sd	sh				
69	33	18	n/a	n/a	n/a	n/a	n/a	75	35

model	yds com (54")	sq ft col	com 1	col 2	3	4	5	6	7	8	9	10	11	12	13	14	15	L1	L2	L3
5110-b60i	3	n/a	1,514	1,563	1,620	1,690	1,789	1,930	2,071	2,212	2,353	2,494	2,636	2,777	2,918	3,059	3,200	2,127	2,269	2,409

60° OUTSIDE WEDGE BENCH

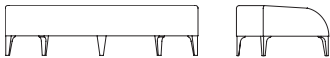

outside			seat			seat to top of back	arm height	weight lbs.	cubic feet
w	d	h	sw	sd	sh				
69	33	18	n/a	n/a	n/a	n/a	n/a	75	34

model	yds com (54")	sq ft col	com 1	col 2	3	4	5	6	7	8	9	10	11	12	13	14	15	L1	L2	L3
5110-b60o	3.25	n/a	1,520	1,573	1,635	1,711	1,818	1,971	2,124	2,276	2,429	2,582	2,735	2,888	3,041	3,193	3,346	2,182	2,336	2,487

90° INSIDE CORNER BENCH



outside			seat			seat to top of back	arm height	weight lbs.	cubic feet
w	d	h	sw	sd	sh				
59	29.5	18	n/a	n/a	n/a	n/a	n/a	67	23

model	yds com (54")	sq ft col	com 1	col 2	3	4	5	6	7	8	9	10	11	12	13	14	15	L1	L2	L3
5110-b90i	2.5	n/a	1,209	1,250	1,297	1,356	1,438	1,556	1,673	1,791	1,908	2,026	2,144	2,261	2,379	2,496	2,614	1,724	1,843	1,959

90° OUTSIDE CORNER BENCH

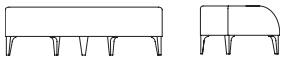

outside			seat			seat to top of back	arm height	weight lbs.	cubic feet
w	d	h	sw	sd	sh				
59	29.5	18	n/a	n/a	n/a	n/a	n/a	67	23

model	yds com (54")	sq ft col	com 1	col 2	3	4	5	6	7	8	9	10	11	12	13	14	15	L1	L2	L3
5110-b90o	2.5	n/a	1,209	1,250	1,297	1,356	1,438	1,556	1,673	1,791	1,908	2,026	2,144	2,261	2,379	2,496	2,614	1,724	1,843	1,959

OPTIONS

Leg	Arm/Leg Finish (if applicable)	Fabric 1
Standard C8 Wood Leg	Selection Required For C8 Option	Selection Required
DIE Brushed Aluminum Metal Leg	See page 9 for full list of finish options	Fabric: Grade, Vendor, Pattern, Color NOTE: For multiple fabric applications see page 14 for information and pricing

HOW TO ORDER

SPECIFY: Legs | wood finish (if applicable) | textile pattern and color. See pages 5-14 for information and options on moisture barrier, CAL133, upholstery applications, a complete offering of finishes and ordering details.

MODEL NUMBER

5110-B30I

Leg	Arm/Leg Finish (if applicable)	Fabric 1
C8	MNW	Grade 5, Momentum, Row, Breeze

BASIL END TABLE STANDARD FEATURES

- Some Field Installation required
- European Beech Legs
- Non-Marring Adjustable Glides
- Ganging Devices
- Top Options - Beech Veneer or HPL with Self Edge
- NOTE: Floor Plan Required for any Ganging Configurations

LEFT STRAIGHT END TABLE



model	w	d	h	wt	cu ft	list
5110-E-LT	21	26.5	9	30	20	\$ 982

RIGHT STRAIGHT END TABLE



model	w	d	h	wt	cu ft	list
5110-E-RT	21	26.5	9	30	20	\$ 982

30° LEFT INSIDE WEDGE END TABLE

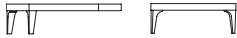

model	w	d	h	wt	cu ft	list
5110-30I-LT	34.75	25.75	9	32	26	\$ 1,226

30° LEFT OUTSIDE WEDGE END TABLE

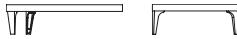

model	w	d	h	wt	cu ft	list
5110-30O-LT	34.75	25.75	9	32	26	\$ 1,226

30° RIGHT INSIDE WEDGE END TABLE



model	w	d	h	wt	cu ft	list
5110-30I-RT	34.75	25.75	9	32	26	\$ 1,226

30° RIGHT OUTSIDE WEDGE END TABLE



model	w	d	h	wt	cu ft	list
5110-30O-RT	34.75	25.75	9	32	26	\$ 1,226

OPTIONS

Leg	Top
Standard C8 Wood Leg (specify finish)	Selection Required
D1E Brushed Aluminum Metal Leg	Veneer (Matching Edge) HPL (Self Edge) See pages 9-10 for full list of finish and HPL options

HOW TO ORDER

SPECIFY: Legs | wood finish (if applicable) | Top - Veneer or HPL. See pages 5-14 for a complete offering of finishes and ordering details.

MODEL NUMBER

5110-E-LT

Leg	Top
D1E	MNW

BASIL CORNER TABLE STANDARD FEATURES

- Some Field Installation required
- European Beech Legs
- Non-Marring Adjustable Glides
- Ganging Devices
- Top Options - Beech Veneer or HPL with Self Edge
- NOTE: Floor Plan Required for any Ganging Configurations

90° INSIDE CORNER TABLE

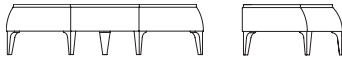

w	outside d	h	sw	seat sd	sh	seat to top of back	arm height	weight lbs.	cubic feet
59	29.5	15	n/a	n/a	n/a	n/a	n/a	72	44

model	yds com (54")	sq ft col	com 1	col 2	3	4	5	6	7	8	9	10	11	12	13	14	15	L1	L2	L3
5110-90I	2	n/a	1,506	1,539	1,577	1,624	1,689	1,783	1,877	1,972	2,066	2,160	2,254	2,348	2,442	2,536	2,630	1,924	2,019	2,112

90° OUTSIDE CORNER TABLE

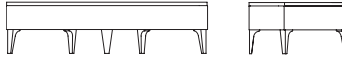

w	outside d	h	sw	seat sd	sh	seat to top of back	arm height	weight lbs.	cubic feet
59	29.5	15	n/a	n/a	n/a	n/a	n/a	72	44

model	yds com (54")	sq ft col	com 1	col 2	3	4	5	6	7	8	9	10	11	12	13	14	15	L1	L2	L3
5110-90O	2	n/a	1,506	1,539	1,577	1,624	1,689	1,783	1,877	1,972	2,066	2,160	2,254	2,348	2,442	2,536	2,630	1,924	2,019	2,112

OPTIONS

Leg	Top	Fabric 1
Standard C8 Wood Leg (specify finish)	Selection Required	Selection Required
DIE Brushed Aluminum Metal Leg	Veneer (Matching Edge) HPL (Self Edge) See pages 9-10 for full list of finish and HPL options	Fabric: Grade, Vendor, Pattern, Color NOTE: For multiple fabric applications see page 14 for information and pricing

HOW TO ORDER

SPECIFY: Legs | wood finish (if applicable) | Top - Veneer or HPL | textile pattern and color. See pages 5-14 for information and options on moisture barrier, CAL133, upholstery applications, a complete offering of finishes and ordering details.

MODEL NUMBER

5110-90I

Leg	Top	Fabric 1
DIE	MNW	Grade 5, Momentum, Row, Breeze

BASIL GANGING TABLE STANDARD FEATURES

- Some Field Installation required
- Ganging Devices
- Top Options - Beech Veneer or HPL with Self Edge
- NOTE: Floor Plan Required for any Ganging Configurations

STRAIGHT MIDDLE TABLE

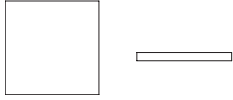

model	w	d	h	wt	cu ft	list
5110-M	21	26.5	2	30	20	\$ 545

30° INSIDE/OUTSIDE WEDGE MIDDLE TABLE

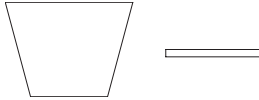

model	w	d	h	wt	cu ft	list
5110-30-I-O	34.75	25.75	2	30	26	\$ 982

60° INSIDE/OUTSIDE WEDGE MIDDLE TABLE

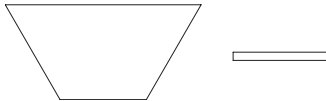

model	w	d	h	wt	cu ft	list
5110-60	47.5	23	2	47	34	\$ 1,002

OPTIONS

Top

Selection Required

Veneer (Matching Edge)
HPL (Self Edge)

See pages 9-10 for full list of finish and HPL options

HOW TO ORDER

SPECIFY: Top - Veneer or HPL. See pages 5-14 for a complete offering of finishes and ordering details.

MODEL NUMBER

5110-M

Top

MNW

MODULAR LOUNGE CORNER SECTION FABRIC DIRECTION

The direction of fabric for the corner section of the modular lounge group must be specified by the customer. If you have a question or concern, please contact your OFS Customer Service Representative.

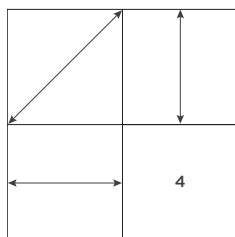
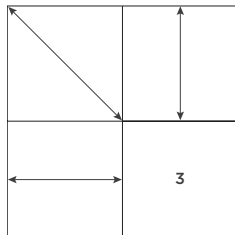
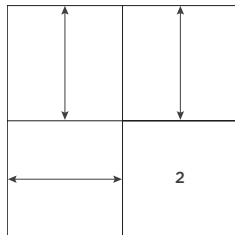
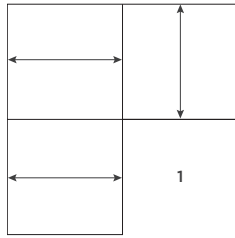

CHAIR/CORNER/CHAIR STANDARD FEATURES

- Luster Grey Powder Coat on All Exposed Metal
- Optional finished Wood Panel - Quartered Grain
- Sinuous Springs in Seat
- Wall-Saver Design
- **NOTE:** The Modular Sectional Units below consist of Two Lounge Chairs located on the Left and Right Sides with a Corner Unit in the Middle that connects the Two Outer Pieces. If ordering Units with Arms, the Arms are located on the Outer End of Lounge Chairs.

ARMLESS

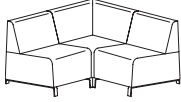

w	outside d	h	sw	seat sd	sh	inside back	arm height	from floor	weight lbs.	cubic feet
55.25	55.25	30	24	20	17.5	15	n/a	n/a	192	105

model	yds com (54")	sq ft col	com 1	col 2	3	4	5	6	7	8	9	10	11	12	13	14	15	L1	L2	L3
with Upholstered Back (VZ)																				
6010-111 VZ	12	240	4,274	4,471	4,697	4,979	5,374	5,939	6,503	7,067	7,631	8,196	8,760	9,324	9,889	10,453	11,017	6,642	7,210	7,769
with Finished Wood Back (WA)																				
6010-111 WA	9	180	5,530	5,678	5,847	6,059	6,355	6,778	7,202	7,625	8,048	8,471	8,895	9,318	9,741	10,164	10,587	7,313	7,739	8,158

UPHOLSTERED ARMS



w	outside d	h	sw	seat sd	sh	inside back	arm height	from floor	weight lbs.	cubic feet
57	57	30	24	20	17.5	15	7.25	24	216	105

model	yds com (54")	sq ft col	com 1	col 2	3	4	5	6	7	8	9	10	11	12	13	14	15	L1	L2	L3
with Upholstered Back (VZ)																				
6011-111 VZ	14	280	4,653	4,883	5,147	5,476	5,937	6,595	7,253	7,912	8,570	9,228	9,887	10,545	11,203	11,862	12,520	7,410	8,074	8,726
with Finished Wood Back (WA)																				
6011-111 WA	11	220	5,941	6,122	6,329	6,588	6,950	7,467	7,984	8,501	9,019	9,536	10,053	10,570	11,088	11,605	12,122	8,114	8,635	9,147

METAL ARMS



w	outside d	h	sw	seat sd	sh	inside back	arm height	from floor	weight lbs.	cubic feet
56.63	56.63	30	24	20	17.5	15	7	23.75	206	105

model	yds com (54")	sq ft col	com 1	col 2	3	4	5	6	7	8	9	10	11	12	13	14	15	L1	L2	L3
with Upholstered Back (VZ)																				
6012-111 VZ	12	240	4,547	4,744	4,970	5,252	5,647	6,212	6,776	7,340	7,904	8,469	9,033	9,597	10,162	10,726	11,290	6,915	7,483	8,042
with Finished Wood Back (WA)																				
6012-111 WA	9	180	5,827	5,975	6,144	6,356	6,652	7,075	7,499	7,922	8,345	8,768	9,192	9,615	10,038	10,461	10,884	7,610	8,036	8,455

OPTIONS

Powder Coat	Arm Caps (6012-111 only)	Back	Finish (WD and WA only)	Fabric/Grade
MSL Luster Grey - Standard	X9 No Arm Caps - Standard WC Upholstered \$89 WD Finished Wood (specify finish) \$89	VZ Upholstered - Standard WA Finished Wood Back Panel (specify finish) NOTE: See individual items for prices	Selection Required See page 9 for full list of finish options	Grade, Vendor, Pattern, Color NOTE: For multiple fabric applications see page 14 for information and pricing
BWT Bone White BUFF Buff CHLK Chalk SGLD Gold GRPH Graphite MSL Luster Grey HIP Oiled Bronze BKO Onyx POLR Polar SBRZ Soft Bronze HIF Warm Grey	Solid Surface \$110 pair CWS Cameo White MWS Modern White CSS Concrete DMS Deep Mink			

HOW TO ORDER

SPECIFY: Powder coat | arm caps (if applicable) | back | Finish (if applicable) | textile pattern and color. When ordering options, a complete description of the option and its upcharge must be detailed on the order form. See pages 5-14 for a complete offering of finishes and graded-in fabric options.

MODEL NUMBER

6012-111

Powder Coat	Arm Caps (6012-111 only)	Back	Finish (WD and WA only)	Fabric/Grade
MSL	WD	WA	MLC	Grade 4, Momentum, Hue, Smoke

CHAIR/CORNER/LOVESEAT STANDARD FEATURES

- Luster Grey Powder Coat on All Exposed Metal
- Optional finished Wood Panel - Quartered Grain
- Sinuous Springs in Seat
- Wall-Saver Design
- **NOTE:** The Modular Sectional Units below consist of a Lounge Chair located on the Left Side and a Loveseat located on the Right Side with a Corner Unit in the Middle that connects the Two Outer Pieces. If ordering Units with Arms, the Arms are located on the Outer Left End of the Lounge Chair and the Outer Right End of the Loveseat.

ARMLESS

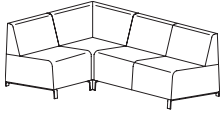

w	outside d	h	sw	seat sd	sh	inside back	arm height	from floor	weight lbs.	cubic feet
79.25	55.25	30	24/48	20	17.5	15	n/a	n/a	238	121

model	yds com (54")	sq ft col	com 1	col 2	3	4	5	6	7	8	9	10	11	12	13	14	15	L1	L2	L3
with Upholstered Back (VZ)																				
6010-112 VZ	13.5	270	4,798	5,020	5,274	5,592	6,036	6,671	7,306	7,940	8,575	9,210	9,845	10,480	11,114	11,749	12,384	7,458	8,098	8,726
with Finished Wood Back (WA)																				
6010-112 WA	11	220	6,263	6,444	6,651	6,910	7,272	7,789	8,306	8,823	9,341	9,858	10,375	10,892	11,410	11,927	12,444	8,436	8,957	9,469

UPHOLSTERED ARMS

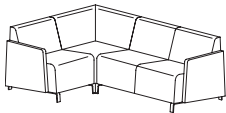

w	outside d	h	sw	seat sd	sh	inside back	arm height	from floor	weight lbs.	cubic feet
81	57	30	24/48	20	17.5	15	7.25	24	262	121

model	yds com (54")	sq ft col	com 1	col 2	3	4	5	6	7	8	9	10	11	12	13	14	15	L1	L2	L3
with Upholstered Back (VZ)																				
6011-112 VZ	15.5	310	5,175	5,430	5,722	6,086	6,596	7,325	8,054	8,783	9,512	10,241	10,969	11,698	12,427	13,156	13,885	8,225	8,960	9,681
with Finished Wood Back (WA)																				
6011-112 WA	12	240	6,630	6,827	7,053	7,335	7,730	8,295	8,859	9,423	9,987	10,552	11,116	11,680	12,245	12,809	13,373	8,998	9,566	10,125

METAL ARMS

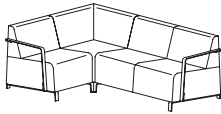

w	outside d	h	sw	seat sd	sh	inside back	arm height	from floor	weight lbs.	cubic feet
80.63	56.63	30	24/48	20	17.5	15	7	23.75	252	121

model	yds com (54")	sq ft col	com 1	col 2	3	4	5	6	7	8	9	10	11	12	13	14	15	L1	L2	L3
with Upholstered Back (VZ)																				
6012-112 VZ	13.5	270	5,058	5,280	5,534	6,852	6,296	6,931	7,566	8,200	8,835	9,470	10,105	10,740	11,374	12,009	12,644	7,718	8,358	8,986
with Finished Wood Back (WA)																				
6012-112 WA	11	220	6,544	6,725	6,932	7,191	7,553	8,070	8,587	9,104	9,622	10,139	10,656	11,173	11,691	12,208	12,725	8,717	9,238	9,750

OPTIONS

Powder Coat	Arm Caps (6012-112 only)	Back	Finish (WD and WA only)	Fabric/Grade
MSL Luster Grey - Standard	X9 No Arm Caps - Standard WC Upholstered \$89 WD Finished Wood (specify finish) \$89	VZ Upholstered - Standard WA Finished Wood Back Panel (specify finish) NOTE: See individual items for prices	Selection Required See page 9 for full list of finish options	Grade, Vendor, Pattern, Color NOTE: For multiple fabric applications see page 14 for information and pricing
BWT Bone White BUFF Buff CHLK Chalk SGLD Gold GRPH Graphite MSL Luster Grey HIP Oiled Bronze BKO Onyx POLR Polar SBRZ Soft Bronze HIF Warm Grey	Solid Surface \$110 pair CWS Cameo White MWS Modern White CSS Concrete DMS Deep Mink			

HOW TO ORDER

SPECIFY: Powder coat | arm caps (if applicable) | back | Finish (if applicable) | textile pattern and color. When ordering options, a complete description of the option and its upcharge must be detailed on the order form. See pages 5-14 for a complete offering of finishes and graded-in fabric options.

MODEL NUMBER

6012-112

Powder Coat	Arm Caps (6012-111 only)	Back	Finish (WD and WA only)	Fabric/Grade
MSL	WD	WA	MLC	Grade 4, Momentum, Hue, Smoke

LOVESEAT/CORNER/CHAIR STANDARD FEATURES

- Luster Grey Powder Coat on All Exposed Metal
- Optional finished Wood Panel - Quartered Grain
- Sinuous Springs in Seat
- Wall-Saver Design
- **NOTE:** The Modular Sectional Units below consist of a Loveseat located on the Left Side and a Lounge Chair located on the Right Side with a Corner Unit in the Middle that connects the Two Outer Pieces. If ordering Units with Arms, the Arms are located on the Outer Left End of the Loveseat and the Outer Right End of the Lounge Chair.

ARMLESS

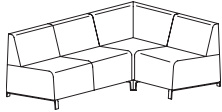

w	outside d	h	sw	seat sd	sh	inside back	arm height	from floor	weight lbs.	cubic feet
55.25	79.25	30	48/24	20	17.5	15	n/a	n/a	238	121

model	yds com (54")	sq ft col	com 1	col 2	3	4	5	6	7	8	9	10	11	12	13	14	15	L1	L2	L3
with Upholstered Back (VZ)																				
6010-211 VZ	13.5	270	4,771	4,993	5,247	5,565	6,009	6,644	7,279	7,913	8,548	9,183	9,818	10,453	11,087	1,722	12,357	7,431	8,071	8,699
with Finished Wood Back (WA)																				
6010-211 WA	11	220	6,233	6,414	6,321	6,880	7,242	7,759	8,276	8,763	9,311	9,828	10,345	10,862	11,380	11,897	12,414	8,406	8,927	9,439

UPHOLSTERED ARMS

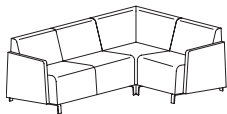

w	outside d	h	sw	seat sd	sh	inside back	arm height	from floor	weight lbs.	cubic feet
57	81	30	48/24	20	17.5	15	7.25	24	262	121

model	yds com (54")	sq ft col	com 1	col 2	3	4	5	6	7	8	9	10	11	12	13	14	15	L1	L2	L3
with Upholstered Back (VZ)																				
6011-211 VZ	15.5	310	5,180	5,435	5,727	6,091	6,601	7,330	8,059	8,788	9,517	10,246	10,974	11,703	12,432	13,161	13,890	8,230	8,965	9,686
with Finished Wood Back (WA)																				
6011-211 WA	12	240	6,635	6,832	7,058	7,340	7,735	8,300	8,864	9,428	9,992	10,557	11,121	11,685	12,250	12,814	13,378	9,003	9,571	10,130

METAL ARMS

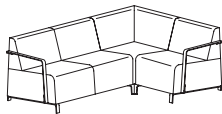

w	outside d	h	sw	seat sd	sh	inside back	arm height	from floor	weight lbs.	cubic feet
56.63	80.63	30	48/24	20	17.5	15	7	23.75	252	121

model	yds com (54")	sq ft col	com 1	col 2	3	4	5	6	7	8	9	10	11	12	13	14	15	L1	L2	L3
with Upholstered Back (VZ)																				
6012-211 VZ	13.5	270	5,051	5,273	5,527	5,845	6,289	6,924	7,559	8,193	8,828	9,463	10,098	10,733	11,367	12,002	12,637	7,711	8,351	9,979
with Finished Wood Back (WA)																				
6012-211 WA	11	220	6,536	7,717	7,924	7,183	7,545	8,062	8,579	9,096	9,614	10,131	11,648	11,165	11,683	12,200	12,717	8,709	9,230	9,742

OPTIONS

Powder Coat	Arm Caps (6012-211 only)	Back	Finish (WD and WA only)	Fabric/Grade
MSL Luster Grey - Standard	X9 No Arm Caps - Standard WC Upholstered \$89 WD Finished Wood (specify finish) \$89	VZ Upholstered - Standard WA Finished Wood Back Panel (specify finish) NOTE: See individual items for prices	Selection Required See page 9 for full list of finish options	Grade, Vendor, Pattern, Color NOTE: For multiple fabric applications see page 14 for information and pricing
BWT Bone White BUFF Buff CHLK Chalk SGLD Gold GRPH Graphite MSL Luster Grey HIP Oiled Bronze BKO Onyx POLR Polar SBRZ Soft Bronze HIF Warm Grey	Solid Surface \$110 pair CWS Cameo White MWS Modern White CSS Concrete DMS Deep Mink			

HOW TO ORDER

SPECIFY: Powder coat | arm caps (if applicable) | back | Finish (if applicable) | textile pattern and color. When ordering options, a complete description of the option and its upcharge must be detailed on the order form. See pages 5-14 for a complete offering of finishes and graded-in fabric options.

MODEL NUMBER

6012-211

Powder Coat	Arm Caps (6012-111 only)	Back	Finish (WD and WA only)	Fabric/Grade
MSL	WD	WA	MLC	Grade 4, Momentum, Hue, Smoke

LOVESEAT/CORNER/LOVESEAT STANDARD FEATURES

- Luster Grey Powder Coat on All Exposed Metal
- Optional finished Wood Panel - Quartered Grain
- Sinuous Springs in Seat
- Wall-Saver Design
- **NOTE:** The Modular Sectional Units below consist of Two Loveseats located on the Left and Right Sides with a Corner Unit in the Middle that connects the Two Outer Pieces. If ordering Units with Arms, the Arms are located on the Outer Left and Right Ends of the Loveseats.

ARMLESS

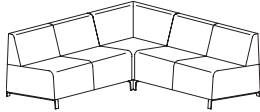

w	outside d	h	sw	seat sd	sh	inside back	arm height	from floor	weight lbs.	cubic feet
79.25	79.25	30	48/48	20	17.5	15	n/a	n/a	284	137

model	yds com (54")	sq ft col	com 1	col 2	3	4	5	6	7	8	9	10	11	12	13	14	15	L1	L2	L3
with Upholstered Back (VZ)																				
6010-212 VZ	15	300	5,277	5,524	5,806	6,159	6,652	7,358	8,063	8,768	9,474	10,179	10,885	11,590	12,295	13,001	13,706	8,229	8,940	9,639
with Finished Wood Back (WA)																				
6010-212 WA	12	240	6,904	7,101	7,327	7,609	8,004	8,569	9,133	9,697	10,261	10,826	11,390	11,954	12,519	13,083	13,647	9,272	9,840	10,399

UPHOLSTERED ARMS

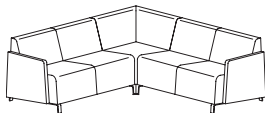

w	outside d	h	sw	seat sd	sh	inside back	arm height	from floor	weight lbs.	cubic feet
81	81	30	48/48	20	17.5	15	7.25	24	308	137

model	yds com (54")	sq ft col	com 1	col 2	3	4	5	6	7	8	9	10	11	12	13	14	15	L1	L2	L3
with Upholstered Back (VZ)																				
6011-212 VZ	17	340	5,682	5,962	6,282	6,681	7,241	8,040	9,840	9,639	10,438	11,238	12,037	13,837	13,363	14,435	15,235	9,024	9,830	10,622
with Finished Wood Back (WA)																				
6011-212 WA	14	280	7,343	7,573	7,837	8,166	8,627	9,285	9,943	10,602	11,260	11,918	12,577	13,235	13,893	14,552	15,210	10,100	10,764	11,416

METAL ARMS

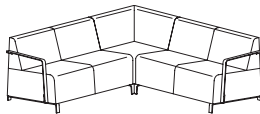

w	outside d	h	sw	seat sd	sh	inside back	arm height	from floor	weight lbs.	cubic feet
80.63	80.63	30	48/48	20	17.5	15	7	23.75	298	137

model	yds com (54")	sq ft col	com 1	col 2	3	4	5	6	7	8	9	10	11	12	13	14	15	L1	L2	L3
with Upholstered Back (VZ)																				
6012-212 VZ	15	300	5,551	5,798	6,080	6,433	6,926	7,632	8,337	9,042	9,748	10,453	11,159	11,864	12,569	13,275	13,980	8,503	9,214	9,913
with Finished Wood Back (WA)																				
6012-212 WA	12	240	7,201	7,398	7,624	7,906	8,301	8,866	9,430	9,994	10,558	11,123	11,687	12,251	12,816	13,380	13,944	9,569	10,137	11,696

OPTIONS

Powder Coat	Arm Caps (6012-212 only)	Back	Finish (WD and WA only)	Fabric/Grade
MSL Luster Grey - Standard	X9 No Arm Caps - Standard WC Upholstered \$89 WD Finished Wood (specify finish) \$89	VZ Upholstered - Standard WA Finished Wood Back Panel (specify finish) NOTE: See individual items for prices	Selection Required See page 9 for full list of finish options	Grade, Vendor, Pattern, Color NOTE: For multiple fabric applications see page 14 for information and pricing
BWT Bone White BUFF Buff CHLK Chalk SGLD Gold GRPH Graphite MSL Luster Grey HIP Oiled Bronze BKO Onyx POLR Polar SBRZ Soft Bronze HIF Warm Grey	Solid Surface \$110 pair CWS Cameo White MWS Modern White CSS Concrete DMS Deep Mink			

HOW TO ORDER

SPECIFY: Powder coat | arm caps (if applicable) | back | Finish (if applicable) | textile pattern and color. When ordering options, a complete description of the option and its upcharge must be detailed on the order form. See pages 5-14 for a complete offering of finishes and graded-in fabric options.

MODEL NUMBER

6012-212

Powder Coat	Arm Caps (6012-111 only)	Back	Finish (WD and WA only)	Fabric/Grade
MSL	WD	WA	MLC	Grade 4, Momentum, Hue, Smoke

CHAIR/CORNER/SOFA STANDARD FEATURES

- Luster Grey Powder Coat on All Exposed Metal
- Optional finished Wood Panel - Quartered Grain
- Sinuous Springs in Seat
- Wall-Saver Design
- **NOTE:** The Modular Sectional Units below consist of a Lounge Chair located on the Left Side and a Sofa located on the Right Side with a Corner Unit in the Middle that connects the Two Outer Pieces. If ordering Units with Arms, the Arms are located on the Outer Left End of the Lounge Chair and the Outer Right End of the Sofa.

ARMLESS

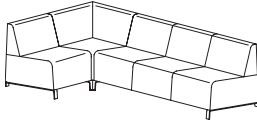

w	outside d	h	sw	seat sd	sh	inside back	arm height	from floor	weight lbs.	cubic feet
103.25	55.25	30	24/72	20	17.5	15	n/a	n/a	273	133

model	yds com (54")	sq ft col	com 1	col 2	3	4	5	6	7	8	9	10	11	12	13	14	15	L1	L2	L3
with Upholstered Back (VZ)																				
6010-113 VZ	16	320	5,381	5,644	5,945	6,321	6,848	7,600	8,353	9,105	9,858	10,610	11,362	12,115	12,867	13,619	14,372	8,528	9,287	10,032
with Finished Wood Back (WA)																				
6010-113 WA	12	240	6,985	7,182	7,408	7,690	8,085	8,650	9,214	9,778	10,342	10,907	11,471	12,035	12,600	13,164	13,728	9,353	9,921	10,480

UPHOLSTERED ARMS

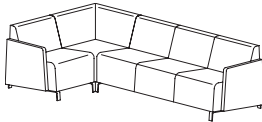

w	outside d	h	sw	seat sd	sh	inside back	arm height	from floor	weight lbs.	cubic feet
105	57	30	24/72	20	17.5	15	7.25	24	297	133

model	yds com (54")	sq ft col	com 1	col 2	3	4	5	6	7	8	9	10	11	12	13	14	15	L1	L2	L3
with Upholstered Back (VZ)																				
6011-113 VZ	17	340	5,743	6,023	6,343	6,742	7,302	8,101	8,901	9,700	10,499	11,299	12,098	12,898	13,637	14,496	15,296	9,085	9,891	10,683
with Finished Wood Back (WA)																				
6011-113 WA	14	280	7,418	7,648	7,912	8,241	8,702	9,360	10,018	10,677	11,335	11,993	12,652	13,310	14,968	14,627	15,285	10,175	10,839	11,491

METAL ARMS

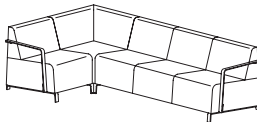

w	outside d	h	sw	seat sd	sh	inside back	arm height	from floor	weight lbs.	cubic feet
104.63	56.63	30	24/72	20	17.5	15	7	23.75	287	133

model	yds com (54")	sq ft col	com 1	col 2	3	4	5	6	7	8	9	10	11	12	13	14	15	L1	L2	L3
with Upholstered Back (VZ)																				
6012-113 VZ	16	320	5,657	5,920	6,221	6,597	7,124	7,876	8,629	9,381	10,134	10,886	11,638	12,391	13,143	13,895	14,648	8,804	9,563	10,308
with Finished Wood Back (WA)																				
6012-113 WA	12	240	7,284	7,481	7,707	7,989	8,384	8,949	9,513	10,077	10,641	11,206	11,770	12,334	12,899	13,463	14,027	9,652	10,220	10,779

OPTIONS

Powder Coat	Arm Caps (6012-113 only)	Back	Finish (WD and WA only)	Fabric/Grade
MSL Luster Grey - Standard	X9 No Arm Caps - Standard WC Upholstered \$89 WD Finished Wood (specify finish) \$89	VZ Upholstered - Standard WA Finished Wood Back Panel (specify finish) NOTE: See individual items for prices	Selection Required See page 9 for full list of finish options	Grade, Vendor, Pattern, Color NOTE: For multiple fabric applications see page 14 for information and pricing
BWT Bone White BUFF Buff CHLK Chalk SGLD Gold GRPH Graphite MSL Luster Grey HIP Oiled Bronze BKO Onyx POLR Polar SBRZ Soft Bronze HIF Warm Grey	Solid Surface \$110 pair CWS Cameo White MWS Modern White CSS Concrete DMS Deep Mink			

HOW TO ORDER

SPECIFY: Powder coat | arm caps (if applicable) | back | finish (if applicable) | textile pattern and color. When ordering options, a complete description of the option and its upcharge must be detailed on the order form. See pages 5-14 for a complete offering of finishes and graded-in fabric options.

MODEL NUMBER

6012-113

Powder Coat	Arm Caps (6012-111 only)	Back	Finish (WD and WA only)	Fabric/Grade
MSL	WD	WA	MLC	Grade 4, Momentum, Hue, Smoke

SOFA/CORNER/CHAIR STANDARD FEATURES

- Luster Grey Powder Coat on All Exposed Metal
- Optional finished Wood Panel - Quartered Grain
- Sinuous Springs in Seat
- Wall-Saver Design
- **NOTE:** The Modular Sectional Units below consist of a Sofa located on the Left Side and a Lounge Chair located on the Right Side with a Corner Unit in the Middle that connects the Two Outer Pieces. If ordering Units with Arms, the Arms are located on the Outer Left End of the Sofa and the Outer Right End of the Lounge Chair.

ARMLESS

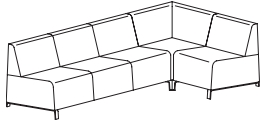

w	outside		sw	seat		inside back	arm height	from floor	weight lbs.	cubic feet
	d	h		sd	sh					
55.25	103.25	30	72/24	20	17.5	15	n/a	n/a	273	133

model	yds com (54")	sq ft col	com 1	col 2	3	4	5	6	7	8	9	10	11	12	13	14	15	L1	L2	L3
with Upholstered Back (VZ)																				
6010-311 VZ	16	320	5,302	5,565	5,866	6,242	6,769	7,521	8,274	9,026	9,779	10,531	11,283	12,036	12,788	13,540	14,293	8,449	9,208	9,953
with Finished Wood Back (WA)																				
6010-311 WA	12	240	6,899	7,096	7,322	7,604	7,999	8,564	9,128	9,692	10,256	10,821	11,385	11,949	12,514	13,078	13,642	9,267	9,835	10,394

UPHOLSTERED ARMS

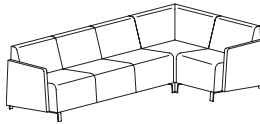

w	outside		sw	seat		inside back	arm height	from floor	weight lbs.	cubic feet
	d	h		sd	sh					
57	105	30	72/24	20	17.5	15	7.25	24	297	133

model	yds com (54")	sq ft col	com 1	col 2	3	4	5	6	7	8	9	10	11	12	13	14	15	L1	L2	L3
with Upholstered Back (VZ)																				
6011-311 VZ	17	340	5,665	5,945	6,265	6,664	7,224	8,023	8,823	9,622	10,421	11,221	12,020	12,820	13,619	14,418	15,218	9,007	9,813	10,605
with Finished Wood Back (WA)																				
6011-311 WA	14	280	7,334	7,564	7,828	8,157	8,618	9,276	9,934	10,593	11,251	11,909	12,568	13,226	13,884	14,543	15,201	10,091	10,755	11,407

METAL ARMS

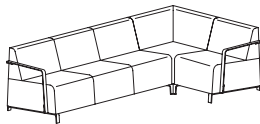

w	outside		sw	seat		inside back	arm height	from floor	weight lbs.	cubic feet
	d	h		sd	sh					
56.63	104.63	30	72/24	20	17.5	15	7	23.75	287	133

model	yds com (54")	sq ft col	com 1	col 2	3	4	5	6	7	8	9	10	11	12	13	14	15	L1	L2	L3
with Upholstered Back (VZ)																				
6012-311 VZ	16	320	5,553	5,816	6,117	6,493	7,020	7,772	8,525	9,277	10,030	10,782	11,534	12,287	13,039	13,791	14,544	8,700	9,459	10,204
with Finished Wood Back (WA)																				
6012-311 WA	12	240	7,171	7,368	7,594	7,876	8,271	8,836	9,400	9,964	10,528	11,093	11,657	12,221	12,786	13,350	13,914	9,539	10,107	10,666

OPTIONS

Powder Coat	Arm Caps (6012-311 only)	Back	Finish (WD and WA only)	Fabric/Grade
MSL Luster Grey - Standard	X9 No Arm Caps - Standard WC Upholstered \$89 WD Finished Wood (specify finish) \$89	VZ Upholstered - Standard WA Finished Wood Back Panel (specify finish) NOTE: See individual items for prices	Selection Required See page 9 for full list of finish options	Grade, Vendor, Pattern, Color NOTE: For multiple fabric applications see page 14 for information and pricing
BWT Bone White BUFF Buff CHLK Chalk SGLD Gold GRPH Graphite MSL Luster Grey HIP Oiled Bronze BKO Onyx POLR Polar SBRZ Soft Bronze HIF Warm Grey	Solid Surface \$110 pair CWS Cameo White MWS Modern White CSS Concrete DMS Deep Mink			

HOW TO ORDER

SPECIFY: Powder coat | arm caps (if applicable) | back | finish (if applicable) | textile pattern and color. When ordering options, a complete description of the option and its upcharge must be detailed on the order form. See pages 5-14 for a complete offering of finishes and graded-in fabric options.

MODEL NUMBER				
6012-311				
Powder Coat	Arm Caps (6012-111 only)	Back	Finish (WD and WA only)	Fabric/Grade
MSL	WD	WA	MLC	Grade 4, Momentum, Hue, Smoke

LOVESEAT/CORNER/SOFA STANDARD FEATURES

- Luster Grey Powder Coat on All Exposed Metal
- Optional finished Wood Panel - Quartered Grain
- Sinuous Springs in Seat
- Wall-Saver Design
- **NOTE:** The Modular Sectional Units below consist of a Loveseat located on the Left Side and a Sofa located on the Right Side with a Corner Unit in the Middle that connects the Two Outer Pieces. If ordering Units with Arms, the Arms are located on the Outer Left End of the Loveseat and the Outer Right End of the Sofa.

ARMLESS

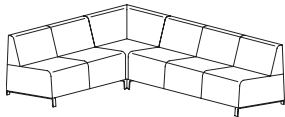

w	outside			sw	seat			inside back	arm height	from floor	weight lbs.	cubic feet
	d	h	sd		sh							
103.25	79.25	30	48/72	20	17.5	15	n/a	n/a	319	149		

model	yds com (54")	sq ft col	com 1	col 2	3	4	5	6	7	8	9	10	11	12	13	14	15	L1	L2	L3
with Upholstered Back (VZ)																				
6010-213 VZ	18	360	5,802	6,098	6,437	6,860	7,453	8,299	9,145	9,992	10,838	11,685	12,531	13,377	14,224	15,070	15,917	9,339	10,192	11,030
with Finished Wood Back (WA)																				
6010-213 WA	13	260	7,543	7,757	8,001	8,307	8,735	9,346	9,958	10,569	11,180	11,792	12,403	13,014	13,625	14,237	14,848	10,105	10,722	11,327

UPHOLSTERED ARMS

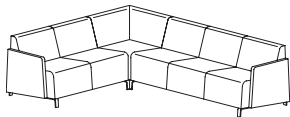

w	outside			sw	seat			inside back	arm height	from floor	weight lbs.	cubic feet
	d	h	sd		sh							
105	81	30	48/72	20	17.5	15	7.25	24	343	149		

model	yds com (54")	sq ft col	com 1	col 2	3	4	5	6	7	8	9	10	11	12	13	14	15	L1	L2	L3
with Upholstered Back (VZ)																				
6011-213 VZ	19	380	6,199	6,512	6,869	7,316	7,941	8,835	9,728	10,622	11,515	12,408	13,302	14,195	15,089	15,982	16,876	9,931	10,832	11,716
with Finished Wood Back (WA)																				
6011-213 WA	15	300	8,015	8,262	8,544	8,897	9,390	10,096	10,801	11,506	12,212	12,917	13,623	14,328	15,033	15,739	16,444	10,967	11,678	11,652

METAL ARMS

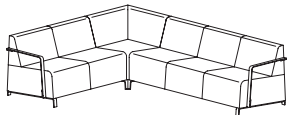

w	outside			sw	seat			inside back	arm height	from floor	weight lbs.	cubic feet
	d	h	sd		sh							
104.63	80.63	30	48/72	20	17.5	15	7	23.75	333	149		

model	yds com (54")	sq ft col	com 1	col 2	3	4	5	6	7	8	9	10	11	12	13	14	15	L1	L2	L3
with Upholstered Back (VZ)																				
6012-213 VZ	18	360	6,102	6,398	6,737	7,160	7,753	8,599	9,445	10,292	11,138	11,985	12,831	13,677	14,524	15,370	16,217	9,639	10,492	11,330
with Finished Wood Back (WA)																				
6012-213 WA	13	260	7,868	8,082	8,326	8,632	9,060	9,671	10,283	10,894	11,505	12,117	12,728	13,339	13,950	14,562	15,173	10,430	11,047	11,652

OPTIONS

Powder Coat	Arm Caps (6012-213 only)	Back	Finish (WD and WA only)	Fabric/Grade
MSL Luster Grey - Standard	X9 No Arm Caps - Standard WC Upholstered \$89 WD Finished Wood (specify finish) \$89	VZ Upholstered - Standard WA Finished Wood Back Panel (specify finish) NOTE: See individual items for prices	Selection Required See page 9 for full list of finish options	Grade, Vendor, Pattern, Color NOTE: For multiple fabric applications see page 14 for information and pricing
BWT Bone White BUFF Buff CHLK Chalk SGLD Gold GRPH Graphite MSL Luster Grey HIP Oiled Bronze BKO Onyx POLR Polar SBRZ Soft Bronze HIF Warm Grey	Solid Surface \$110 pair CWS Cameo White MWS Modern White CSS Concrete DMS Deep Mink			

HOW TO ORDER

SPECIFY: Powder coat | arm caps (if applicable) | back | finish (if applicable) | textile pattern and color. When ordering options, a complete description of the option and its upcharge must be detailed on the order form. See pages 5-14 for a complete offering of finishes and graded-in fabric options.

MODEL NUMBER

6012-213

Powder Coat	Arm Caps (6012-111 only)	Back	Finish (WD and WA only)	Fabric/Grade
MSL	WD	WA	MLC	Grade 4, Momentum, Hue, Smoke

SOFA/CORNER/LOVESEAT STANDARD FEATURES

- Luster Grey Powder Coat on All Exposed Metal
- Optional finished Wood Panel - Quartered Grain
- Sinuous Springs in Seat
- Wall-Saver Design
- **NOTE:** The Modular Sectional Units below consist of a Sofa located on the Left Side and a Loveseat located on the Right Side with a Corner Unit in the Middle that connects the Two Outer Pieces. If ordering Units with Arms, the Arms are located on the Outer Left End of the Sofa and the Outer Right End of the Loveseat.

ARMLESS

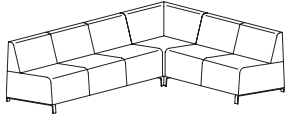

w	outside			sw	seat			inside back	arm height	from floor	weight lbs.	cubic feet
	d	h	sd		sh							
79.25	103.25	30	72/48	20	17.5	15	n/a	n/a	319	149		

model	yds com (54")	sq ft col	com 1	col 2	3	4	5	6	7	8	9	10	11	12	13	14	15	L1	L2	L3
with Upholstered Back (VZ)																				
6010-312 VZ	18	360	5,749	6,045	6,384	6,807	7,400	8,246	9,092	9,939	10,785	11,632	12,478	13,324	14,171	15,017	15,864	9,286	10,139	10,977
with Finished Wood Back (WA)																				
6010-312 WA	13	260	7,486	7,700	7,944	8,250	8,678	9,289	9,901	10,512	11,123	11,735	12,346	12,957	13,568	14,180	14,791	10,048	10,665	11,270

UPHOLSTERED ARMS

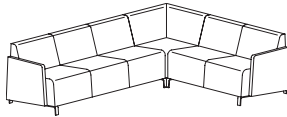

w	outside			sw	seat			inside back	arm height	from floor	weight lbs.	cubic feet
	d	h	sd		sh							
81	105	30	72/48	20	17.5	15	7.25	24	343	149		

model	yds com (54")	sq ft col	com 1	col 2	3	4	5	6	7	8	9	10	11	12	13	14	15	L1	L2	L3
with Upholstered Back (VZ)																				
6011-312 VZ	19	380	6,115	6,428	6,785	7,232	7,857	8,751	9,644	10,538	11,431	12,324	13,218	14,111	15,005	15,898	16,792	9,847	10,748	11,632
with Finished Wood Back (WA)																				
6011-312 WA	15	300	7,923	8,170	8,452	8,805	9,298	10,004	10,709	11,414	12,120	12,825	13,531	14,236	14,941	15,647	16,352	10,875	11,586	12,285

METAL ARMS

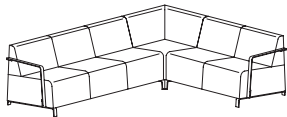

w	outside			sw	seat			inside back	arm height	from floor	weight lbs.	cubic feet
	d	h	sd		sh							
80.63	104.63	30	72/48	20	17.5	15	7	23.75	333	149		

model	yds com (54")	sq ft col	com 1	col 2	3	4	5	6	7	8	9	10	11	12	13	14	15	L1	L2	L3
with Upholstered Back (VZ)																				
6012-312 VZ	18	360	5,997	6,293	6,632	7,055	7,648	8,494	9,340	10,187	11,033	11,880	12,726	13,572	14,419	15,265	16,112	9,534	10,387	11,225
with Finished Wood Back (WA)																				
6012-312 WA	13	260	7,754	7,968	8,212	8,518	8,946	9,557	10,169	10,780	11,391	12,003	12,614	13,225	13,836	14,448	15,059	10,316	10,933	11,538

OPTIONS

Powder Coat	Arm Caps (6012-312 only)	Back	Finish (WD and WA only)	Fabric/Grade
MSL Luster Grey - Standard	X9 No Arm Caps - Standard WC Upholstered \$89 WD Finished Wood (specify finish) \$89	VZ Upholstered - Standard WA Finished Wood Back Panel (specify finish) NOTE: See individual items for prices	Selection Required See page 9 for full list of finish options	Grade, Vendor, Pattern, Color NOTE: For multiple fabric applications see page 14 for information and pricing
BWT Bone White BUFF Buff CHLK Chalk SGLD Gold GRPH Graphite MSL Luster Grey HIP Oiled Bronze BKO Onyx POLR Polar SBRZ Soft Bronze HIF Warm Grey	Solid Surface \$110 pair CWS Cameo White MWS Modern White CSS Concrete DMS Deep Mink			

HOW TO ORDER

SPECIFY: Powder coat | arm caps (if applicable) | back | finish (if applicable) | textile pattern and color. When ordering options, a complete description of the option and its upcharge must be detailed on the order form. See pages 5-14 for a complete offering of finishes and graded-in fabric options.

MODEL NUMBER

6012-312

Powder Coat	Arm Caps (6012-111 only)	Back	Finish (WD and WA only)	Fabric/Grade
MSL	WD	WA	MLC	Grade 4, Momentum, Hue, Smoke

SOFA/CORNER/SOFA STANDARD FEATURES

- Luster Grey Powder Coat on All Exposed Metal
 - Optional finished Wood Panel - Quartered Grain
 - Sinuous Springs in Seat
 - Wall-Saver Design
- **NOTE:** The Modular Sectional Units below consist of Two Sofas located on the Left and Right Sides with a Corner Unit in the Middle that connects the Two Outer Pieces. If ordering Units with Arms, the Arms are located on the Outer Left and Right Ends of the Sofas.

ARMLESS

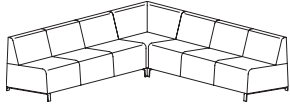

w	outside d	h	sw	seat sd	sh	inside back	arm height	from floor	weight lbs.	cubic feet
103.25	103.25	30	72/72	20	17.5	15	n/a	n/a	354	161

model	yds com (54")	sq ft col	com 1	col 2	3	4	5	6	7	8	9	10	11	12	13	14	15	L1	L2	L3
with Upholstered Back (VZ)																				
6010-313 VZ	20	400	6,349	6,678	7,054	7,525	8,183	9,123	10,064	11,004	11,945	12,885	13,826	14,766	15,707	16,647	17,588	10,276	11,224	12,155
with Finished Wood Back (WA)																				
6010-313 WA	14	280	8,248	8,478	8,742	9,071	9,532	10,190	10,848	11,507	12,165	12,823	13,482	14,140	14,798	15,457	16,115	11,005	11,669	12,321

UPHOLSTERED ARMS

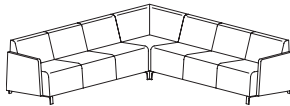

w	outside d	h	sw	seat sd	sh	inside back	arm height	from floor	weight lbs.	cubic feet
105	105	30	72/72	20	17.5	15	7.25	24	378	161

model	yds com (54")	sq ft col	com 1	col 2	3	4	5	6	7	8	9	10	11	12	13	14	15	L1	L2	L3
with Upholstered Back (VZ)																				
6011-313 VZ	21	420	6,719	7,065	7,460	7,953	8,645	9,632	10,620	11,607	12,595	13,582	14,570	15,557	16,544	17,532	18,519	10,841	11,837	12,814
with Finished Wood Back (WA)																				
6011-313 WA	16	320	8,690	8,953	9,254	9,630	10,157	10,909	11,662	12,414	13,167	13,919	14,671	15,424	16,176	16,928	17,681	11,837	12,596	13,583

METAL ARMS

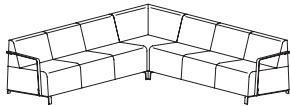

w	outside d	h	sw	seat sd	sh	inside back	arm height	from floor	weight lbs.	cubic feet
104.63	104.63	30	72/72	20	17.5	15	7	23.75	368	161

model	yds com (54")	sq ft col	com 1	col 2	3	4	5	6	7	8	9	10	11	12	13	14	15	L1	L2	L3
with Upholstered Back (VZ)																				
6012-313 VZ	20	400	6,592	6,921	7,291	7,768	8,426	9,366	10,307	11,247	12,188	13,128	14,069	15,009	15,950	16,890	17,831	10,519	11,467	12,398
with Finished Wood Back (WA)																				
6012-313 WA	14	280	8,510	8,740	9,004	9,133	9,794	10,452	11,110	11,796	12,427	13,085	13,744	14,402	15,060	15,719	16,377	11,267	11,931	12,583

OPTIONS

Powder Coat	Arm Caps (6012-313 only)	Back	Finish (WD and WA only)	Fabric/Grade
MSL Luster Grey - Standard	X9 No Arm Caps - Standard WC Upholstered \$89 WD Finished Wood (specify finish) \$89	VZ Upholstered - Standard WA Finished Wood Back Panel (specify finish) NOTE: See individual items for prices	Selection Required See page 9 for full list of finish options	Grade, Vendor, Pattern, Color NOTE: For multiple fabric applications see page 14 for information and pricing
BWT Bone White BUFF Buff CHLK Chalk SGLD Gold GRPH Graphite MSL Luster Grey HIP Oiled Bronze BKO Onyx POLR Polar SBRZ Soft Bronze HIF Warm Grey	Solid Surface \$110 pair CWS Cameo White MWS Modern White CSS Concrete DMS Deep Mink			

HOW TO ORDER

SPECIFY: Powder coat | arm caps (if applicable) | back | finish (if applicable) | textile pattern and color. When ordering options, a complete description of the option and its upcharge must be detailed on the order form. See pages 5-14 for a complete offering of finishes and graded-in fabric options.

MODEL NUMBER

6012-313

Powder Coat	Arm Caps (6012-111 only)	Back	Finish (WD and WA only)	Fabric/Grade
MSL	WD	WA	MLC	Grade 4, Momentum, Hue, Smoke

RETROSPECT

Retrospect looks better than ever! Fresh, modern, clean lines allow specifiers to personalize and update space designs. Optional arm designs, back placements, leg options, hang tables, bolster pillows and tablet options all support a series of benches in various sizes to offer a collection that is both flexible and stylish. The addition of benches that are scaled for children's areas adds complimentary seating for all visitors. Occasional tables that support the series are also available.

TYPICALS

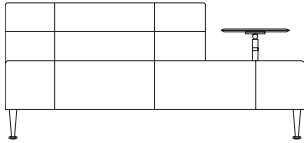

7010-FB-X9-LK1-F1-F4

- 7010» Retrospect series
- FB» Indicates sofa bench
- X9» Indicates satin aluminum legs
- LK1» Indicates loveseat back, left back position
- F1-F4» Indicates circle tablet, right back long side position

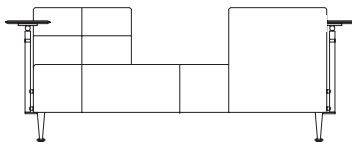

7010-FB-X9-SK1/6-E9-F9-H1

- 7010» Retrospect series
- FB» Indicates sofa bench
- X9» Indicates satin aluminum legs
- SK1/6» Indicates single back, left back and right front positions
- E9-F9-H1» Indicates oval tablet, right back short side and left front short side positions

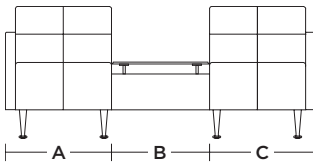

Order each bench configuration individually:

- Section A: 7010-SB-SK2-C1A
- Section B: 7010-H5
- Section C: 7010-SB-SK2-C1E

To ensure accuracy please provide Customer Service with a diagram of your specific configuration requirements at time of order.

RETROSPECT

CONFIGURING AND ORDERING

Retrospect is a modular lounge collection that configures to your space needs. Create chairs, benches, loveseats, sofas, tete-a-tetes, or just about any piece you want. Add casters, arm styles, and tables to fit your specific application. By following these steps, and submitting a drawing to customer service for your Retrospect seating order, it will be clearly indicated and correctly entered and acknowledged.

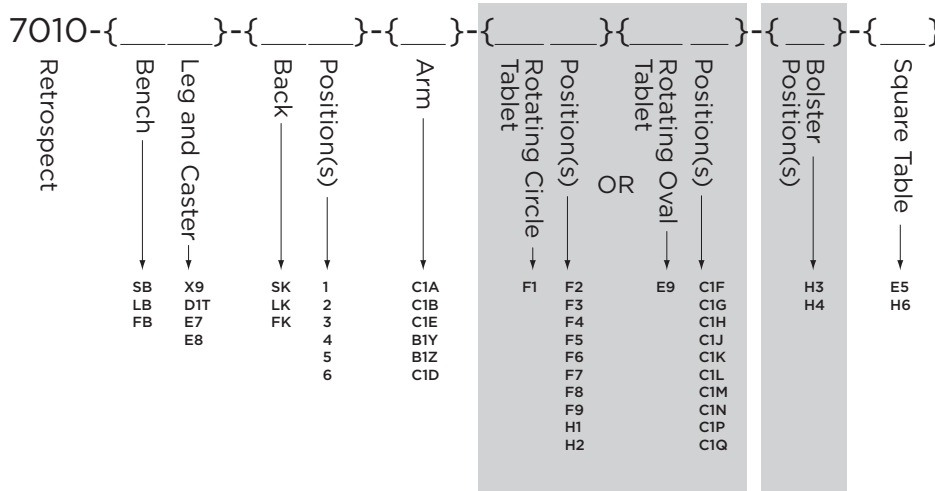

STEP-BY-STEP ORDERING
START WITH CORE MODEL #7010-

STEP 1 SELECT BENCH.
(Specify Textile Grade, Vendor, Pattern and Color)
SB= Single Bench, 24"
LB= Loveseat Bench, 48"
FB= Sofa Bench, 72"

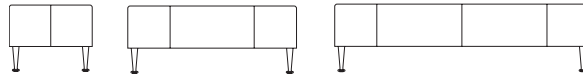

STEP 2 SELECT LEG AND CASTER OPTION.
X9= Satin Aluminum Legs
DIT= Wood (Set of 4) (specify finish)
E7= Casters (Set of 4)
E8= Casters (Set of 2)

STEP 3 SELECT BACK.
(Specify Textile Grade, Vendor, Pattern and Color if different from bench textile)
SK= Single Back, 24"
LK= Loveseat Back, 48"
FK= Sofa Back, 72"



STEP 4 SELECT BACK POSITION.
1= left back
2= center back
3= right back
4= left front
5= center front
6= right front

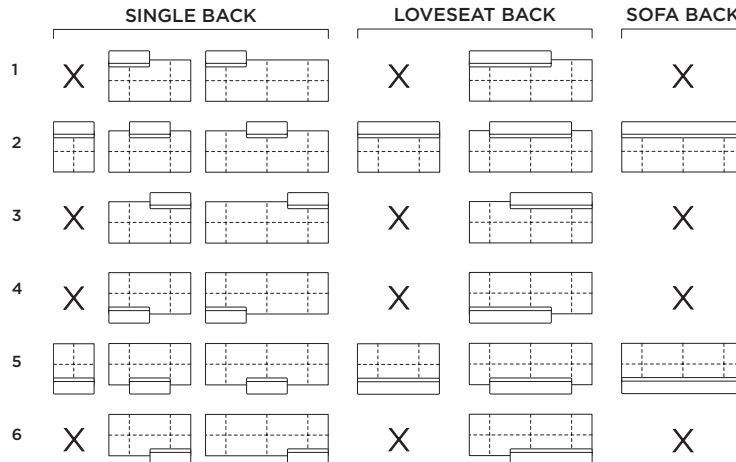

RETROSPECT

STEP 5 SELECT ARM.

(Specify Textile Grade, Vendor, Pattern and Color if different from bench textile)

- C1A= Straight Arm (left side facing)
- C1B= Straight Arm (right side facing)
- C1E= Straight Arms (left and right)
- B1Y= Flared Arm (left side facing)
- B1Z= Flared Arm (right side facing)
- C1D= Flared Arms (left and right)

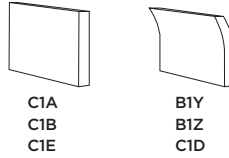

STEP 6 SELECT ROTATING CIRCLE TABLE (F1).

SELECT ROTATING CIRCLE TABLE POSITION.

(Specify finish or HPL)

- F2= Left Back, Long Side
- F3= Center Back, Long Side
- F4= Right Back, Long Side
- F5= Left Front, Long Side
- F6= Center Front, Long Side
- F7= Right Front, Long Side
- F8= Left Back, Short Side
- F9= Right Back, Short Side
- H1= Left Front, Short Side
- H2= Right Front, Short Side

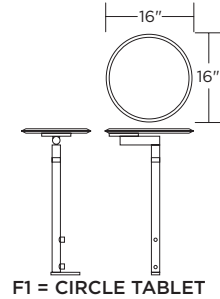
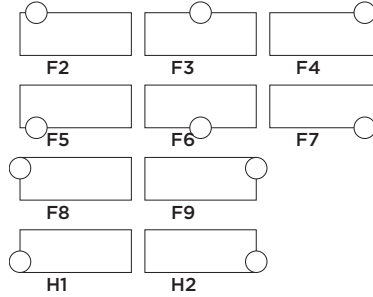

F1 = CIRCLE TABLE

*note: tablet not available in Position F8, F9, H1 or H2 when arms are attached.
*note: tablet not available when backs are positioned in tablet location.

OR SELECT ROTATING OVAL TABLE (E9).

SELECT ROTATING OVAL TABLE POSITION.

(Specify finish or HPL)

- C1F= Left Back, Long Side
- C1G= Center Back, Long Side
- C1H= Right Back, Long Side
- C1J= Left Front, Long Side
- C1K= Center Front, Long Side
- C1L= Right Front, Long Side
- C1M= Left Back, Short Side
- C1N= Right Back, Short Side
- C1P= Left Front, Short Side
- C1Q= Right Front, Short Side

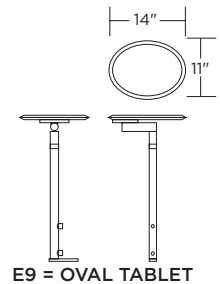
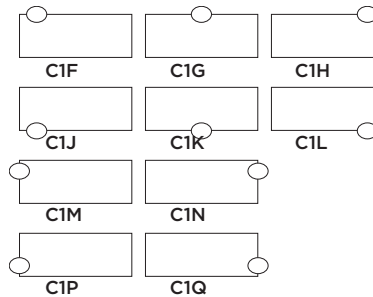

E9 = OVAL TABLE

*note: tablet not available in Position C1M, C1N, C1P or C1Q when arms are attached.
*note: tablet not available when backs are positioned in tablet location.

STEP 7 SELECT BOLSTER(S) AND POSITION.

- H3= Left Bolster
- H4= Right Bolster
- C1C= Pair of Bolsters



STEP 8 SELECT SQUARE TABLE.

(Specify base finish and top finish, HPL solid surface or glass)
H5= Table Ganging—No Legs for placement in between benches
H6= Table End—Has 2 Legs for end placement

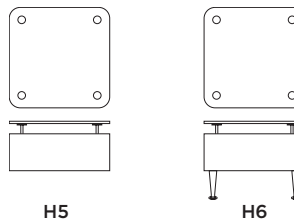

EXAMPLE:

- 7010-LB-X9-LK2-C1E-F1-F5-MNW-C1C-H6-MNW-X9
- 5/Momentum, Row, Breeze (Bench and Back)
- 4/Momentum, Canter, Sand (Bolsters)
- 7010» Retrospect Series
- LB» Loveseat Bench (5/Momentum, Row, Breeze)
- X9» Satin Aluminum Legs
- LK2» Loveseat Back, Center Position
- C1E» Pair of Straight Arms (leg and right facing)
- F1-F5-MNW» Round Tablet, Left Front - Long Side Position
- C1C» Pair of Bolsters (4/Momentum, Canter, Sand)
- H6-MNW-X9» Square Table

RETROSPECT BENCH STANDARD FEATURES

- Armless
- Upholstered Seat
- Tight Cushion
- Optional Maple Hardwood Legs (DIT)
- 7" Machine Turned Satin Aluminum Legs
- Non-Marring Adjustable Glides
- NOTE: Floor Plan Required for any Ganging Configurations
- E7 and E8 Casters:
- Caster Machine Turned Satin Aluminum with Andonized Finish with Black Rotating Dual Wheel

SINGLE BENCH



w	outside d	h	sw	seat sd	sh	seat to top of back	arm height	weight lbs.	cubic feet
24	24	19	n/a	n/a	n/a	n/a	n/a	20	13

model	yds com (54")	sq ft col	com 1	col 2	3	4	5	6	7	8	9	10	11	12	13	14	15	L1	L2	L3
7010-SB	1.5	n/a	882	907	935	970	1,020	1,090	1,161	1,231	1,302	1,372	1,443	1,513	1,584	1,654	1,725	1,202	1,274	1,343

LOVESEAT BENCH



w	outside d	h	sw	seat sd	sh	seat to top of back	arm height	weight lbs.	cubic feet
48	24	19	n/a	n/a	n/a	n/a	n/a	40	22

model	yds com (54")	sq ft col	com 1	col 2	3	4	5	6	7	8	9	10	11	12	13	14	15	L1	L2	L3
7010-LB	2.25	n/a	1,220	1,257	1,299	1,352	1,426	1,532	1,638	1,744	1,850	1,955	2,061	2,167	2,273	2,379	2,484	1,687	1,793	1,898

SOFA BENCH

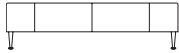

w	outside d	h	sw	seat sd	sh	seat to top of back	arm height	weight lbs.	cubic feet
72	24	19	n/a	n/a	n/a	n/a	n/a	60	31

model	yds com (54")	sq ft col	com 1	col 2	3	4	5	6	7	8	9	10	11	12	13	14	15	L1	L2	L3
7010-FB	3	n/a	1,577	1,626	1,683	1,753	1,852	1,993	2,134	2,275	2,416	2,557	2,699	2,840	2,981	3,122	3,263	2,190	2,332	2,472

OPTIONS

Leg and Caster	Ganging Devices	Fabric 1
Standard X9 Satin Aluminum Legs	Standard X9 No Selection of Option	Selection Required
DIT Wood (set of 4) (specify finish) \$122 E7 Caster Legs (set of 4) \$122 E8 Caster Legs (set of 2) and two standard legs \$61	C4 (set of 2) \$59	Fabric: Grade, Vendor, Pattern, Color NOTE: For multiple fabric applications see page 14 for information and pricing

HOW TO ORDER

SPECIFY: Leg and caster | leg finish (if applicable) | textile pattern and color. See pages 5-14 for information and options on moisture barrier, CAL133, upholstery applications, a complete offering of finishes and ordering details.

MODEL NUMBER

7010-SB

Leg and Caster	Ganging Devices	Fabric 1
DIT - MLC	C4	Grade 5, Momentum, Row, Breeze

RETROSPECT BACK ORDERING STANDARD FEATURES

- Upholstered Back Panel
- Attaches to Outside of Seat Cushion
- Must Specify Back Position
- NOTE: Floor Plan Required for any Ganging Configurations

SINGLE BACK

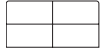

w	outside			sw	seat			seat to top of back	arm height	weight lbs.	cubic feet
	d	h			sd	sh					
24	5	15		n/a	n/a	n/a	n/a	n/a	n/a	40	n/a

model	yds com (54")	sq ft col	com 1	col 2	3	4	5	6	7	8	9	10	11	12	13	14	15	L1	L2	L3
SK	1.5	n/a	489	514	542	577	627	697	768	838	909	979	1,050	1,120	1,191	1,261	1,332	809	881	950

LOVESEAT BACK



w	outside			sw	seat			seat to top of back	arm height	weight lbs.	cubic feet
	d	h			sd	sh					
48	5	15		n/a	n/a	n/a	n/a	n/a	n/a	50	n/a

model	yds com (54")	sq ft col	com 1	col 2	3	4	5	6	7	8	9	10	11	12	13	14	15	L1	L2	L3
LK	2.25	n/a	735	772	814	867	941	1,047	1,153	1,259	1,365	1,470	1,576	1,682	1,788	1,894	1,999	1,202	1,308	1,413

SOFA BACK

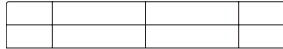

w	outside			sw	seat			seat to top of back	arm height	weight lbs.	cubic feet
	d	h			sd	sh					
72	5	15		n/a	n/a	n/a	n/a	n/a	n/a	60	n/a

model	yds com (54")	sq ft col	com 1	col 2	3	4	5	6	7	8	9	10	11	12	13	14	15	L1	L2	L3
FK	3	n/a	1,077	1,126	1,183	1,253	1,352	1,493	1,634	1,775	1,916	2,057	2,199	2,340	2,481	2,622	2,763	1,690	1,832	1,972

OPTIONS

Back Position	Fabric 1
Selection Required	Selection Required
1 Left Back 2 Center Back 3 Right Back 4 Left Front 5 Center Front 6 Right Front	Fabric: Grade, Vendor, Pattern, Color NOTE: For multiple fabric applications see page 14 for information and pricing

HOW TO ORDER

SPECIFY: Back position | textile pattern and color. See pages 5-14 for information and options on moisture barrier, CAL133, upholstery applications, a complete offering of finishes and ordering details.

MODEL NUMBER

SK

Back Position	Fabric 1
1	Grade 5, Momentum, Row, Breeze

RETROSPECT ARM ORDERING STANDARD FEATURES

- Upholstered Arm Panel
- Straight Arm or Flared Arm
- Attaches to Outside of Seat Cushion
- Must Specify Back Position
- NOTE: Arms have to Connect to a Back; Back must be Specified if Arms are Specified
- NOTE: Floor Plan Required for any Ganging Configurations

STRAIGHT ARM



model		w	d	h	wt	cu ft
C1A	LEFT SIDE FACING	2	29	20	n/a	n/a
C1B	RIGHT SIDE FACING	2	29	20	n/a	n/a
C1E	PAIR OF ARMS, LEFT AND RIGHT	2	29	20	n/a	n/a

yds com (54")	sq ft col	com 1	col 2	3	4	5	6	7	8	9	10	11	12	13	14	15	L1	L2	L3
1 per arm	n/a	129	145	164	188	221	268	315	362	409	456	503	550	597	644	691	352	399	446

FLARE UPHOLSTERED ARM



model		w	d	h	wt	cu ft
B1Y	LEFT SIDE FACING	2	29	20	n/a	n/a
B1Z	RIGHT SIDE FACING	2	29	20	n/a	n/a
C1D	PAIR OF ARMS, LEFT AND RIGHT	2	29	20	n/a	n/a

yds com (54")	sq ft col	com 1	col 2	3	4	5	6	7	8	9	10	11	12	13	14	15	L1	L2	L3
1 per arm	n/a	129	145	164	188	221	268	315	362	409	456	503	550	597	644	691	352	399	446

OPTIONS

Arm Position	Fabric 1
Selection Required	Selection Required
C1A Straight Arm (Left Side Facing) C1B Straight Arm (Right Side Facing) C1E Straight Arms (Left and Right) B1Y Flared Arm (Left Side Facing) B1Z Flared Arm (Right Side Facing) C1D Flared Arms (Left and Right)	Fabric: Grade, Vendor, Pattern, Color NOTE: For multiple fabric applications see page 14 for information and pricing

HOW TO ORDER

SPECIFY: Arm position | textile pattern and color. See pages 5-14 for information and options on moisture barrier, CAL133, upholstery applications, a complete offering of finishes and ordering details.

MODEL NUMBER

C1A

Arm Position	Fabric 1
C1A	Grade 5, Momentum, Row, Breeze

RETROSPECT TABLET STANDARD FEATURES

- Tablet Arm Aluminum with Anodized Finish
- Tablet Top Options - Veneer w/ Exposed Edge or HPL with Exposed Edge
- NOTE: Floor Plan Required for any Ganging Configurations

ROTATING CIRCLE TABLET

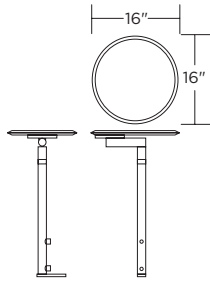

model	dia	w	d	h	wt	cu ft	list
F1	16	n/a	n/a	n/a	10	n/a	\$ 632

ROTATING OVAL TABLET

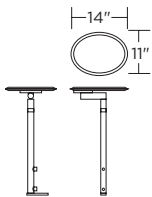

model	w	d	h	wt	cu ft	list
E9	14	11	n/a	10	n/a	\$ 632

OPTIONS

Tablet Position	Top Material
Selection Required	Selection Required
F1 Retrospect Rotating Circle Tablet Positioning: F2 Left Back, Long Side F3 Center Back, Long Side F4 Right Back, Long Side F5 Left Front, Long Side F6 Center Front, Long Side F7 Right Front, Long Side F8 Left Back, Short Side F9 Right Back, Short Side H1 Left Front, Short Side H2 Right Front, Short Side E9 Retrospect Rotating Oval Tablet Positioning: C1F Left Back, Long Side C1G Center Back, Long Side C1H Right Back, Long Side C1J Left Front, Long Side C1K Center Front, Long Side C1L Right Front, Long Side C1M Left Back, Short Side C1N Right Back, Short Side C1P Left Front, Short Side C1Q Right Front, Short Side	Veneer (Stain Matched Edge) HPL (Stain Matched Edge) See pages 9-10 for full list of finish and HPL options

HOW TO ORDER

SPECIFY: Tablet position | Top material - Veneer or HPL. See pages 5-14 for a complete offering of finishes and ordering details.

MODEL NUMBER

F1

Tablet Position	Top Material
C1A	MNW

RETROSPECT GANGING TABLE STANDARD FEATURES

- Top Options - Maple Veneer or HPL with Stain Matched Edge, Glass or Solid Surface
- 7" Machine Turned Satin Aluminum Legs
- Non-Marring Adjustable Glides
- H5 Ganging Table without Legs for Middle of Run; Cannot Gang in 45 or 9 Degree Configurations
- H6 End Table with Two Legs for End of Run
- H5 and H6 Cannot Gang to Bench with an Arm
- NOTE: Floor Plan Required for any Ganging Configurations

TABLE GANGING

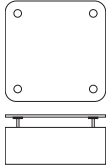

model	w	d	h	wt	cu ft	list
H5	24	24	17.5	40	20	\$ 1,556

TABLE END

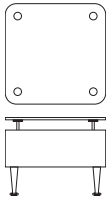

model	w	d	h	wt	cu ft	list
H6	24	24	17.5	40	20	\$ 1,709

OPTIONS

Base Finish	Floating Top
Selection Required	Standard
See page 9 for full list of finish options	X9 Veneer Match to Base HPL (Matching PVC Edge) Solid Surface GLS White Back Painted Tempered Mint Green Glass CG1 Tempered Mint Green Glass FGL Frosted Tempered Glass See pages 9-10 for full list of finish, HPL and Solid Surface options

HOW TO ORDER

SPECIFY: Base finish | Top material - Veneer, HPL, solid surface or glass. See pages 5-14 for a complete offering of finishes and ordering details.

MODEL NUMBER

H5

Base Finish	Floating Top
MNW	GLS

RETROSPECT STANDARD FEATURES

- Poly-Fill
- Hidden Zipper
- Bolsters come Standard with D-Ring Attachment
- NOTE: Floor Plan Required for any Ganging Configurations

ARM BOLSTER



model		w	d	h	wt	cu ft
H3	LEFT SIDE FACING	6	19	6	n/a	n/a
H4	RIGHT SIDE FACING	6	19	6	n/a	n/a
C1C	PAIR OF BOLSTERS	6	19	6	n/a	n/a

yds com (54")	sq ft col	com 1	col 2	3	4	5	6	7	8	9	10	11	12	13	14	15	L1	L2	L3
1 per bolster 1 per pair	n/a	175	191	210	234	267	314	361	408	455	502	549	596	643	690	737	398	445	492

OPTIONS

Fabric 1

Selection Required

Fabric: Grade, Vendor, Pattern, Color

NOTE: For multiple fabric applications see page 14 for information and pricing

HOW TO ORDER

SPECIFY: Textile pattern and color. See pages 5-14 for information and options on moisture barrier, CAL133, upholstery applications, a complete offering of finishes and ordering details.

MODEL NUMBER

H3

Fabric 1

Grade 5, Momentum, Row, Breeze

HUG GUEST STANDARD FEATURES

- Upholstered Seat and Back
- Clean-Thru Design
- Detailed Seams
- European Beech Frame
- Wall-Saver Design
- Non-Marring Adjustable Glides

GUEST CHAIR

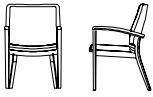

w	outside			sw	seat			seat to top of back	arm height	weight lbs.	cubic feet
	d	h			sd	sh					
24	26	36.5		20	19	19	17.5	27	24.5	18	

model	yds com (54")	sq ft col	com 1	col 2	3	4	5	6	7	8	9	10	11	12	13	14	15	L1	L2	L3
1215	1.5	n/a	1,012	1,037	1,065	1,100	1,150	1,220	1,291	1,361	1,432	1,502	1,573	1,643	1,714	1,784	1,855	1,332	1,404	1,473

OPTIONS

Finish	Arm Cap	Fabric 1	Fabric 2
Selection Required	Standard X9 No Arm Cap	Selection Required	Selection Required
See page 9 for full list of finish options	Resin \$52 pair DIN Black D1M Taupe D1P Grey Solid Surface \$485 pair CWS Cameo White MWS Modern White CSS Concrete DMS Deep Mink	Fabric: Grade, Vendor, Pattern, Color	Fabric: Grade, Vendor, Pattern, Color NOTE: For multiple fabric application see page 14 for information and pricing.

HOW TO ORDER

SPECIFY: Finish | Arm Cap | Textile pattern and color. See pages 5-14 for information and options on moisture barrier, CAL133, upholstery applications, a complete offering of finishes and ordering details

MODEL NUMBER

1215

Finish	Arm Cap	Fabric 1	Fabric 2
MNW	X9	Grade 5, Momentum, Row, Breeze	Grade 5, Momentum, Row, Breeze

INTERLUDE GUEST STANDARD FEATURES

- Clean-Thru Design
- Upholstered Seat and Back
- Upholstered Arm Panel with European Beech Arm Cap Standard on 1922
- European Beech Open Arm Frame with Arm Cap Standard on 1922OA
- Wallsaver Design
- Legs made of 1 x 2 16 Gauge Tubing (.06" Wall Thickness)
- Field Replaceable Components
- Eurolux® with SilverBan® on all Exposed Wood as specified
- Non-Marring Adjustable Glides

UPHOLSTERED BACK W/ UPHOLSTERED ARM PANELS, GUEST CHAIR



w	outside d	h	sw	seat sd	sh	seat to top of back	arm height	weight lbs.	cubic feet
25	24.5	36.75	20.5	18	19	17.75	25.5	35	27

model	yds com (54")	sq ft col	com 1	col 2	3	4	5	6	7	8	9	10	11	12	13	14	15	L1	L2	L3
1922	2.25	n/a	1,624	1,661	1,703	1,756	1,830	1,936	2,042	2,148	2,254	2,359	2,465	2,571	2,677	2,783	2,888	2,091	2,197	2,302

UPHOLSTERED BACK W/ OPEN ARMS GUEST CHAIR

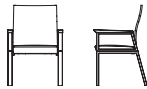

w	outside d	h	sw	seat sd	sh	seat to top of back	arm height	weight lbs.	cubic feet
25	24.5	36.75	20.5	18	19	17.75	25.5	35	27

model	yds com (54")	sq ft col	com 1	col 2	3	4	5	6	7	8	9	10	11	12	13	14	15	L1	L2	L3
1922OA	1.5	n/a	1,649	1,674	1,702	1,737	1,787	1,857	1,928	1,998	2,069	2,139	2,210	2,280	2,351	2,421	2,492	1,969	2,041	2,110

OPTIONS

Arm Caps	Finish	Powder Coat	Removable Covers	Fabric 1
Standard X3 Wood	Standard X9 No Selection of Option	Selection Required	Standard X9 No Selection of Option	Selection Required
A4 Poly (black) \$231 pair	See page 9 for full list of finish options NOTE: Select finish when 1922OA model or A3 wood arm cap option is specified	BWT Bone White BUFF Buff CHLK Chalk SGLD Gold GRPH Graphite MSL Luster Grey HIP Oiled Bronze BKO Onyx POLR Polar SBRZ Soft Bronze HIF Warm Grey	H7 Removable Seat and Back Covers \$196 B1L Removable Seat Cover only \$98 B1M Removable Back Cover only \$98	Fabric: Grade, Vendor, Pattern, Color NOTE: For multiple fabric applications see page 14 for information and pricing

HOW TO ORDER

SPECIFY: Arm caps | wood finish (if applicable) | powder coat | removable covers | textile pattern and color. See pages 5-14 for information and options on moisture barrier, CAL133, upholstery applications, a complete offering of finishes and ordering details.

MODEL NUMBER

1922

Arm Caps	Finish	Powder Coat	Removable Covers	Fabric 1
A3	MLC	BWT	H7	Grade 5, Momentum, Row, Breeze

GUEST/STACKING CHAIR STANDARD FEATURES

- Armless
- Stacks Four High on the Floor
- Nylon Glides

• All Styles Rated up to 300 lbs.
SHIPPING NOTE: Chairs are packed three to a carton.
Order quantities not divisible by three are subject to a carton breakage charge of \$30 list per order.

NOTE: Weight based on three chairs.

PLASTIC PERFORATED BACK



	w	outside d	h	sw	seat sd	sh	inside back	arm height	from floor	weight lbs.	cubic feet
plastic	19.75	21	30.75	18.25	17	16	15.25	n/a	n/a	48	14.5
uph.	19.75	21	30.75	18.25	17	16.75	15.25	n/a	n/a	48	14.5

model	yds com (54")	sq ft col	com 1	col 2	3	4	5	6	7	8	9	10	11	12	13	14	15	L1	L2	L3
C1512	1	12	302	318	337	361	394	441	488	535	582	629	676	723	770	817	864	525	572	619

list

Plastic Seat and Back

\$ 270

PLASTIC SOLID BACK



	w	outside d	h	sw	seat sd	sh	inside back	arm height	from floor	weight lbs.	cubic feet
plastic	19.75	21	30.75	18.25	17	16	15.25	n/a	n/a	48	14.5
uph.	19.75	21	30.75	18.25	17	16.75	15.25	n/a	n/a	48	14.5

model	yds com (54")	sq ft col	com 1	col 2	3	4	5	6	7	8	9	10	11	12	13	14	15	L1	L2	L3
C1512SL	1	12	302	318	337	361	394	441	488	535	582	629	676	723	770	817	864	525	572	619

list

Plastic Seat and Back

\$ 270

UPHOLSTERED BACK AND SEAT



w	outside d	h	sw	seat sd	sh	inside back	arm height	from floor	weight lbs.	cubic feet
19.75	21	30.75	18.25	17	16.75	15.25	n/a	n/a	51	14.5

model	yds com (54")	sq ft col	com 1	col 2	3	4	5	6	7	8	9	10	11	12	13	14	15	L1	L2	L3
C1512UB	1	24	364	380	399	423	456	503	550	597	644	691	738	785	832	879	926	587	634	681

OPTIONS

Frame	Ganging Device	Plastic	Seat Material (C1512 and C1512SL only)	Fabric/Grade
BF Black SF Silver	X9 None - Standard GD8 Ganging Device (1 Pair Per Chair) \$30	DPB Deep Blue PIT Pitch PLT Platinum SNO Snow NOTE: Plastic back and seat color will match.	Plastic Upholstered	X9 None Grade, Vendor, Pattern, Color NOTE: For multiple fabric applications see page 14 for information and pricing.

HOW TO ORDER

SPECIFY: Frame | ganging device | plastic | seat material | textile pattern and color.
See pages 5-14 for information and options on moisture barrier, CAL133, upholstery applications.

MODEL NUMBER

C1512

Frame	Ganging Device	Plastic	Seat Material (C1512 and C1512SL only)	Fabric/Grade
BF	X9	PIT	Upholstered	Grade 3, Momentum, Hue, Smoke

GUEST/STACKING CHAIR STANDARD FEATURES

- Fixed Arms
- Stacks Four High on the Floor
- Nylon Glides

• All Styles Rated up to 300 lbs.
SHIPPING NOTE: Chairs are packed three to a carton.
Order quantities not divisible by three are subject to a carton breakage charge of \$30 list per order.

NOTE: Weight based on three chairs.

PLASTIC PERFORATED BACK

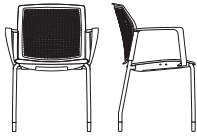

	w	outside d	h	sw	seat sd	sh	inside back	arm height	from floor	weight lbs.	cubic feet
plastic	23.25	21	30.75	18.25	17	16	15.25	7.5	26	53	14.5
uph.	23.25	21	30.75	18.25	17	16.75	15.25	7.5	26	53	14.5

model	yds com (54")	sq ft col	com 1	col 2	3	4	5	6	7	8	9	10	11	12	13	14	15	L1	L2	L3
C1509	1	12	329	345	364	388	421	468	515	562	609	656	703	750	797	844	891	552	599	646

list

Plastic Seat and Back

\$ 297

PLASTIC SOLID BACK

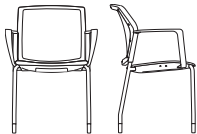

	w	outside d	h	sw	seat sd	sh	inside back	arm height	from floor	weight lbs.	cubic feet
plastic	23.25	21	30.75	18.25	17	16	15.25	7.5	26	53	14.5
uph.	23.25	21	30.75	18.25	17	16.75	15.25	7.5	26	53	14.5

model	yds com (54")	sq ft col	com 1	col 2	3	4	5	6	7	8	9	10	11	12	13	14	15	L1	L2	L3
C1509SL	1	12	329	345	364	388	421	468	515	562	609	656	703	750	797	844	891	552	599	646

list

Plastic Seat

\$ 297

UPHOLSTERED BACK AND SEAT

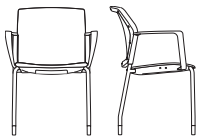

w	outside d	h	sw	seat sd	sh	inside back	arm height	from floor	weight lbs.	cubic feet
23.25	21	30.75	18.25	17	16.75	15.25	7.5	26	56	14.5

model	yds com (54")	sq ft col	com 1	col 2	3	4	5	6	7	8	9	10	11	12	13	14	15	L1	L2	L3
C1509UB	1	24	391	407	426	450	483	530	577	624	671	718	765	812	859	906	953	614	661	708

OPTIONS

Frame	Ganging Device	Plastic	Seat Material (C1509 and C1509SL only)	Fabric/Grade
BF Black SF Silver	X9 None - Standard GDB Ganging Device (1 Pair Per Chair) \$30	DPB Deep Blue PIT Pitch PLT Platinum SNO Snow NOTE: Plastic back, arms and seat color will match.	Plastic Upholstered	Grade, Vendor, Pattern, Color NOTE: For multiple fabric applications see page 14 for information and pricing

HOW TO ORDER
SPECIFY: Frame | ganging device | plastic | seat material | textile pattern and color.
See pages 5-14 for information and options on moisture barrier, CAL133, upholstery applications.

MODEL NUMBER				
C1509				
Frame	Ganging Device	Plastic	Seat Material (C1509 and C1509SL only)	Fabric/Grade
BF	X9	DPB	Upholstered	Grade 3, Momentum, Hue, Smoke

GUEST/STACKING CHAIR STANDARD FEATURES

- Armless
- Hard Wheel Casters
- All Styles Rated up to 300 lbs.

SHIPPING NOTE: Chairs are packed three to a carton. Order quantities not divisible by three are subject to a carton breakage charge of \$30 list per order.

NOTE: Weight based on three chairs.

PLASTIC PERFORATED BACK

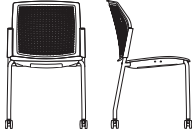

	w	outside d	h	sw	seat sd	sh	inside back	arm height	from floor	weight lbs.	cubic feet
plastic	19.75	21	30.75	18.25	17	16	15.25	n/a	n/a	50	14.5
uph.	19.75	21	30.75	18.25	17	16.75	15.25	n/a	n/a	50	14.5

model	yds com (54")	sq ft col	com 1	col 2	3	4	5	6	7	8	9	10	11	12	13	14	15	L1	L2	L3
C1522	1	12	333	349	368	392	425	472	519	566	613	660	707	754	801	848	895	556	603	650

list

Plastic Seat and Back

\$ 302

PLASTIC SOLID BACK

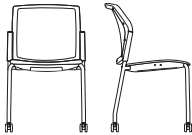

	w	outside d	h	sw	seat sd	sh	inside back	arm height	from floor	weight lbs.	cubic feet
plastic	19.75	21	30.75	18.25	17	16	15.25	n/a	n/a	50	14.5
uph.	19.75	21	30.75	18.25	17	16.75	15.25	n/a	n/a	50	14.5

model	yds com (54")	sq ft col	com 1	col 2	3	4	5	6	7	8	9	10	11	12	13	14	15	L1	L2	L3
C1522SL	1	12	333	349	368	392	425	472	519	566	613	660	707	754	801	848	895	556	603	650

list

Plastic Seat and Back

\$ 302

UPHOLSTERED BACK AND SEAT

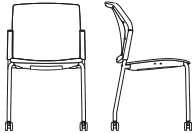

w	outside d	h	sw	seat sd	sh	inside back	arm height	from floor	weight lbs.	cubic feet
19.75	21	30.75	18.25	17	16.75	15.25	n/a	n/a	53	14.5

model	yds com (54")	sq ft col	com 1	col 2	3	4	5	6	7	8	9	10	11	12	13	14	15	L1	L2	L3
C1522UB	1	24	395	411	430	454	487	534	581	628	675	722	769	816	863	910	957	618	665	712

OPTIONS

Frame	Casters	Ganging Device	Plastic	Seat Material (C1522 and C1522SL only)	Fabric/Grade
BF Black SF Silver	W48 Hard Wheel Casters - Standard W49 Soft Wheel Casters \$30	X9 None - Standard GD8 Ganging Device (1 Pair Per Chair) \$30	DPB Deep Blue PIT Pitch PLT Platinum SNO Snow NOTE: Plastic back and seat color will match.	Plastic Upholstered	Grade, Vendor, Pattern, Color NOTE: For multiple fabric applications see page 14 for information and pricing

HOW TO ORDER
SPECIFY: Frame | casters | ganging device | plastic | seat material | textile pattern and color.
See pages 5-14 for information and options on moisture barrier, CAL133, upholstery applications.

MODEL NUMBER					
C1522					
Frame	Casters	Ganging Device	Plastic	Seat Material (C1522 and C1522SL only)	Fabric/Grade
BF	W48	X9	DPB	Upholstered	Grade 3, Momentum, Hue, Smoke

GUEST/STACKING CHAIR STANDARD FEATURES

- Fixed Arms
- Hard Wheel Casters
- All Styles Rated up to 300 lbs.

SHIPPING NOTE: Chairs are packed three to a carton. Order quantities not divisible by three are subject to a carton breakage charge of \$30 list per order.

NOTE: Weight based on three chairs.

PLASTIC PERFORATED BACK

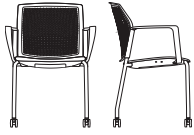

	w	outside d	h	sw	seat sd	sh	inside back	arm height	from floor	weight lbs.	cubic feet
plastic	23.25	21	30.75	18.25	17	16	15.25	7.5	26	56	14.5
uph.	23.25	21	30.75	18.25	17	16.75	15.25	7.5	26	56	14.5

model	yds com (54")	sq ft col	com 1	col 2	3	4	5	6	7	8	9	10	11	12	13	14	15	L1	L2	L3
C1529	1	12	360	376	395	419	452	499	546	593	640	687	734	781	828	875	922	583	630	677

list

Plastic Seat and Back

\$ 329

PLASTIC SOLID BACK

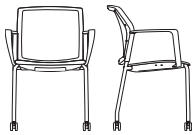

	w	outside d	h	sw	seat sd	sh	inside back	arm height	from floor	weight lbs.	cubic feet
plastic	23.25	21	30.75	18.25	17	16	15.25	7.5	26	56	14.5
uph.	23.25	21	30.75	18.25	17	16.75	15.25	7.5	26	56	14.5

model	yds com (54")	sq ft col	com 1	col 2	3	4	5	6	7	8	9	10	11	12	13	14	15	L1	L2	L3
C1529SL	1	12	360	376	395	419	452	499	546	593	640	687	734	781	828	875	922	583	630	677

list

Plastic Seat

\$ 329

UPHOLSTERED BACK AND SEAT

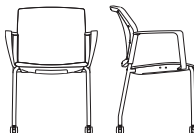

w	outside d	h	sw	seat sd	sh	inside back	arm height	from floor	weight lbs.	cubic feet
23.25	21	30.75	18.25	17	16.75	15.25	7.5	26	56	14.5

model	yds com (54")	sq ft col	com 1	col 2	3	4	5	6	7	8	9	10	11	12	13	14	15	L1	L2	L3
C1529UB	1	24	422	438	457	481	514	561	608	655	702	749	796	843	890	937	984	645	692	739

OPTIONS

Frame	Casters	Ganging Device	Plastic	Seat Material (C1529 and C1529SL only)	Fabric/Grade
BF Black SF Silver	W48 Hard Wheel Casters - Standard W49 Soft Wheel Casters \$30	X9 None - Standard GD8 Ganging Device (1 Pair Per Chair) \$30	DPB Deep Blue PIT Pitch PLT Platinum SNO Snow NOTE: Plastic back, arms and seat color will match.	Plastic Upholstered	Grade, Vendor, Pattern, Color NOTE: For multiple fabric applications see page 14 for information and pricing

HOW TO ORDER
SPECIFY: Frame | casters | ganging device | plastic | seat material | textile pattern and color.
See pages 5-14 for information and options on moisture barrier, CAL133, upholstery applications.

MODEL NUMBER					
C1529					
Frame	Casters	Ganging Device	Plastic	Seat Material (C1529 and C1529SL only)	Fabric/Grade
BF	W48	X9	DPB	Upholstered	Grade 3, Momentum, Hue, Smoke

GUEST/STACKING CHAIR STANDARD FEATURES

- Fully Upholstered Seat and Back
- Nylon Glides
- Wall-Saver Frame
- Stacks Four High on the Floor
- Clean-Thru Design
- All Styles Rated up to 300 lbs.

NOTE: Optional Dolly and Ganging Device sold on page 278.

ARMLESS GUEST CHAIR

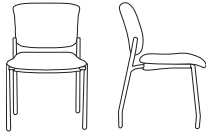

w	outside d	h	sw	seat sd	sh	inside back	arm height	from floor	weight lbs.	cubic feet
21.5	24	33	16.5	18.25	18	14.5	n/a	n/a	25	16

- Armless

model	yds com (54")	sq ft col	com 1	col 2	3	4	5	6	7	8	9	10	11	12	13	14	15	L1	L2	L3
C2012	1.5	30	411	436	464	499	549	619	690	760	831	901	972	1,042	1,113	1,183	1,254	731	803	872

GUEST CHAIR

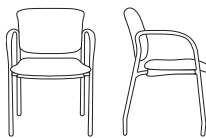



w	outside d	h	sw	seat sd	sh	inside back	arm height	from floor	weight lbs.	cubic feet
24	24	33	16.5	18.25	18	14.5	n/a	n/a	n/a	16
							fixed black arms (BA)	8.5	27.5	28
							fixed silver arms (SA)	8.5	27.5	28

- Fixed Arms

model	yds com (54")	sq ft col	com 1	col 2	3	4	5	6	7	8	9	10	11	12	13	14	15	L1	L2	L3
C2009	1.5	30	485	510	538	573	623	693	764	834	905	975	1,046	1,116	1,187	1,257	1,328	805	877	946

OPTIONS

Frame	Arms (C2009 Only)	Glides	Tablet (2012 Only)	Book Rack	Seat Foam	Fabric 1	Fabric 2
BF Black SF Silver	 BA Fixed Black Arms - Standard  SA Fixed Silver Arms \$32	W26 High Glides - Standard W34 Silver High Glides \$32	X9 None - Standard TR1 Right Hand Seated \$127 TL1 Left Hand Seated \$127 NOTE: Available on armless chairs only and are non-stackable with tablet.	X9 None - Standard BR1 Book Rack \$79	X9 None - Standard AF1 1" Additional Seat Foam \$41 NOTE: Add additional 10% for COM.	Grade, Vendor, Pattern, Color	Grade, Vendor, Pattern, Color

HOW TO ORDER

SPECIFY: Frame | arms | glides | tablet | book rack | seat foam | fabric 1 | fabric 2
 See pages 5-14 for information and options on moisture barrier, CAL133, upholstery applications.

MODEL NUMBER

C2012

Frame	Arms	Glides	Tablet (2012 Only)	Book Rack	Seat Foam	Fabric 1	Fabric 2
BF	BA	W26	X9	X9	X9	Grade 3, Momentum, Hue, Smoke	Grade 3, Momentum, Epic, Limestone

GUEST/STACKING CHAIR STANDARD FEATURES

- Fully Upholstered Seat and Back
- Hard Wheel Casters
- Wall-Saver Legs
- Clean-Thru Design
- All Styles Rated up to 300 lbs.

NOTE: Optional Dolly and Ganging Device sold on page 278.

GUEST/STACKING

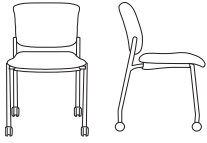

w	outside d	h	sw	seat sd	sh	inside back	arm height	from floor	weight lbs.	cubic feet
21.5	24	33	16.5	18.25	18	14.5	n/a	n/a	25	16

- Armless

model	yds com (54")	sq ft col	com 1	col 2	3	4	5	6	7	8	9	10	11	12	13	14	15	L1	L2	L3
C2212	1.5	30	451	476	504	539	589	659	730	800	871	941	1,012	1,082	1,153	1,223	1,294	771	843	912

GUEST CHAIR WITH CASTERS

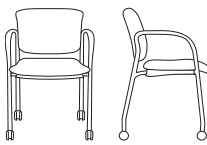

w	outside d	h	sw	seat sd	sh	inside back	arm height	from floor	weight lbs.	cubic feet
24	24	33	16.5	18.25	18	14.5	n/a	n/a	n/a	16

fixed black arms (BA)

8.5	27.5	28	
-----	------	----	--

fixed silver arms (SA)

8.5	27.5	28	
-----	------	----	--

- Fixed Arms

model	yds com (54")	sq ft col	com 1	col 2	3	4	5	6	7	8	9	10	11	12	13	14	15	L1	L2	L3
C2209	1.5	30	525	550	578	613	663	733	804	874	945	1,015	1,086	1,156	1,227	1,297	1,368	845	917	986

OPTIONS

Frame	Arms (C2209 Only)	Casters	Tablet (2212 Only)	Book Rack	Seat Foam	Fabric 1	Fabric 2
BF Black SF Silver	 BA Fixed Black Arms - Standard	W48 Hard Wheel Casters - Standard W15A Hard Wheel Casters with Safety Brake \$32 W16 Soft Wheel Casters with Safety Brake \$32 W49 Soft Wheel Casters \$32	X9 None - Standard TR1 Right Hand Seated \$127 TL1 Left Hand Seated \$127 NOTE: Available on armless chairs only and are non-stackable with tablet.	X9 None - Standard BR1 Book Rack \$79	X9 None - Standard AF1 1" Additional Seat Foam \$41 NOTE: Add additional 10% for COM.	Grade, Vendor, Pattern, Color	Grade, Vendor, Pattern, Color
	 SA Fixed Silver Arms \$32						

HOW TO ORDER

SPECIFY: Frame | arms | casters | tablet | book rack | seat foam | fabric 1 | fabric 2
See pages 5-14 for information and options on moisture barrier, CAL133, upholstery applications.

MODEL NUMBER

C2212

Frame	Arms (C2209 Only)	Casters	Tablet (2212 Only)	Book Rack	Seat Foam	Fabric 1	Fabric/Grade
BF		W48	X9	X9	X9	Grade 3, Momentum, Hue, Smoke	Grade 3, Momentum, Epic, Limestone

GUEST SLED CHAIR STANDARD FEATURES

- Fully Upholstered Seat and Back
- Clean-Thru Design

- Anti-tip Glide on Sled Base
- All Styles Rated up to 300 lbs.

NOTE: Optional Dolly and Ganging Device sold on page 278.

ARMLESS

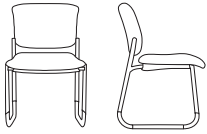

w	outside d	h	sw	seat sd	sh	inside back	arm height	from floor	weight lbs.	cubic feet
21.5	24	33	16.5	18.25	18.5	14.5	n/a	n/a	28	16

- Armless

model	yds com (54")	sq ft col	com 1	col 2	3	4	5	6	7	8	9	10	11	12	13	14	15	L1	L2	L3
C2112	1.5	30	423	448	476	511	561	631	702	772	843	913	984	1,054	1,125	1,195	1,266	743	815	884

ARMS

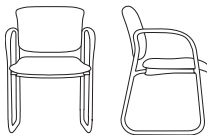



w	outside d	h	sw	seat sd	sh	inside back	arm height	from floor	weight lbs.	cubic feet
24	24	33	16.5	18.25	18.5	14.5	n/a	n/a	n/a	16
							fixed black arms (BA)	8.5	27.5	32
							fixed silver arms (SA)	8.5	27.5	32

- Fixed Arms

model	yds com (54")	sq ft col	com 1	col 2	3	4	5	6	7	8	9	10	11	12	13	14	15	L1	L2	L3
C2109	1.5	30	467	492	520	555	605	675	746	816	887	957	1,028	1,098	1,169	1,239	1,310	787	859	928

OPTIONS

Frame	Arms (C2109 Only)	Book Rack	Seat Foam	Fabric 1	Fabric 2
BF Black SF Silver	 BA Fixed Black Arms - Standard  SA Fixed Silver Arms \$32	X9 None - Standard BR1 Book Rack \$79	X9 None - Standard AF1 1" Additional Seat Foam \$41 NOTE: Add additional 10% for COM.	Grade, Vendor, Pattern, Color	Grade, Vendor, Pattern, Color

HOW TO ORDER

SPECIFY: Frame | arms | book rack | seat foam | fabric 1 | fabric 2
 See pages 5-14 for information and options on moisture barrier, CAL133, upholstery applications.

MODEL NUMBER

C2112

Frame	Arms (C2109 Only)	Book Rack	Seat Foam	Fabric 1	Fabric 2
BF	BA	X9	X9	Grade 3, Momentum, Hue, Smoke	Grade 3, Momentum, Epic, Limestone

HEAVY-DUTY GUEST STANDARD FEATURES

- Fully Upholstered Seat and Back
 - Clean-Thru Design
 - Floor-Saver Swivel Glides
 - Stacks Four High on the Floor
 - Heavy-Duty Rated up to 350 lbs.
- NOTE:** Optional Dolly and Ganging Device sold on page 250.

ARMLESS

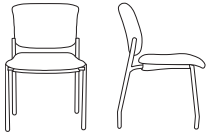

w	outside d	h	sw	seat sd	sh	inside back	arm height	from floor	weight lbs.	cubic feet
21.5	24	33	16.5	18.25	18	14.5	n/a	n/a	25	16

- Armless

model	yds com (54")	sq ft col	com 1	col 2	3	4	5	6	7	8	9	10	11	12	13	14	15	L1	L2	L3
C2412	1.5	30	485	510	538	573	623	693	764	834	905	975	1,046	1,116	1,187	1,257	1,328	805	877	946

ARMS

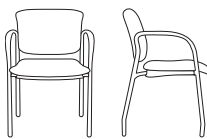



w	outside d	h	sw	seat sd	sh	inside back	arm height	from floor	weight lbs.	cubic feet
24	24	33	16.5	18.25	18	14.5	n/a	n/a	n/a	16
							fixed black arms (BA)	8.5	27.5	28
							fixed silver arms (SA)	8.5	27.5	28

- Fixed Arms

model	yds com (54")	sq ft col	com 1	col 2	3	4	5	6	7	8	9	10	11	12	13	14	15	L1	L2	L3
C2409	1.5	30	559	584	612	647	697	767	838	908	979	1,049	1,120	1,190	1,261	1,331	1,402	879	951	1,020

OPTIONS

Frame	Arms (C2409 Only)	Glides	Fabric 1	Fabric 2
BF Black SF Silver	 BA Fixed Black Arms - Standard  SA Fixed Silver Arms \$32	W37 Floor-Saver Swivel Glides - Standard W38 Felt Tip Swivel Glides \$22	Grade, Vendor, Pattern, Color	Grade, Vendor, Pattern, Color

HOW TO ORDER

SPECIFY: Frame | arms | glides | fabric 1 | fabric 2

See pages 5-14 for information and options on moisture barrier, CAL133, upholstery applications.

MODEL NUMBER

C2412

Frame	Arms (C2409 Only)	Glides	Fabric 1	Fabric 2
BF	BA	W37	Grade 3, Momentum, Hue, Smoke	Grade 3, Momentum, Epic, Limestone

MODERN AMENITY GUEST CHAIR STANDARD FEATURES

- Upholstered Arms, Seat and Back
- Spring Seat Construction
- Clean-Thru Design
- Wall-Saver Design
- Must specify European Beech or American Ash Frame
- Wood Arm Cap
- Non-Marring Adjustable Glides
- Field Replaceable Components
- NOTE: Because of the unique Color of Ash Hardwoods, Stains are a slightly different Color than they appear on the Standard European Beech Hardwoods. If pairing with a Product using Species other than Ash the Stains will appear different. For additional information please contact your Customer Service Representative.

CHAIR, OPEN ARM

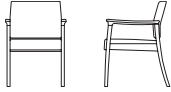

w	outside d	h	sw	seat sd	sh	seat to top of back	arm height	weight lbs.	cubic feet
24	26	34.5	20.75	22.25	19	15	26.75	38	19

model	yds com (54")	sq ft col	com 1	col 2	3	4	5	6	7	8	9	10	11	12	13	14	15	L1	L2	L3
1600	1.5	n/a	1,209	1,234	1,262	1,297	1,347	1,417	1,488	1,558	1,629	1,699	1,770	1,840	1,911	1,981	2,052	1,529	1,601	1,670

CHAIR, PANEL ARM



w	outside d	h	sw	seat sd	sh	seat to top of back	arm height	weight lbs.	cubic feet
24	26	34.5	20.75	22.25	19	15	26.75	42	19

model	yds com (54")	sq ft col	com 1	col 2	3	4	5	6	7	8	9	10	11	12	13	14	15	L1	L2	L3
1610	2.25	n/a	1,308	1,345	1,387	1,440	1,514	1,620	1,726	1,832	1,938	2,043	2,149	2,255	2,361	2,467	2,572	1,775	1,881	1,986

OPTIONS

Wood Species	Arm Caps	Finish	Removable Covers	Fabric 1
Selection Required	Standard A3 Wood	Selection Required	Standard X9 No Selection of Option	Selection Required
A8S European Beech A8T American Ash	Poly \$109 pair D1N Black D1M Taupe D1P Grey Solid Surface \$624 pair CWS Cameo White MWS Modern White CSS Concrete DMS Deep Mink	See page 9 for full list of finish options	H7 Removable Seat and Back Covers \$196 B1L Removable Seat Cover only \$98 B1M Removable Back Cover only \$98	Grade, Vendor, Pattern, Color NOTE: For multiple fabric applications see page 14 for information and pricing

HOW TO ORDER

SPECIFY: Wood species | arm caps | wood finish | removable covers | textile pattern and color. See pages 5-14 for information and options on moisture barrier, CAL133, upholstery applications, a complete offering of finishes and ordering details.

MODEL NUMBER

1600

Wood Species	Arm Caps	Finish	Removable Covers	Fabric 1
A8S	D1N	MLC	H7	Grade 5, Momentum, Row, Breeze

ORCHESTRA GUEST STANDARD FEATURES

- Clean-Thru Design
- Upholstered Seat and Back
- European Beech Open Arm Frame with Wood Arm Cap
- European Beech Exterior Frame
- Wall-Saver Design
- Non-Marring Adjustable Glides
- Field Replaceable Components

GUEST CHAIR



outside			seat			seat to top of back	arm height	weight lbs.	cubic feet
w	d	h	sw	sd	sh				
25	27.5	34	21	19	18	16.5	25.5	40	19

model	yds com (54")	sq ft col	com 1	col 2	3	4	5	6	7	8	9	10	11	12	13	14	15	L1	L2	L3
1408	1.5	n/a	1,240	1,265	1,293	1,328	1,378	1,448	1,519	1,589	1,660	1,730	1,801	1,871	1,942	2,012	2,083	1,560	1,632	1,701

OPTIONS

Arm Caps	Finish	Removable Covers	Fabric 1
Standard X9 No Arm Cap	Selection Required	Standard X9 No Selection of Option	Selection Required
A4 Poly (black) \$185 pair	See page 9 for full list of finish options	H7 Removable Seat and Back Covers \$196 B1L Removable Seat Cover only \$98 B1M Removable Back Cover only \$98	Fabric: Grade, Vendor, Pattern, Color NOTE: For multiple fabric applications see page 14 for information and pricing

HOW TO ORDER

SPECIFY: Arm caps | wood finish | removable covers | textile pattern and color. See pages 5-14 for information and options on moisture barrier, CAL133, upholstery applications, a complete offering of finishes and ordering details.

MODEL NUMBER

1408

Arm Caps	Finish	Removable Covers	Fabric 1
A4	MLC	H7	Grade 5, Momentum, Row, Breeze

GUEST/STACKING STANDARD FEATURES

- Chrome Wall Saver Frame
- Armless
- Stacks 14 High on the Floor (Plastic Seat)
- Stacks 7 High on the Floor (Upholstered Seat)

• All Styles Rated up to 300 lbs.
 SHIPPING NOTE: Chairs are packed four to a carton. Order quantities not divisible by four are subject to a carton breakage charge of \$30 list per order, per chair model upcharge.

NOTE: Weight based on four chairs. Optional Dolly and Ganging Device Available on Page 278.

PLASTIC SEAT AND BACK

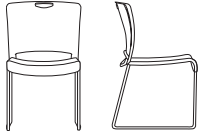

	w	outside d	h	sw	seat sd	sh	inside back	arm height	from floor	weight lbs.	cubic feet
plastic	19	22	32	17.75	18	17.5	16	n/a	n/a	60	15.25
uph.	19	22	32	17.75	18	18	16	n/a	n/a	60	15.25

- Nine plastic colors

model	yds com (54")	sq ft col	com 1	col 2	3	4	5	6	7	8	9	10	11	12	13	14	15	L1	L2	L3
Upholstered Seat with Plastic Back																				
412	1	17.5	275	291	310	334	367	414	461	508	555	602	649	696	743	790	837	498	545	592

list

Plastic Seat and Back

\$ 184

MESH BACK

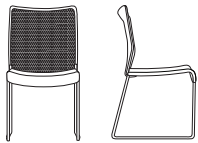

	w	outside d	h	sw	seat sd	sh	inside back	arm height	from floor	weight lbs.	cubic feet
plastic	19	22	31	17.75	18	17.5	15	n/a	n/a	60	15.25
uph.	19	22	31	17.75	18	18	15	n/a	n/a	60	15.25

- Three mesh colors

model	yds com (54")	sq ft col	com 1	col 2	3	4	5	6	7	8	9	10	11	12	13	14	15	L1	L2	L3
Upholstered Seat with Mesh Back																				
412M	1	17.5	331	347	366	390	423	470	517	564	611	658	705	752	799	846	893	554	601	648

list

Plastic Seat

\$ 240

OPTIONS

Glides	Rotating Tablet	Book Rack	Plastic	Mesh Back (412M Only)	Seat Material	Fabric/Grade
X9 None - Standard W23 Clear Nylon Glides (4 Glides Per Set) \$15	X9 None - Standard TR4 Right Hand Seated \$120 TL4 Left Hand Seated \$120 NOTE: Available on armless chairs only and are non-stackable with tablet.	X9 None - Standard BR4 Chrome Book Rack \$65	BAT Battleship BLK Black BRD Bordeaux CHN Chestnut DPB Deep Blue SAG Sage SND Sand SLT Slate WHT White	MBK Black MDG Dark Gray MSL Silver	Plastic Upholstered	X9 None Grade, Vendor, Pattern, Color

HOW TO ORDER

SPECIFY: Glides | rotating tablet | book rack | plastic | mesh back | seat material | textile pattern and color. See pages 5-14 for information and options on moisture barrier, CAL133, upholstery applications.

MODEL NUMBER

412

Glides	Rotating Tablet	Book Rack	Plastic	Mesh Back	Seat Material	Fabric/Grade
X9	X9	X9	BAT		Upholstered	Grade 3, Momentum, Hue, Smoke

GUEST/STACKING STANDARD FEATURES

- Chrome Wall Saver Frame
- Armless
- Stacks 7 High on the Floor
- All Styles Rated up to 300 lbs.

SHIPPING NOTE: Chairs are packed four to a carton. Order quantities not divisible by four are subject to a carton breakage charge of \$30 list per order, per chair model upcharge.

NOTE: Weight based on four chairs. Optional Dolly and Ganging Device Available on Page 278

UPHOLSTERED BACK AND SEAT

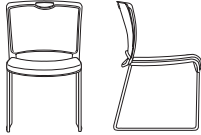

w	outside		sw	seat		inside back	arm height	from floor	weight lbs.	cubic feet
	d	h		sd	sh					
19	22	32	17.75	18	18	16	n/a	n/a	76	15.25

- Black plastic is standard on upholstered seats and backs unless otherwise specified.

model	yds com (54")	sq ft col	com 1	col 2	3	4	5	6	7	8	9	10	11	12	13	14	15	L1	L2	L3
412UB	1	29	368	384	403	427	460	507	554	601	648	695	742	789	836	883	930	591	638	685

OPTIONS

Glides	Rotating Tablet	Book Rack	Plastic	Fabric/Grade
X9 None - Standard W23 Clear Nylon Glides (4 Glides Per Set) \$15	X9 None - Standard TR4 Right Hand Seated \$120 TL4 Left Hand Seated \$120 NOTE: Available on armless chairs only and are non-stackable with tablet.	X9 None - Standard BR4 Chrome Book Rack \$65	BAT Battleship BLK Black BRD Bordeaux CHN Chestnut DPB Deep Blue SAG Sage SND Sand SLT Slate WHT White	Grade, Vendor, Pattern, Color NOTE: For multiple fabric applications see page 14 for information and pricing

HOW TO ORDER

SPECIFY: Glides | dolly | rotating tablet | book rack | plastic | textile pattern and color. See pages 5-14 for information and options on moisture barrier, CAL133, and upholstery applications.

MODEL NUMBER

412UB

Glides	Rotating Tablet	Book Rack	Plastic	Fabric/Grade
X9	X9	X9	BLK	Grade 3, Momentum, Hue, Smoke

GUEST/STACKING STANDARD FEATURES

- Chrome Wall Saver Frame
- Fixed Arm
- Stacks 14 High on the Floor (Plastic Seat)
- Stacks 7 High on the Floor (Upholstered Seat)

• All Styles Rated up to 300 lbs.
 SHIPPING NOTE: Chairs are packed four to a carton.
 Order quantities not divisible by four are subject to a carton breakage charge of \$30 list per order, per chair model upcharge.

NOTE: Weight based on four chairs. Optional Dolly and Ganging Device Available on Page 278.

PLASTIC BACK

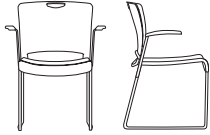

	w	outside d	h	sw	seat sd	sh	inside back	arm height	from floor	weight lbs.	cubic feet
plastic	19	22	32	17.75	18	17.5	16	7.75	25	75	15.25
uph.	24.25	22	32	17.75	18	18	16	7.75	25	75	15.25

- Nine plastic colors

model	yds com (54")	sq ft col	com 1	col 2	3	4	5	6	7	8	9	10	11	12	13	14	15	L1	L2	L3
Upholstered Seat with Plastic Back																				
409	1	17.5	312	328	347	371	404	451	498	545	592	639	686	733	780	827	874	535	582	629

list

Plastic Seat and Back

\$ 222

MESH BACK

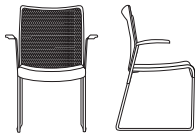

	w	outside d	h	sw	seat sd	sh	inside back	arm height	from floor	weight lbs.	cubic feet
plastic	19	22	31	17.75	18	17.5	15	7.75	25	75	15.25
uph.	24.25	22	31	17.75	18	18	15	7.75	25	75	15.25

- Three mesh back colors

model	yds com (54")	sq ft col	com 1	col 2	3	4	5	6	7	8	9	10	11	12	13	14	15	L1	L2	L3
Upholstered Seat with Mesh Back																				
409M	1	17.5	380	396	415	439	472	519	566	613	660	707	754	801	848	895	942	603	650	697

list

Plastic Seat

\$ 289

OPTIONS

Glides	Rotating Tablet	Book Rack	Plastic	Mesh Back (409M Only)	Seat Material	Fabric/Grade
X9 None - Standard W23 Clear Nylon Glides (4 Glides Per Set) \$15	X9 None - Standard TR4 Right Hand Seated \$120 TL4 Left Hand Seated \$120 NOTE: Available on armless chairs only and are non-stackable with tablet.	X9 None - Standard BR4 Chrome Book Rack \$65	BAT Battleship BLK Black BRD Bordeaux CHN Chestnut DPB Deep Blue SAG Sage SND Sand SLT Slate WHT White	MBK Black MDG Dark Gray MSL Silver	Plastic Upholstered	Grade, Vendor, Pattern, Color NOTE: For multiple fabric applications see page 14 for information and pricing

HOW TO ORDER

SPECIFY: Glides | rotating tablet | book rack | plastic | mesh back | textile pattern and color.
 See pages 5-14 for information and options on moisture barrier, CAL133 and upholstery applications.

MODEL NUMBER

C409

Glides	Rotating Tablet	Book Rack	Plastic	Mesh Back	Seat Material	Fabric/Grade
X9	X9	X9	BAT		Upholstered	Grade 3, Momentum, Hue, Smoke

GUEST/STACKING STANDARD FEATURES

- Chrome Wall Saver Frame
- Fixed Arm
- Nine Plastic Colors
- Stacks 7 High on the Floor

• All Styles Rated up to 300 lbs.
 SHIPPING NOTE: Chairs are packed four to a carton. Order quantities not divisible by four are subject to a carton breakage charge of \$30 list per order, per chair model upcharge.

NOTE: Weight based on four chairs. Optional Dolly and Ganging Device Available on Page 278

UPHOLSTERED BACK AND SEAT

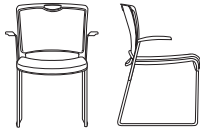

w	outside d	h	sw	seat sd	sh	inside back	arm height	from floor	weight lbs.	cubic feet
24.25	22	32	17.75	18	18	16	7.75	25	92	15.25

• Black plastic is standard on upholstered seats and backs unless otherwise specified.

model	yds com (54")	sq ft col	com 1	col 2	3	4	5	6	7	8	9	10	11	12	13	14	15	L1	L2	L3
409UB	1	29	417	433	452	476	509	556	603	650	697	744	791	838	885	932	979	640	687	734

OPTIONS

Glides	Rotating Tablet	Book Rack	Plastic	Fabric/Grade
X9 None - Standard W23 Clear Nylon Glides (4 Glides Per Set) \$15	X9 None - Standard TR4 Right Hand Seated \$120 TL4 Left Hand Seated \$120 NOTE: Available on armless chairs only and are non-stackable with tablet.	X9 None - Standard BR4 Chrome Book Rack \$65	BAT Battleship BLK Black BRD Bordeaux CHN Chestnut DPB Deep Blue SAG Sage SND Sand SLT Slate WHT White	Grade, Vendor, Pattern, Color NOTE: For multiple fabric applications see page 14 for information and pricing

HOW TO ORDER

SPECIFY: Glides | rotating tablet | book rack | plastic | textile pattern and color. See pages 5-14 for information and options on moisture barrier, CAL133 and upholstery applications.

MODEL NUMBER

C409UB

Glides	Rotating Tablet	Book Rack	Plastic	Fabric/Grade
X9	X9	X9	BAT	Grade 3, Momentum, Hue, Smoke

REIN+ GUEST STANDARD FEATURES

- Rated to 500 lbs.
- European Beech Hardwood Frame
- Mortise-and-Tenon Construction
- Clean-Thru Design
- Field Replaceable Components
- Wall-Saver Design
- Non-Marring Adjustable Glides
- Can be Ganged to other Rein+ Units using 1810-G or 1810-TG

GUEST CHAIR



w	outside d	h	sw	seat sd	sh	seat to top of back	arm height	weight lbs.	cubic feet
22.75	25.25	32.5	20.25	20	17.5	15	25.5	23	12

model	yds com (54")	sq ft col	com 1	col 2	3	4	5	6	7	8	9	10	11	12	13	14	15	L1	L2	L3
1810	1.25	n/a	720	741	764	793	835	893	952	1,011	1,070	1,129	1,187	1,246	1,305	1,364	1,422	992	1,051	1,109

OPTIONS

Arm Caps	Finish	Removable Covers	Fabric 1
Standard X9 No Arm Cap	Selection Required	Standard X9 No Selection of Option	Selection Required
Resin \$101 pair DIN Black DIM Taupe DIP Grey Solid Surface \$185 pair CWS Cameo White MWS Modern White CSS Concrete DMS Deep Mink	See page 9 for full list of finish options	B1L Removable Seat Cover only \$98	Fabric: Grade, Vendor, Pattern, Color NOTE: For multiple fabric applications see page 14 for information and pricing

HOW TO ORDER

SPECIFY: Arm caps | wood finish | removable covers | textile pattern and color. See pages 5-14 for information and options on moisture barrier, CAL133, upholstery applications, a complete offering of finishes and ordering details.

MODEL NUMBER

1810

Arm Caps	Finish	Removable Covers	Fabric 1
DIN	MLC	B1L	Grade 5, Momentum, Row, Breeze

RULE OF THREE GUEST CHAIR STANDARD FEATURES

- 3/4" Tubular Bent Luster Grey Powder Coated Metal Frame
- Black Resin Arm Cap is Standard
- European Beech Wood Arm Cap is Optional
- Upholstered Seat and Back
- Spring Seat Construction
- Clean-Thru Design
- Wall-Saver Design
- Tight Cushion
- White Plastic Glide fitted into the Bottom of Tubular Leg
- Field Replaceable Components

GUEST CHAIR



w	outside d	h	sw	seat sd	sh	seat to top of back	arm height	weight lbs.	cubic feet
23.5	25	31.75	21.25	18.5	18.5	13.5	25.5	35	19

model	yds com (54")	sq ft col	com 1	col 2	3	4	5	6	7	8	9	10	11	12	13	14	15	L1	L2	L3
1392	1.5	n/a	817	842	870	905	955	1,025	1,096	1,166	1,237	1,307	1,378	1,448	1,519	1,589	1,660	1,137	1,209	1,278

OPTIONS

Arm Caps	Powder Coat	Removable Covers	Fabric 1
Standard DIN Black Resin	Standard MSL Luster Grey	Standard X9 No Selection of Option	Selection Required
A3 Wood (specify finish) \$76 pair	BWT Bone White BUFF Buff CHLK Chalk SGLD Gold GRPH Graphite MSL Luster Grey HIP Oiled Bronze BKO Onyx POLR Polar SBRZ Soft Bronze HIF Warm Grey	H7 Removable Seat and Back Covers \$202 B1L Removable Seat Cover only \$101 B1M Removable Back Cover only \$101	Fabric: Grade, Vendor, Pattern, Color NOTE: For multiple fabric applications see page 14 for information and pricing

HOW TO ORDER

SPECIFY: Arm caps | arm cap finish (if applicable) | powder coat | removable covers | textile pattern and color. See pages 5-14 for information and options on moisture barrier, CAL133, upholstery applications, a complete offering of finishes and ordering details.

MODEL NUMBER

1392

Arm Caps	Powder Coat	Removable Covers	Fabric 1
A3 - MNW	MSL	H7	Grade 5, Momentum, Row, Breeze

SERONY GUEST STANDARD FEATURES

- Upholstered Seat and Back
- Wall-Saver Design
- Clean-Thru Design
- Tight Cushion
- Luster Grey Powder Coat on all Exposed Metal
- Black Poly Arm Caps
- Non-Marring Adjustable Glides

GUEST CHAIR

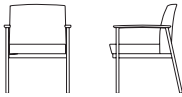

w	outside d	h	sw	seat sd	sh	seat to top of back	arm height	weight lbs.	cubic feet
25	26	33	21.5	20	18	15.25	25	45	19

model	yds com (54")	sq ft col	com 1	col 2	3	4	5	6	7	8	9	10	11	12	13	14	15	L1	L2	L3
1472	1.5	n/a	896	921	949	984	1,034	1,104	1,175	1,245	1,316	1,386	1,457	1,527	1,598	1,688	1,739	1,216	1,288	1,357

OPTIONS

Frame Finish	Arm Cap Finish	Fabric 1
Standard MSL Luster Grey	Standard DIN Black Poly	Selection Required
BWT Bone White BUFF Buff CHLK Chalk SGLD Gold GRPH Graphite MSL Luster Grey HIP Oiled Bronze BKO Onyx POLR Polar SBRZ Soft Bronze HIF Warm Grey	D1M Taupe Poly D1P Grey Poly A3 Wood (specify finish) Solid Surface \$220 pair CWS Cameo White MWS Modern White CSS Concrete DMS Deep Mink	Fabric : Grade, Vendor, Pattern, Color NOTE: For multiple fabric applications see page 14 for information and pricing

HOW TO ORDER

SPECIFY: Finish | arm cap finish (if applicable) | powder coat | textile pattern and color. See pages 5-14 for information and options on moisture barrier, CAL133, upholstery applications, a complete offering of finishes and ordering details.

MODEL NUMBER

1472

Frame Finish	Arm Cap Finish	Fabric 1
MSL	D1N	Grade 5, Momentum, Row, Breeze

SILVR ION METAL GUEST STANDARD FEATURES

- 360° Clean-Thru Design
- Rated to 400 lbs.
- Upholstered Seat and Back
- Field Replaceable Components
- European Beech Arm Caps
- Warm Grey (with Silver Ion Antimicrobial) Powder Coat on all Exposed Metal is Standard
- Wall-Saver Design
- Non-Marring Adjustable Glides

GUEST CHAIR



outside			seat			seat to top of back	arm height	weight lbs.	cubic feet
w	d	h	sw	sd	sh				
25	26	33	21	18.5	19	14.25	25	60	21

model	yds com (54")	sq ft col	com 1	col 2	3	4	5	6	7	8	9	10	11	12	13	14	15	L1	L2	L3
1471	1.5	n/a	1,086	1,111	1,139	1,174	1,224	1,294	1,365	1,435	1,506	1,576	1,647	1,717	1,788	1,858	1,929	1,406	1,478	1,547

OPTIONS

Arm Caps	Finish	Powder Coat	Removable Covers	Fabric 1
Standard A3 Wood	Standard X9 No Selection of Option	Standard H1F Warm Grey (with Silver Ion Antimicrobial)	Standard X9 No Selection of Option	Selection Required
D1N Poly (black) D1M Poly (taupe) D1N Poly (grey)	See page 9 for full list of finish options	See page 9 for full list of powder coat options NOTE: Any other powder coat specified will not have Silver Ion antimicrobial technology	H7 Removable Seat and Back Covers \$196 B1L Removable Seat Cover only \$98 B1M Removable Back Cover only \$98	NOTE: For multiple fabric applications see page 14 for information and pricing

HOW TO ORDER

SPECIFY: Arm caps | finish (if applicable) | powder coat | removable covers | textile pattern and color. See pages 5-14 for information and options on moisture barrier, CAL133, upholstery applications, a complete offering of finishes and ordering details.

MODEL NUMBER

1441

Arm Caps	Finish	Powder Coat	Removable Covers	Fabric 1
D1N	MLC	H1F	H7	Grade 5, Momentum, Row, Breeze

SILVR ION WOOD GUEST STANDARD FEATURES

- 360° Clean-Thru Design
- Rated to 400 lbs.
- Upholstered Seat and Back
- Field Replaceable Components
- European Beech Arm Caps and Overlay on Legs (1441 only)
- European Beech Arm Caps (1471 only)
- Warm Grey (with Silver Ion Antimicrobial) Powder Coat on all Exposed Metal is Standard
- Wall-Saver Design
- Non-Marring Adjustable Glides

GUEST CHAIR

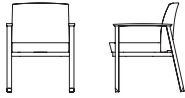

w	outside d	h	sw	seat sd	sh	seat to top of back	arm height	weight lbs.	cubic feet
25	26	33	21	18.5	19	14.25	25	60	20

model	yds com (54")	sq ft col	com 1	col 2	3	4	5	6	7	8	9	10	11	12	13	14	15	L1	L2	L3
1441	1.5	n/a	1,463	1,488	1,516	1,551	1,601	1,671	1,742	1,812	1,883	1,953	2,024	2,094	2,165	2,235	2,306	1,783	1,855	1,924

OPTIONS

Arm Caps	Finish	Powder Coat	Removable Covers	Arm Panels	Fabric 1
Standard A3 Wood	Standard X9 No Selection of Option	Standard H1F Warm Grey (with Silver Ion Antimicrobial)	Standard X9 No Selection of Option	Standard X9 No Selection of Option	Selection Required
D1N Poly (black) D1M Poly (taupe) D1N Poly (grey)	See page 9 for full list of finish options NOTE: Select finish when 1441 model or A3 wood arm cap option is specified	See page 9 for full list of powder coat options NOTE: Any other powder coat specified will not have Silver Ion antimicrobial technology	H7 Removable Seat and Back Covers \$196 B1L Removable Seat Cover only \$98 B1M Removable Back Cover only \$98	WAP Pair of Wood (specify finish) \$418 UAP Pair of Upholstered (specify textile) (see pricing below) NOTE: Available on 1441 Silvr Ion Wood only	Fabric: Grade, Vendor, Pattern, Color NOTE: For multiple fabric applications see page 14 for information and pricing

Arm Panel Options

yds com (54")	sq ft col	com 1	col 2	3	4	5	6	7	8	9	10	11	12	13	14	15	L1	L2	L3
0.75	n/a	529	541	555	573	598	633	668	704	739	774	809	845	880	915	950	703	739	774

HOW TO ORDER

SPECIFY: Arm caps | finish (if applicable) | powder coat | removable covers | arm panels (if applicable) | textile pattern and color. See pages 5-14 for information and options on moisture barrier, CAL133, upholstery applications, a complete offering of finishes and ordering details.

MODEL NUMBER

1441

Arm Caps	Finish	Powder Coat	Removable Covers	Arm Panels	Fabric 1
D1N	MLC	H1F	H7	WAP - MLC	Grade 5, Momentum, Row, Breeze

GUEST/STACKING STANDARD FEATURES

- Armless
- Glides
- Stacks Four High on the Floor
- All Styles Rated up to 300 lbs.

SHIPPING NOTE: Chairs are packed three to a carton. Order quantities not divisible by three are subject to a carton breakage charge of \$30 list per order, per chair model upcharge.

NOTES: Weight based on three chairs. Stacking not recommended with casters. Optional Dolly and Ganging Device available on page 278.

PLASTIC BACK

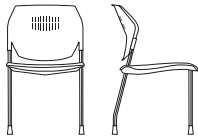

	w	outside		sw	seat		inside back	arm height	from floor	weight lbs.	cubic feet
		d	h		sd	sh					
plastic	20.5	22.75	33.5	15.5	19	18.5	15	n/a	n/a	67	15.17
fixed arms (A5)									8	27.25	
uph.	20.5	22.75	33.5	16	19	18.75	15	n/a	n/a	67	15.17
fixed arms (A5)									8	27.25	

- Six plastic colors

model	yds com (54")	sq ft col	com 1	col 2	3	4	5	6	7	8	9	10	11	12	13	14	15	L1	L2	L3
Upholstered Seat with Plastic Back																				
701	1	17.5	389	405	424	448	481	528	575	622	669	716	763	810	857	904	951	612	659	706

list

Plastic Seat and Back

\$ 312

MESH BACK

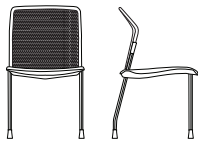

	w	outside		sw	seat		inside back	arm height	from floor	weight lbs.	cubic feet
		d	h		sd	sh					
	20.5	22.75	33.75	16	19	18.75	16	n/a	n/a	48	17.27
fixed arms (A5)									8	27.25	

- Three mesh back colors

model	yds com (54")	sq ft col	com 1	col 2	3	4	5	6	7	8	9	10	11	12	13	14	15	L1	L2	L3
701M	1	17.3	388	404	423	447	480	527	574	621	668	715	762	809	856	903	950	611	658	705

OPTIONS

Frame	Arms	Casters/Glides	Plastic	Mesh Back (701M Only)	Seat Material	Seat Foam	Fabric/Grade
BF Black SF Silver	X9 No Arms - Standard  A5 Fixed Arms \$50 NOTE: Available in black only.	W26 High Glides - Standard W15A Hard Wheel Casters with Safety Brake \$72 W16 Soft Wheel Casters with Safety Brake \$72 W48 Hard Wheel Casters \$42 W49 Soft Wheel Casters \$72	BAT Battleship BLK Black CHN Chestnut SAG Sage SLT Slate WHT White	MBK Black MDG Dark Gray MSL Silver	Plastic Upholstered	X9 None - Standard AF1 1/2" Additional Seat Foam \$35 NOTE: Add additional 10% for COM. Available on Upholstered Seat only.	X9 None Grade, Vendor, Pattern, Color NOTE: For multiple fabric applications see page 14 for information and pricing

HOW TO ORDER

SPECIFY: Frame | arms | casters/glides | plastic | mesh back | seat material | seat foam | textile pattern and color. See pages 5-14 for information and options on moisture barrier, CAL133, upholstery applications.

MODEL NUMBER

701

Frame	Arms	Casters/Glides	Plastic	Mesh Back (701M Only)	Seat Material	Seat Foam	Fabric/Grade
BF	X9	W26	BAT	MBK	Upholstered	X9	Grade 3, Momentum, Hue, Smoke

GUEST/STACKING STANDARD FEATURES

- Armless
- Fully Upholstered
- Stacks Four High on the Floor with Glides
- Glides

• All Styles Rated up to 300 lbs.
 SHIPPING NOTE: Chairs are packed three to a carton. Order quantities not divisible by three are subject to a carton breakage charge of \$30 list per order, per chair model upcharge.

NOTE: Weight based on three chairs. Stacking not recommended with casters. Optional Dolly and Ganging Device Available on Page 278.

UPHOLSTERED BACK AND SEAT

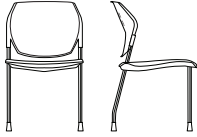

w	outside d	h	sw	seat sd	sh	inside back	arm height	from floor	weight lbs.	cubic feet
20.5	22.75	33.5	16	19	18.75	15	n/a	n/a	69	15.25
fixed arms (A5)							8	27.25	74	

- Six plastic colors
- Black plastic is standard on upholstered seats and backs unless otherwise specified.

model	yds com (54")	sq ft col	com 1	col 2	3	4	5	6	7	8	9	10	11	12	13	14	15	L1	L2	L3
701UB	1	29	490	506	525	549	582	629	676	723	770	817	864	911	958	1,005	1,052	713	760	807

OPTIONS

Frame	Arms	Casters/Glides	Seat Foam	Plastic	Fabric/Grade
BF Black SF Silver	X9 No Arms - Standard  A5 Fixed Arms \$50 NOTE: Arm available in black only.	W26 High Glides - Standard W15A Hard Wheel Casters with Safety Brake \$30 W16 Soft Wheel Casters with Safety Brake \$30 W48 Hard Wheel Casters \$30 W49 Soft Wheel Casters \$30	X9 None - Standard AF1 1/2" Additional Seat Foam \$35 NOTE: Add additional 10% for COM.	BAT Battleship BLK Black CHN Chestnut SAG Sage SLT Slate WHT White	Grade, Vendor, Pattern, Color NOTE: For multiple fabric applications see page 14 for information and pricing

HOW TO ORDER

SPECIFY: Arms | casters/glides | seat foam | plastic | textile pattern and color.
 See pages 5-14 for information and options on moisture barrier, CAL133, upholstery applications.

MODEL NUMBER

C701UB

Frame	Arms	Casters/Glides	Seat Foam	Plastic	Fabric/Grade
BF	X9	W26	X9	BAT	Grade 4, Momentum, Hue, Smoke

VOYAGE GUEST STANDARD FEATURES

- Clean-Thru Design
- Upholstered Seat and Back
- European Beech Exterior Frame
- European Beech Open Arm Frame
- European Beech Exterior Frame
- Wall-Saver Design
- Field Replaceable Components
- Non-Marring Adjustable Glides

GUEST CHAIR

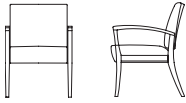

w	outside		sw	seat		seat to top of back	arm height	weight lbs.	cubic feet
	d	h		sd	sh				
24	26.5	34	21	19.5	17	17	25.5	40	19

model	yds com (54")	sq ft col	com 1	col 2	3	4	5	6	7	8	9	10	11	12	13	14	15	L1	L2	L3
1520	1.5	n/a	1,014	1,039	1,067	1,102	1,152	1,222	1,293	1,363	1,434	1,504	1,575	1,645	1,716	1,786	1,857	1,334	1,406	1,475

OPTIONS

Frame Finish	Arm Cap Finish	Removable Covers	Fabric 1
Selection Required	Standard X9 No Arm Cap	Standard X9 No Selection of Option	Selection Required
MBM EBY MMC PCO MLC BUW MHM QEC MVW MGO DST MRO OSL MNW MGW	A4 Poly (black) \$185 pair	H7 Removable Seat and Back Covers \$196 B1L Removable Seat Cover only \$98 B1M Removable Back Cover only \$98	Fabric: Grade, Vendor, Pattern, Color NOTE: For multiple fabric applications see page 14 for information and pricing

HOW TO ORDER

SPECIFY: Finish | arm cap finish | removable covers | textile pattern and color. See pages 5-14 for information and options on moisture barrier, CAL133, upholstery applications, a complete offering of finishes and ordering details.

MODEL NUMBER

1520

Frame Finish	Arm Cap Finish	Removable Covers	Fabric 1
MLC	A4	H7	Grade 5, Momentum, Row, Breeze

CONFIGURING AND ORDERING

The following information uses examples that apply to all of our multiple seating series. By following these **three easy steps**, your multiple seating order will be clearly indicated and correctly entered. Multiple seating units are shipped assembled up to four components per carton.

1-2-3 STEP-BY-STEP ORDERING

• **Step 1**

Choose the series that you wish to order.

• **Step 2**

Design a seating layout that meets the requirements of your specific space. Configure components from left to right (facing). Remember when middle or hang tables are positioned between two chairs, both of those chairs must be base chair units.

• **Step 3**

On your Purchase Order configure the components in order as they should be assembled. The following examples are for the Orchestra 1408 series, but works in the same fashion for all multiple seating series.

EXAMPLES

EXAMPLE A

Qty. 1 1408-2-A-A A4-MNW-X9 -5/Momentum, Row, Breeze
 Arm Caps: Poly Arm Cap (A4)
 Finish: Natural Walnut (MNW)
 Removable Covers: None (X9)
 Fabric: Grade 5, Momentum, Row, Breeze
 Qty. 1 Indicates the quantity ordered
1408» Indicates the series required
2-A-A» Indicates the assembly order

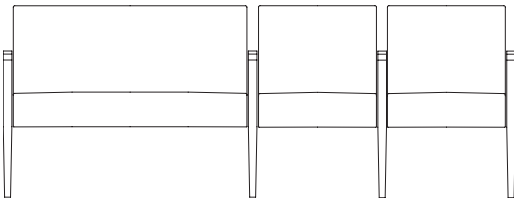

EXAMPLE B

Qty. 1 1408-C-E A4-MNW-X9 -5/Momentum, Row, Breeze
 Arm Caps: Poly Arm Cap (A4)
 Finish: Natural Walnut (MNW)
 Removable Covers: None (X9)
 Fabric: Grade 5, Momentum, Row, Breeze
 Qty. 1 Indicates the quantity ordered
1408» Indicates the series required
C-E» Indicates the assembly order

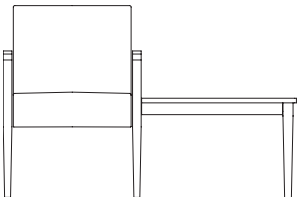

To ensure accuracy please provide Customer Service with a diagram of your specific configuration requirements at time of order.

INTERLUDE UPHOLSTERED BACK WITH UPHOLSTERED ARMS MULTIPLE STANDARD FEATURES

- Clean-Thru Design
- Upholstered Seat and Back
- Upholstered Arm Panel with European Beech Arm Cap
- Wallsaver Design
- Legs made of 1 x 2 16 Gauge Tubing (.06" Wall Thickness)
- Field Replaceable Components
- Non-Marring Adjustable Glides

UPHOLSTERED BACK W/ UPHOLSTERED ARM PANELS, BASE CHAIR



w	outside d	h	sw	seat sd	sh	seat to top of back	arm height	weight lbs.	cubic feet
25	24.5	36.75	20.5	18	19	17.75	25.5	35	27

model	yds com (54")	sq ft col	com 1	col 2	3	4	5	6	7	8	9	10	11	12	13	14	15	L1	L2	L3
1922-C	2.25	n/a	1,624	1,661	1,703	1,756	1,830	1,936	2,042	2,148	2,254	2,359	2,465	2,571	2,677	2,783	2,888	2,091	2,197	2,302

UPHOLSTERED BACK W/ UPHOLSTERED ARM PANELS, BASE LOVESEAT

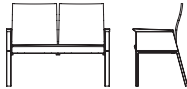

w	outside d	h	sw	seat sd	sh	seat to top of back	arm height	weight lbs.	cubic feet
46	24.5	36.75	41.5	18	19	17.75	25.5	63	40

model	yds com (54")	sq ft col	com 1	col 2	3	4	5	6	7	8	9	10	11	12	13	14	15	L1	L2	L3
1922-2	3.25	n/a	2,144	2,197	2,259	2,335	2,442	2,595	2,748	2,900	3,053	3,206	3,359	3,512	3,665	3,817	3,970	2,806	2,960	3,111

UPHOLSTERED BACK W/ UPHOLSTERED ARM PANELS, BASE BARIATRIC

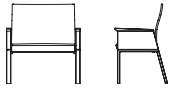

w	outside d	h	sw	seat sd	sh	seat to top of back	arm height	weight lbs.	cubic feet
34.5	24.5	36.75	30	18	19	17.75	25.5	47	27

• Rated for 500 lbs.

model	yds com (54")	sq ft col	com 1	col 2	3	4	5	6	7	8	9	10	11	12	13	14	15	L1	L2	L3
1922-OB	2.75	n/a	1,727	1,772	1,824	1,889	1,979	2,108	2,238	2,367	2,496	2,626	2,755	2,884	3,014	3,143	3,272	2,291	2,422	2,550

OPTIONS

Arm Caps	Powder Coat	Removable Covers	Fabric 1
Standard	Selection Required	Standard	Selection Required
A3 Wood (specify finish)		X9 No Selection of Option	
A4 Poly (black) \$231 pair	BWT Bone White BUFF Buff CHLK Chalk SGLD Gold GRPH Graphite MSL Luster Grey HIP Oiled Bronze BKO Onyx POLR Polar SBRZ Soft Bronze HIF Warm Grey	H7 Removable Seat and Back Covers \$197 BIL Removable Seat Cover only \$98 BIM Removable Back Cover only \$98	Fabric: Grade, Vendor, Pattern, Color NOTE: For multiple fabric applications see page 14 for information and pricing

HOW TO ORDER

SPECIFY: Arm caps | arm cap finish (if applicable) | powder coat | removable covers | textile pattern and color. See pages 5-14 for information and options on moisture barrier, CAL133, upholstery applications, a complete offering of finishes and ordering details.

MODEL NUMBER

1922-C

Arm Caps	Powder Coat	Removable Covers	Fabric 1
A4	BWT	H7	Grade 5, Momentum, Row, Breeze

INTERLUDE UPHOLSTERED BACK WITH UPHOLSTERED ARMS MULTIPLE STANDARD FEATURES

- Clean-Thru Design
- Upholstered Seat and Back
- Upholstered Arm Panel with European Beech Arm Cap
- Wallsaver Design
- Legs made of 1 x 2 16 Gauge Tubing (.06" Wall Thickness)
- Field Replaceable Components
- Non-Marring Adjustable Glides

UPHOLSTERED BACK W/ UPHOLSTERED ARM PANELS, ADD ON CHAIR



w	outside d	h	sw	seat sd	sh	seat to top of back	arm height	weight lbs.	cubic feet
23	24.5	36.75	20.5	18	19	17.75	25.5	35	27

model	yds com (54")	sq ft col	com 1	col 2	3	4	5	6	7	8	9	10	11	12	13	14	15	L1	L2	L3
1922-A	2	n/a	1,337	1,370	1,408	1,455	1,520	1,614	1,708	1,803	1,897	1,991	2,085	2,179	2,273	2,367	2,461	1,755	1,850	1,943

UPHOLSTERED BACK W/ UPHOLSTERED ARM PANELS, ADD ON LOVESEAT

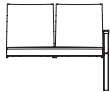

w	outside d	h	sw	seat sd	sh	seat to top of back	arm height	weight lbs.	cubic feet
44	24.5	36.75	41.5	18	19	17.75	25.5	58	40

model	yds com (54")	sq ft col	com 1	col 2	3	4	5	6	7	8	9	10	11	12	13	14	15	L1	L2	L3
1922-2A	2.75	n/a	1,825	1,870	1,922	1,987	2,077	2,206	2,336	2,465	2,594	2,724	2,853	2,982	3,112	3,241	3,370	2,389	2,520	2,648

UPHOLSTERED BACK W/ UPHOLSTERED ARM PANELS, ADD ON BARIATRIC



w	outside d	h	sw	seat sd	sh	seat to top of back	arm height	weight lbs.	cubic feet
32.5	24.5	36.75	30	18	19	17.75	25.5	47	27

• Rated for 500 lbs.

model	yds com (54")	sq ft col	com 1	col 2	3	4	5	6	7	8	9	10	11	12	13	14	15	L1	L2	L3
1922-OBA	2.75	n/a	1,457	1,502	1,554	1,619	1,709	1,838	1,968	2,097	2,226	2,356	2,485	2,614	2,744	2,873	3,002	2,021	2,152	2,280

OPTIONS

Arm Caps	Powder Coat	Removable Covers	Fabric 1
Standard	Selection Required	Standard	Selection Required
A3 Wood (specify finish)		X9 No Selection of Option	
A4 Poly (black) \$115 per arm cap	BWT Bone White BUFF Buff CHLK Chalk SGLD Gold GRPH Graphite MSL Luster Grey HIP Oiled Bronze BKO Onyx POLR Polar SBRZ Soft Bronze HIF Warm Grey	H7 Removable Seat and Back Covers \$196 BIL Removable Seat Cover only \$98 BIM Removable Back Cover only \$98	Fabric: Grade, Vendor, Pattern, Color NOTE: For multiple fabric applications see page 14 for information and pricing

HOW TO ORDER

SPECIFY: Arm caps | arm cap finish (if applicable) | powder coat | removable covers | textile pattern and color. See pages 5-14 for information and options on moisture barrier, CAL133, upholstery applications, a complete offering of finishes and ordering details.

MODEL NUMBER

1922-A

Arm Caps	Powder Coat	Removable Covers	Fabric 1
A4	BWT	H7	Grade 5, Momentum, Row, Breeze

INTERLUDE UPHOLSTERED BACK WITH OPEN ARMS MULTIPLE STANDARD FEATURES

- Clean-Thru Design
- Upholstered Seat and Back
- European Beech Open Arm Frame with Arm Cap
- Wallsaver Design
- Legs made of 1 x 2 16 Gauge Tubing (.06" Wall Thickness)
- Field Replaceable Components
- Non-Marring Adjustable Glides

UPHOLSTERED BACK W/ OPEN ARMS BASE CHAIR



w	outside			sw	seat			seat to top of back	arm height	weight lbs.	cubic feet
	d	h			sd	sh					
25	24.5	36.75		20.5	18	19		17.75	25.5	35	27

model	yds com (54")	sq ft col	com 1	col 2	3	4	5	6	7	8	9	10	11	12	13	14	15	L1	L2	L3
1922OA-C	1.5	n/a	1,649	1,674	1,702	1,737	1,787	1,857	1,928	1,998	2,069	2,139	2,210	2,280	2,351	2,421	2,492	1,969	2,041	2,110

UPHOLSTERED BACK W/ OPEN ARMS BASE LOVESEAT

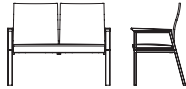

w	outside			sw	seat			seat to top of back	arm height	weight lbs.	cubic feet
	d	h			sd	sh					
46	24.5	36.75		41.5	18	19		17.75	25.5	63	40

model	yds com (54")	sq ft col	com 1	col 2	3	4	5	6	7	8	9	10	11	12	13	14	15	L1	L2	L3
1922OA-2	2.75	n/a	2,211	2,256	2,308	2,373	2,463	2,592	2,722	2,851	2,980	3,110	3,239	3,368	3,498	3,627	3,756	2,775	2,906	3,034

UPHOLSTERED BACK W/ OPEN ARMS BASE BARIATRIC

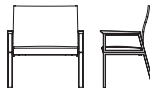

w	outside			sw	seat			seat to top of back	arm height	weight lbs.	cubic feet
	d	h			sd	sh					
34.5	24.5	36.75		30	18	19		17.75	25.5	47	27

• Rated for 500 lbs.

model	yds com (54")	sq ft col	com 1	col 2	3	4	5	6	7	8	9	10	11	12	13	14	15	L1	L2	L3
1922OA-OB	2	n/a	1,747	1,780	1,818	1,865	1,930	2,024	2,118	2,213	2,307	2,401	2,495	2,589	2,683	2,777	2,871	2,165	2,260	2,353

OPTIONS

Arm Caps	Finish	Powder Coat	Removable Covers	Fabric 1
Standard	Selection Required	Selection Required	Standard	Selection Required
A3 Wood (specify finish)			X9 No Selection of Option	
A4 Poly (black) \$231 pair	See page 9 for full list of finish options	BWT Bone White BUFF Buff CHLK Chalk SGLD Gold GRPH Graphite MSL Luster Grey H1P Oiled Bronze BKO Onyx POLR Polar SBRZ Soft Bronze HIF Warm Grey	H7 Removable Seat and Back Covers \$196 B1L Removable Seat Cover only \$98 B1M Removable Back Cover only \$98	Fabric: Grade, Vendor, Pattern, Color NOTE: For multiple fabric applications see page 14 for information and pricing

HOW TO ORDER

SPECIFY: Arm caps | wood finish | powder coat | removable covers | textile pattern and color. See pages 5-14 for information and options on moisture barrier, CAL133, upholstery applications, a complete offering of finishes and ordering details.

MODEL NUMBER

1922OA-C

Arm Caps	Finish	Powder Coat	Removable Covers	Fabric 1
A4	MLC	BWT	H7	Grade 5, Momentum, Row, Breeze

INTERLUDE UPHOLSTERED BACK WITH OPEN ARMS MULTIPLE STANDARD FEATURES

- Clean-Thru Design
- Upholstered Seat and Back
- European Beech Open Arm Frame with Arm Cap
- Wallsaver Design
- Legs made of 1 x 2 16 Gauge Tubing (.06" Wall Thickness)
- Field Replaceable Components
- Non-Marring Adjustable Glides

UPHOLSTERED BACK W/ OPEN ARMS ADD ON CHAIR



w	outside			sw	seat			seat to top of back	arm height	weight lbs.	cubic feet
	d	h			sd	sh					
23	24.5	36.75		20.5	18	19	17.75	25.5	35	27	

model	yds com (54")	sq ft col	com 1	col 2	3	4	5	6	7	8	9	10	11	12	13	14	15	L1	L2	L3
1922OA-A	1.5	n/a	1,327	1,352	1,380	1,415	1,465	1,535	1,606	1,676	1,747	1,817	1,888	1,958	2,029	2,099	2,170	1,647	1,719	1,788

UPHOLSTERED BACK W/ OPEN ARMS ADD ON LOVESEAT

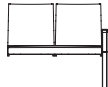

w	outside			sw	seat			seat to top of back	arm height	weight lbs.	cubic feet
	d	h			sd	sh					
44	24.5	36.75		41.5	18	19	17.75	25.5	58	40	

model	yds com (54")	sq ft col	com 1	col 2	3	4	5	6	7	8	9	10	11	12	13	14	15	L1	L2	L3
1922OA-2A	2.75	n/a	1,915	1,960	2,012	2,077	2,167	2,296	2,426	2,555	2,684	2,814	2,943	3,072	3,202	3,331	3,460	2,479	2,610	2,738

UPHOLSTERED BACK W/ OPEN ARMS ADD ON BARIATRIC



w	outside			sw	seat			seat to top of back	arm height	weight lbs.	cubic feet
	d	h			sd	sh					
32.5	24.5	36.75		30	18	19	17.75	25.5	42	27	

• Rated for 500 lbs.

model	yds com (54")	sq ft col	com 1	col 2	3	4	5	6	7	8	9	10	11	12	13	14	15	L1	L2	L3
1922OA-OBA	2	n/a	1,446	1,479	1,517	1,564	1,629	1,723	1,817	1,912	2,006	2,100	2,194	2,288	2,382	2,476	2,570	1,864	1,959	2,052

OPTIONS

Arm Caps	Finish	Powder Coat	Removable Covers	Fabric 1
Standard A3 Wood (specify finish)	Selection Required	Selection Required	Standard X9 No Selection of Option	Selection Required
A4 Poly (black) \$115 per arm cap	See page 9 for full list of finish options	BWT Bone White BUFF Buff CHLK Chalk SGLD Gold GRPH Graphite MSL Luster Grey H1P Oiled Bronze BKO Onyx POLR Polar SBRZ Soft Bronze H1F Warm Grey	H7 Removable Seat and Back Covers \$196 B1L Removable Seat Cover only \$98 B1M Removable Back Cover only \$98	Fabric: Grade, Vendor, Pattern, Color NOTE: For multiple fabric applications see page 14 for information and pricing

HOW TO ORDER

SPECIFY: Arm caps | wood finish | powder coat | removable covers | textile pattern and color. See pages 5-14 for information and options on moisture barrier, CAL133, upholstery applications, a complete offering of finishes and ordering details.

MODEL NUMBER

1922OA-A

Arm Caps	Finish	Powder Coat	Removable Covers	Fabric 1
A4	MLC	BWT	H7	Grade 5, Momentum, Row, Breeze

INTERLUDE GANGING TABLE STANDARD FEATURES

- Top Options - European Beech Veneer, HPL or TFL with Stain Matched MDF Filled Edge or Solid Surface
- Visible Powder Coated Support Bar under Table Surface
- Legs made of 1 x 2 16 Gauge Tubing (.06" Wall Thickness) on 1921-E
- Wallsaver Design on 1921-E
- Non-Marring Adjustable Glides on 1921-E

MIDDLE TABLE



model		w	d	h	wt	cu ft	list
1921-M	VENEER/LAMINATE	21	21	17	30	15	\$ 583
	SOLID SURFACE						\$ 1,791

END TABLE

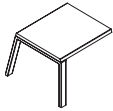

model		w	d	h	wt	cu ft	list
1921-E	VENEER/LAMINATE	21	21	17	50	15	\$ 639
	SOLID SURFACE						\$ 1,848

CORNER 45° HANG TABLE



model		w	d	h	wt	cu ft	list
1921-45	VENEER/LAMINATE	21.75	21.75	17	50	15	\$ 710
	SOLID SURFACE						\$ 1,813

CORNER 90° HANG TABLE



model		w	d	h	wt	cu ft	list
1921-90	VENEER/LAMINATE	28.75	28.75	17	50	15	\$ 1,105
	SOLID SURFACE						\$ 3,468

OPTIONS

Powder Coat	Top
Selection Required	Selection Required
BWT Bone White BUFF Buff CHLK Chalk SGLD Gold GRPH Graphite MSL Luster Grey HIP Oiled Bronze BKO Onyx POLR Polar SBRZ Soft Bronze HIF Warm Grey	Veneer (Lumberband Edge) HPL (Stain Matched MDF Filled Edge) TFL (Stain Matched MDF Filled Edge) Solid Surface See pages 9-10 for full list of finish, HPL, TFL and Solid Surface options

HOW TO ORDER

SPECIFY: Base - Powder coat | Top - Veneer finish, HPL, TFL or solid surface. See pages 5-14 for a complete offering of finishes and ordering details.

MODEL NUMBER

1921-M

Powder Coat	Top
BWT	NWP

MODERN AMENITY OPEN ARM MULTIPLE SEATING STANDARD FEATURES

- Upholstered Seat and Back
- Spring Seat Construction
- Clean-Thru Design
- Wallsaver Design
- Must specify European Beech or American Ash Frame
- Wood Arm Cap
- Non-Marring Adjustable Glides
- Field Replaceable Components
- NOTE: Because of the unique Color of Ash Hardwoods, Stains are a slightly different Color than they appear on the Standard European Beech Hardwoods. If pairing with a Product using Species other than Ash the Stains will appear different. For additional information please contact your Customer Service Representative.
- NOTE: Tandem Units can only be ganged and added on to by using the Ganging Tables. You can not add on a Chair directly to a Tandem Unit.

BASE CHAIR, OPEN ARM

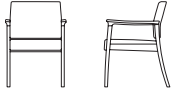

w	outside			sw	seat			seat to top of back	arm height	weight lbs.	cubic feet
	d	h			sd	sh					
24	26	34.5		20.75	22.25	19	15	26.75	38	19	

model	yds com (54")	sq ft col	com 1	col 2	3	4	5	6	7	8	9	10	11	12	13	14	15	L1	L2	L3
1600-C	1.5	n/a	1,209	1,234	1,262	1,297	1,347	1,417	1,488	1,558	1,629	1,699	1,770	1,840	1,911	1,981	2,052	1,529	1,601	1,670

LOVESEAT, OPEN ARM

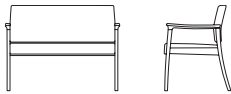

w	outside			sw	seat			seat to top of back	arm height	weight lbs.	cubic feet
	d	h			sd	sh					
45.5	26	34.5		41	22.25	19	15	26.75	68	33	

model	yds com (54")	sq ft col	com 1	col 2	3	4	5	6	7	8	9	10	11	12	13	14	15	L1	L2	L3
1600-2	2.5	n/a	1,722	1,763	1,810	1,869	1,951	2,069	2,186	2,304	2,421	2,539	2,657	2,774	2,892	3,009	3,127	2,237	2,356	2,472

BARIATRIC BASE CHAIR, OPEN ARM



w	outside			sw	seat			seat to top of back	arm height	weight lbs.	cubic feet
	d	h			sd	sh					
33	26	34.5		29.75	22.25	19	15	26.75	55	26	

model	yds com (54")	sq ft col	com 1	col 2	3	4	5	6	7	8	9	10	11	12	13	14	15	L1	L2	L3
1600-OB	2	n/a	1,512	1,545	1,583	1,630	1,695	1,789	1,883	1,978	2,072	2,166	2,260	2,354	2,448	2,542	2,636	1,930	2,025	2,118

OPTIONS

Wood Species	Arm Caps	Finish	Removable Covers	Fabric 1
Selection Required	Standard A3 Wood Arm Cap	Selection Required	Standard X9 No Selection of Option	Selection Required
A8S European Beech A8T American Ash	Poly \$109 pair D1N Black D1M Taupe D1P Grey Solid Surface \$624 pair CWS Cameo White MWS Modern White CSS Concrete DMS Deep Mink	See page 9 for full list of finish options	H7 Removable Seat and Back Covers \$196 B1L Removable Seat Cover only \$98 B1M Removable Back Cover only \$98	Fabric: Grade, Vendor, Pattern, Color NOTE: For multiple fabric applications see page 14 for information and pricing

HOW TO ORDER

SPECIFY: Wood species | arm caps | wood finish | removable covers | textile pattern and color. See pages 5-14 for information and options on moisture barrier, CAL133, upholstery applications, a complete offering of finishes and ordering details.

MODEL NUMBER

1600-C

Wood Species	Arm Caps	Finish	Removable Covers	Fabric 1
A8S	A3	MLC	H7	Grade 5, Momentum, Row, Breeze

MODERN AMENITY OPEN ARM MULTIPLE SEATING STANDARD FEATURES

- Upholstered Seat and Back
- Spring Seat Construction
- Clean-Thru Design
- Wallsaver Design
- Must specify European Beech or American Ash Frame
- Wood Arm Cap
- Non-Marring Adjustable Glides
- Field Replaceable Components
- NOTE: Because of the unique Color of Ash Hardwoods, Stains are a slightly different Color than they appear on the Standard European Beech Hardwoods. If pairing with a Product using Species other than Ash the Stains will appear different. For additional information please contact your Customer Service Representative.
- NOTE: Tandem Units can only be ganged and added on to by using the Ganging Tables. You can not add on a Chair directly to a Tandem Unit.

ADD ON CHAIR, OPEN ARM



w	outside			sw	seat			seat to top of back	arm height	weight lbs.	cubic feet
	d	h	sd		sh						
22.25	26	34.5	20.75	22.25	19	15	26.75	34	19		

model	yds com (54")	sq ft col	com 1	col 2	3	4	5	6	7	8	9	10	11	12	13	14	15	L1	L2	L3
1600-A	1.5	n/a	1,082	1,107	1,135	1,170	1,220	1,290	1,361	1,431	1,502	1,572	1,643	1,713	1,784	1,854	1,925	1,402	1,474	1,543

LOVESEAT ADD ON, OPEN ARM

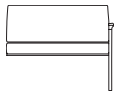

w	outside			sw	seat			seat to top of back	arm height	weight lbs.	cubic feet
	d	h	sd		sh						
43.75	26	34.5	41	22.25	19	15	26.75	64	33		

model	yds com (54")	sq ft col	com 1	col 2	3	4	5	6	7	8	9	10	11	12	13	14	15	L1	L2	L3
1600-2A	2.5	n/a	1,603	1,644	1,691	1,750	1,832	1,950	2,067	2,185	2,302	2,420	2,538	2,655	2,773	2,890	3,008	2,118	2,237	2,353

ADD ON BARIATRIC CHAIR, OPEN ARM



w	outside			sw	seat			seat to top of back	arm height	weight lbs.	cubic feet
	d	h	sd		sh						
31.25	26	34.5	29.75	22.25	19	15	26.75	51	26		

model	yds com (54")	sq ft col	com 1	col 2	3	4	5	6	7	8	9	10	11	12	13	14	15	L1	L2	L3
1600-OBA	2	n/a	1,372	1,405	1,443	1,490	1,555	1,649	1,743	1,838	1,932	2,026	2,120	2,214	2,308	2,402	2,496	1,790	1,885	1,978

OPTIONS

Wood Species	Arm Caps	Finish	Removable Covers	Fabric 1
Selection Required	Standard A3 Wood Arm Cap	Selection Required	Standard X9 No Selection of Option	Selection Required
A8S European Beech A8T American Ash	Poly \$55 per arm cap D1N Black D1M Taupe D1P Grey Solid Surface \$312 per arm cap CWS Cameo White MWS Modern White CSS Concrete DMS Deep Mink	See page 9 for full list of finish options	H7 Removable Seat and Back Covers \$196 B1L Removable Seat Cover only \$98 B1M Removable Back Cover only \$98	Fabric: Grade, Vendor, Pattern, Color NOTE: For multiple fabric applications see page 14 for information and pricing

HOW TO ORDER

SPECIFY: Wood species | arm caps | wood finish | removable covers | textile pattern and color. See pages 5-14 for information and options on moisture barrier, CAL133, upholstery applications, a complete offering of finishes and ordering details.

MODEL NUMBER

1600-A

Wood Species	Arm Caps	Finish	Removable Covers	Fabric 1
A8S	A3	MLC	H7	Grade 5, Momentum, Row, Breeze

MODERN AMENITY OPEN ARM TANDEM SEATING STANDARD FEATURES

- Upholstered Seat and Back
- Spring Seat Construction
- Clean-Thru Design
- Wallsaver Design
- Must specify European Beech or American Ash Frame
- Wood Arm Cap
- Non-Marring Adjustable Glides
- Field Replaceable Components
- NOTE: Because of the unique Color of Ash Hardwoods, Stains are a slightly different Color than they appear on the Standard European Beech Hardwoods. If pairing with a Product using Species other than Ash the Stains will appear different. For additional information please contact your Customer Service Representative.
- NOTE: Tandem Units can only be ganged and added on to by using the Ganging Tables. You can not add on a Chair directly to a Tandem Unit.

TANDEM CHAIR/CHAIR, OPEN ARM

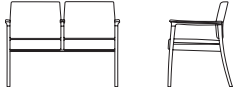

w	outside			sw	seat			seat to top of back							arm height	weight lbs.	cubic feet
	d	h		sd	sh												
45.5	26	34.5		42.25	22.25	19	15							26.75	71	33	

model	yds com (54")	sq ft col	com 1	col 2	3	4	5	6	7	8	9	10	11	12	13	14	15	L1	L2	L3
1600T-CC	3	n/a	2,351	2,400	2,457	2,527	2,626	2,767	2,908	3,049	3,190	3,331	3,473	3,614	3,755	3,896	4,037	2,964	3,106	3,246

TANDEM CHAIR/CHAIR/CHAIR, OPEN ARM

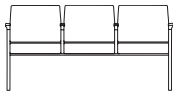

w	outside			sw	seat			seat to top of back							arm height	weight lbs.	cubic feet
	d	h		sd	sh												
67	26	34.5		63.75	22.25	19	15							26.75	94	48	

model	yds com (54")	sq ft col	com 1	col 2	3	4	5	6	7	8	9	10	11	12	13	14	15	L1	L2	L3
1600T-CCC	4.5	n/a	3,410	3,484	3,569	3,675	3,823	4,034	4,246	4,457	4,669	4,881	5,092	5,304	5,515	5,727	5,939	4,315	4,529	4,738

TANDEM LOVESEAT/CHAIR, OPEN ARM

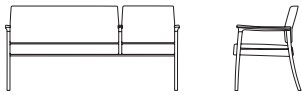

w	outside			sw	seat			seat to top of back							arm height	weight lbs.	cubic feet
	d	h		sd	sh												
67	26	34.5		63.75	22.25	19	15							26.75	94	48	

model	yds com (54")	sq ft col	com 1	col 2	3	4	5	6	7	8	9	10	11	12	13	14	15	L1	L2	L3
1600T-LC	4.5	n/a	3,481	3,555	3,640	3,746	3,894	4,105	4,317	4,528	4,740	4,952	5,163	5,375	5,586	5,798	6,010	4,386	4,600	4,809

TANDEM CHAIR/LOVESEAT, OPEN ARM

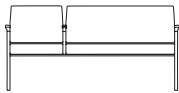

w	outside			sw	seat			seat to top of back							arm height	weight lbs.	cubic feet
	d	h		sd	sh												
67	26	34.5		63.75	22.25	19	15							26.75	94	48	

model	yds com (54")	sq ft col	com 1	col 2	3	4	5	6	7	8	9	10	11	12	13	14	15	L1	L2	L3
1600T-CL	4.5	n/a	3,481	3,555	3,640	3,746	3,894	4,105	4,317	4,528	4,740	4,952	5,163	5,375	5,586	5,798	6,010	4,386	4,600	4,809

OPTIONS

Wood Species	Arm Caps	Finish	Removable Covers	Fabric 1
Selection Required	Standard A3 Wood Arm Cap	Selection Required	Standard X9 No Selection of Option	Selection Required
A8S European Beech A8T American Ash	Poly \$55 per arm cap D1N Black D1M Taupe D1P Grey Solid Surface \$312 per arm cap CWS Cameo White MWS Modern White CSS Concrete DMS Deep Mink	See page 9 for full list of finish options	H7 Removable Seat and Back Covers \$196 B1L Removable Seat Cover only \$98 B1M Removable Back Cover only \$98	NOTE: For multiple fabric applications see page 14 for information and pricing

HOW TO ORDER

SPECIFY: Wood species | arm caps | wood finish | removable covers | textile pattern and color. See pages 5-14 for information and options on moisture barrier, CAL133, upholstery applications, a complete offering of finishes and ordering details.

MODEL NUMBER

1600T-CC

Wood Species	Arm Caps	Finish	Removable Covers	Fabric 1
A8S	A3	MLC	H7	Grade 5, Momentum, Row, Breeze

MODERN AMENITY OPEN ARM CHAIR/TABLE/CHAIR TANDEM SEATING STANDARD FEATURES

- Upholstered Seat and Back
- Spring Seat Construction
- Clean-Thru Design
- Wallsaver Design
- Must specify European Beech or American Ash Frame
- Wood Arm Cap
- Must specify Table Top Material, Color and Options
- Non-Marring Adjustable Glides
- Field Replaceable Components
- NOTE: Because of the unique Color of Ash Hardwoods, Stains are a slightly different Color than they appear on the Standard European Beech Hardwoods. If pairing with a Product using Species other than Ash the Stains will appear different. For additional information please contact your Customer Service Representative.
- NOTE: Tandem Units can only be ganged and added on to by using the Ganging Tables. You can not add on a Chair directly to a Tandem Unit.

TANDEM CHAIR/TABLE/CHAIR, OPEN ARM

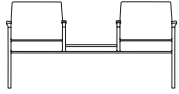

outside			seat			seat to top of back	arm height	weight lbs.	cubic feet
w	d	h	sw	sd	sh				
67	26	34.5	63.75	22.25	19	14.25	26.75	82	48

List Price with Veneer Middle Table

model	yds com (54")	sq ft col	com 1	col 2	3	4	5	6	7	8	9	10	11	12	13	14	15	L1	L2	L3
1600T-CMC	3	n/a	2,988	3,037	3,094	3,164	3,263	3,404	3,545	3,686	3,827	3,968	4,110	4,251	4,392	4,533	4,674	3,601	3,743	3,883

List Price with Laminate Middle Table

model	yds com (54")	sq ft col	com 1	col 2	3	4	5	6	7	8	9	10	11	12	13	14	15	L1	L2	L3
1600T-CMC	3	n/a	3,100	3,149	3,206	3,276	3,375	3,516	3,657	3,798	3,939	4,080	4,222	4,363	4,504	4,645	4,786	3,713	3,855	3,995

List Price with Solid Surface Middle Table

model	yds com (54")	sq ft col	com 1	col 2	3	4	5	6	7	8	9	10	11	12	13	14	15	L1	L2	L3
1600T-CMC	3	n/a	3,323	3,372	3,429	3,499	3,598	3,739	3,880	4,021	4,162	4,303	4,445	4,586	4,727	4,868	5,009	3,936	4,078	4,218

List Price with 3DL Middle Table

model	yds com (54")	sq ft col	com 1	col 2	3	4	5	6	7	8	9	10	11	12	13	14	15	L1	L2	L3
1600T-CMC	3	n/a	3,164	3,213	3,270	3,340	3,439	3,580	3,721	3,862	4,003	4,144	4,286	4,427	4,568	4,709	4,850	3,777	3,919	4,059

OPTIONS

Wood Species	Arm Caps	Finish	Removable Covers	Top	Spill Groove	Fabric 1
Selection Required	Standard A3 Wood (specify finish)	Selection Required	Standard X9 No Selection of Option	Standard X9 Veneer Match to Exposed Wood Finish	Selection Required Available only on 3DL and Solid Surface	Selection Required
A8S European Beech A8T American Ash See page 9 for complete offering of finishes	Poly \$55 per arm cap D1N Black D1M Taupe D1P Grey Solid Surface \$312 per arm cap CWS Cameo White MWS Modern White CSS Concrete DMS Deep Mink	See page 9 for full list of finish options	H7 Removable Seat and Back Covers \$196 B1L Removable Seat Cover only \$98 B1M Removable Back Cover only \$98	HPL (Veneer Edge) TFL (Veneer Edge) 3DL Solid Surface See pages 9-10 for full list of HPL, TFL, 3DL and Solid Surface options	X9 None C6H Spill Groove	Fabric: Grade, Vendor, Pattern, Color NOTE: For multiple fabric applications see page 14 for information and pricing

HOW TO ORDER

SPECIFY: Wood species | arm caps | wood finish | removable covers | Top - Veneer finish, HPL, TFL, 3DL or solid surface | spill groove | textile pattern and color. See pages 5-14 for information and options on moisture barrier, CAL133, upholstery applications, a complete offering of finishes and ordering details.

MODEL NUMBER

1600T-CMC

Wood Species	Arm Caps	Finish	Removable Covers	Top	Spill Groove	Fabric 1
A8S	BSQ	MLC	H7	BSQ	C6H	Grade 5, Momentum, Row, Breeze

MODERN AMENITY GANGING TABLES STANDARD FEATURES

- Top Options - Veneer, HPL or TFL with Veneer Edge, 3DL or Solid Surface
- Exposed Wood Apron on 1600-M and Exposed Wood Leg on 1600-E. Wood Species and Finish must be specified for Both.
- Non-Marring Adjustable Glides on 1600-E
- Field Replaceable Components
- NOTE: Because of the unique Color of Ash Hardwoods, Stains are a slightly different Color than they appear on the Standard European Beech Hardwoods. If pairing with a Product using Species other than Ash the Stains will appear different. For additional information please contact your Customer Service Representative.

MIDDLE TABLE

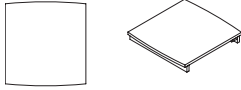

model		w	d	h	wt	cu ft	list
1600-M	VENEER	20.25	21	2.5	12	15	\$ 409
	LAMINATE						\$ 512
	SOLID SURFACE						\$ 727
	3DL						\$ 572

90 DEGREE TABLE

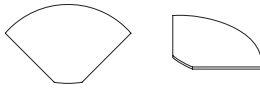

model		w	d	h	wt	cu ft	list
1600-90	VENEER	35.75	22.5	0.75	18	15	\$ 495
	LAMINATE						\$ 655
	SOLID SURFACE						\$ 1,059
	3DL						\$ 642

END TABLE

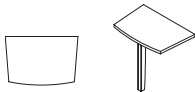

model		w	d	h	wt	cu ft	list
1600-E	VENEER	12	18	16.5	15	10	\$ 350
	LAMINATE						\$ 435
	SOLID SURFACE						\$ 549
	3DL						\$ 458

OPTIONS

Wood Species	Exposed Wood Finish	Top	Spill Groove
Selection Required	Selection Required	Standard X9 Veneer Match to Exposed Wood Finish	Selection Required Available only on 3DL and Solid Surface
A8S European Beech A8T American Ash	See page 9 for full list of finish options	HPL (Veneer Edge) TFL (Veneer Edge) 3DL Solid Surface See pages 9-10 for full list of HPL, TFL, 3DL and Solid Surface options	X9 None C6H Spill Groove

HOW TO ORDER

SPECIFY: Base - Wood species | wood finish | Top - Veneer finish, HPL, TFL, 3DL or solid surface | spill groove. See pages 5-14 for a complete offering of finishes and ordering details.

MODEL NUMBER

1600-M

Wood Species	Exposed Wood Finish	Top	Spill Groove
A8S	MLC	BSQ	X9

MODERN AMENITY PANEL ARM MULTIPLE SEATING STANDARD FEATURES

- Upholstered Arm Panels, Seat and Back
- Spring Seat Construction
- Clean-Thru Design
- Wallsaver Design
- Must specify European Beech or American Ash Frame
- Wood Arm Cap
- Non-Marring Adjustable Glides
- Field Replaceable Components
- NOTE: Because of the unique Color of Ash Hardwoods, Stains are a slightly different Color than they appear on the Standard European Beech Hardwoods. If pairing with a Product using Species other than Ash the Stains will appear different. For additional information please contact your Customer Service Representative.
- NOTE: Tandem Units can only be ganged and added on to by using the Ganging Tables. You can not add on a Chair directly to a Tandem Unit.

BASE CHAIR, PANEL ARM



w	outside			sw	seat			seat to top of back	arm height	weight lbs.	cubic feet
	d	h			sd	sh					
24	26	34.5		20.75	22.25	19		15	26.75	42	19

model	yds com (54")	sq ft col	com 1	col 2	3	4	5	6	7	8	9	10	11	12	13	14	15	L1	L2	L3
1610-C	2.25	n/a	1,308	1,345	1,387	1,440	1,514	1,620	1,726	1,832	1,938	2,043	2,149	2,255	2,361	2,467	2,572	1,775	1,881	1,986

LOVESEAT, PANEL ARM

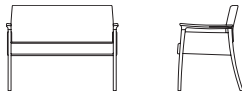

w	outside			sw	seat			seat to top of back	arm height	weight lbs.	cubic feet
	d	h			sd	sh					
45.5	26	34.5		41	22.25	19		15	26.75	72	33

model	yds com (54")	sq ft col	com 1	col 2	3	4	5	6	7	8	9	10	11	12	13	14	15	L1	L2	L3
1610-2	3.25	n/a	1,763	1,816	1,878	1,954	2,061	2,214	2,367	2,519	2,672	2,825	2,978	3,131	3,284	3,436	3,589	2,425	2,579	2,730

BARIATRIC BASE CHAIR, PANEL ARM



w	outside			sw	seat			seat to top of back	arm height	weight lbs.	cubic feet
	d	h			sd	sh					
33	26	34.5		29.75	22.25	19		15	26.75	59	26

model	yds com (54")	sq ft col	com 1	col 2	3	4	5	6	7	8	9	10	11	12	13	14	15	L1	L2	L3
1610-OB	2.75	n/a	1,605	1,650	1,702	1,767	1,857	1,986	2,116	2,245	2,374	2,504	2,633	2,762	2,892	3,021	3,150	2,169	2,300	2,428

OPTIONS

Wood Species	Arm Caps	Finish	Removable Covers	Fabric 1
Selection Required	Standard A3 Wood Arm Cap	Selection Required	Standard X9 No Selection of Option	Selection Required
A8S European Beech A8T American Ash	Poly \$110 pair D1N Black D1M Taupe D1P Grey Solid Surface \$624 pair CWS Cameo White MWS Modern White CSS Concrete DMS Deep Mink	See page 9 for full list of finish options	H7 Removable Seat and Back Covers \$196 B1L Removable Seat Cover only \$98 B1M Removable Back Cover only \$98	Fabric: Grade, Vendor, Pattern, Color NOTE: For multiple fabric applications see page 14 for information and pricing

HOW TO ORDER

SPECIFY: Wood species | arm caps | wood finish | removable covers | textile pattern and color. See pages 5-14 for information and options on moisture barrier, CAL133, upholstery applications, a complete offering of finishes and ordering details.

MODEL NUMBER

1610-C

Wood Species	Arm Caps	Finish	Removable Covers	Fabric 1
A8S	A3	MLC	H7	Grade 5, Momentum, Row, Breeze

MODERN AMENITY PANEL ARM MULTIPLE SEATING STANDARD FEATURES

- Upholstered Arm Panels, Seat and Back
- Spring Seat Construction
- Clean-Thru Design
- Wallsaver Design
- Must specify European Beech or American Ash Frame
- Wood Arm Cap
- Non-Marring Adjustable Glides
- Field Replaceable Components
- NOTE: Because of the unique Color of Ash Hardwoods, Stains are a slightly different Color than they appear on the Standard European Beech Hardwoods. If pairing with a Product using Species other than Ash the Stains will appear different. For additional information please contact your Customer Service Representative.
- NOTE: Tandem Units can only be ganged and added on to by using the Ganging Tables. You can not add on a Chair directly to a Tandem Unit.

ADD ON CHAIR, PANEL ARM



w	outside			sw	seat			seat to top of back	arm height	weight lbs.	cubic feet
	d	h	sd		sh						
22.25	26	34.5	20.75	22.25	19	15	26.75	38	19		

model	yds com (54")	sq ft col	com 1	col 2	3	4	5	6	7	8	9	10	11	12	13	14	15	L1	L2	L3
1610-A	2.25	n/a	1,147	1,184	1,226	1,279	1,353	1,459	1,565	1,671	1,777	1,882	1,988	2,094	2,200	2,306	2,411	1,614	1,720	1,825

LOVESEAT ADD ON, PANEL ARM

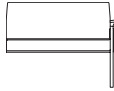

w	outside			sw	seat			seat to top of back	arm height	weight lbs.	cubic feet
	d	h	sd		sh						
43.75	26	34.5	41	22.25	19	15	26.75	68	33		

model	yds com (54")	sq ft col	com 1	col 2	3	4	5	6	7	8	9	10	11	12	13	14	15	L1	L2	L3
1610-2A	3.25	n/a	1,659	1,712	1,774	1,850	1,957	2,110	2,263	2,415	2,568	2,721	2,874	3,027	3,180	3,332	3,485	2,321	2,475	2,626

ADD ON BARIATRIC CHAIR, PANEL ARM



w	outside			sw	seat			seat to top of back	arm height	weight lbs.	cubic feet
	d	h	sd		sh						
31.25	26	34.5	29.75	22.25	19	15	26.75	55	26		

model	yds com (54")	sq ft col	com 1	col 2	3	4	5	6	7	8	9	10	11	12	13	14	15	L1	L2	L3
1610-OBA	2.75	n/a	1,428	1,473	1,525	1,590	1,680	1,809	1,939	2,068	2,197	2,327	2,456	2,585	2,715	2,844	2,973	1,992	2,123	2,251

OPTIONS

Wood Species	Arm Caps	Finish	Removable Covers	Fabric 1
Selection Required	Standard A3 Wood Arm Cap	Selection Required	Standard X9 No Selection of Option	Selection Required
A8S European Beech A8T American Ash	Poly \$55 per arm cap D1N Black D1M Taupe D1P Grey Solid Surface \$312 per arm cap CWS Cameo White MWS Modern White CSS Concrete DMS Deep Mink	See page 9 for full list of finish options	H7 Removable Seat and Back Covers \$198 B1L Removable Seat Cover only \$98 B1M Removable Back Cover only \$98	Fabric: Grade, Vendor, Pattern, Color NOTE: For multiple fabric applications see page 14 for information and pricing

HOW TO ORDER

SPECIFY: Wood species | arm caps | wood finish | removable covers | textile pattern and color. See pages 5-14 for information and options on moisture barrier, CAL133, upholstery applications, a complete offering of finishes and ordering details.

MODEL NUMBER

1610-A

Wood Species	Arm Caps	Finish	Removable Covers	Fabric 1
A8S	A3	MLC	H7	Grade 5, Momentum, Row, Breeze

MODERN AMENITY PANEL ARM TANDEM SEATING STANDARD FEATURES

- Upholstered Arm Panels, Seat and Back
- Spring Seat Construction
- Clean-Thru Design
- Wallsaver Design
- Must specify European Beech or American Ash Frame
- Wood Arm Cap
- Non-Marring Adjustable Glides
- Field Replaceable Components
- NOTE: Because of the unique Color of Ash Hardwoods, Stains are a slightly different Color than they appear on the Standard European Beech Hardwoods. If pairing with a Product using Species other than Ash the Stains will appear different. For additional information please contact your Customer Service Representative.
- NOTE: Tandem Units can only be ganged and added on to by using the Ganging Tables. You can not add on a Chair directly to a Tandem Unit.

TANDEM CHAIR/CHAIR, PANEL ARM

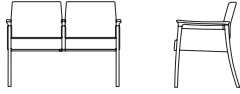

w	outside			sw	seat			seat to top of back	arm height	weight lbs.	cubic feet
	d	h	sd		sh						
45.5	26	34.5	42.25	22.25	19	15	26.75	75	33		

model	yds com (54")	sq ft col	com 1	col 2	3	4	5	6	7	8	9	10	11	12	13	14	15	L1	L2	L3
1610T-CC	5.25	n/a	2,515	2,601	2,700	2,824	2,996	3,243	3,490	3,737	3,984	4,231	4,478	4,725	4,971	5,218	5,465	3,567	3,815	4,060

TANDEM CHAIR/CHAIR/CHAIR, PANEL ARM

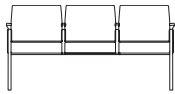

w	outside			sw	seat			seat to top of back	arm height	weight lbs.	cubic feet
	d	h	sd		sh						
67	26	34.5	63.75	22.25	19	15	26.75	98	48		

model	yds com (54")	sq ft col	com 1	col 2	3	4	5	6	7	8	9	10	11	12	13	14	15	L1	L2	L3
1610T-CCC	7.5	n/a	3,628	3,751	3,893	4,069	4,316	4,668	5,021	5,374	5,726	6,079	6,432	6,784	7,137	7,490	7,842	5,118	5,474	5,823

TANDEM LOVESEAT/CHAIR, PANEL ARM

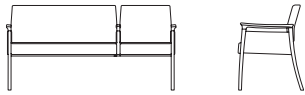

w	outside			sw	seat			seat to top of back	arm height	weight lbs.	cubic feet
	d	h	sd		sh						
67	26	34.5	63.75	22.25	19	15	26.75	98	48		

model	yds com (54")	sq ft col	com 1	col 2	3	4	5	6	7	8	9	10	11	12	13	14	15	L1	L2	L3
1610T-LC	7.5	n/a	3,660	3,783	3,925	4,101	4,348	4,700	5,053	5,406	5,758	6,111	6,464	6,816	7,169	7,522	7,874	5,150	5,506	5,855

TANDEM CHAIR/LOVESEAT, PANEL ARM

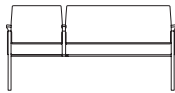

w	outside			sw	seat			seat to top of back	arm height	weight lbs.	cubic feet
	d	h	sd		sh						
67	26	34.5	63.75	22.25	19	15	26.75	98	48		

model	yds com (54")	sq ft col	com 1	col 2	3	4	5	6	7	8	9	10	11	12	13	14	15	L1	L2	L3
1610T-CL	7.5	n/a	3,660	3,783	3,925	4,101	4,348	4,700	5,053	5,406	5,758	6,111	6,464	6,816	7,169	7,522	7,874	5,150	5,506	5,855

OPTIONS

Wood Species	Arm Caps	Finish	Removable Covers	Fabric 1
Selection Required	Standard A3 Wood Arm Cap	Selection Required	Standard X9 No Selection of Option	Selection Required
A8S European Beech A8T American Ash	Poly \$55 per arm cap D1N Black D1M Taupe D1P Grey Solid Surface \$312 per arm cap CWS Cameo White MWS Modern White CSS Concrete DMS Deep Mink	See page 9 for full list of finish options	H7 Removable Seat and Back Covers \$198 B1L Removable Seat Cover only \$98 B1M Removable Back Cover only \$98	NOTE: For multiple fabric applications see page 14 for information and pricing

HOW TO ORDER

SPECIFY: Wood species | arm caps | wood finish | removable covers | textile pattern and color. See pages 5-14 for information and options on moisture barrier, CAL133, upholstery applications, a complete offering of finishes and ordering details.

MODEL NUMBER

1610T-CC

Wood Species	Arm Caps	Finish	Removable Covers	Fabric 1
A8S	A3	MLC	H7	Grade 5, Momentum, Row, Breeze

MODERN AMENITY PANEL ARM CHAIR/TABLE/CHAIR TANDEM SEATING STANDARD FEATURES

- Upholstered Arm Panels, Seat and Back
- Spring Seat Construction
- Clean-Thru Design
- Wallsaver Design
- Must specify European Beech or American Ash Frame
- Wood Arm Cap
- Must specify Table Top Material, Color and Options
- Non-Marring Adjustable Glides
- Field Replaceable Components
- NOTE: Because of the unique Color of Ash Hardwoods, Stains are a slightly different Color than they appear on the Standard European Beech Hardwoods. If pairing with a Product using Species other than Ash the Stains will appear different. For additional information please contact your Customer Service Representative.
- NOTE: Tandem Units can only be ganged and added on to by using the Ganging Tables. You can not add on a Chair directly to a Tandem Unit.

TANDEM CHAIR/TABLE/CHAIR, PANEL ARM

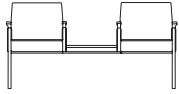

outside			seat			seat to top of back	arm height	weight lbs.	cubic feet
w	d	h	sw	sd	sh				
67	26	34.5	63.75	22.25	19	15	26.75	86	48

List Price with Veneer Middle Table

model	yds com (54")	sq ft col	com 1	col 2	3	4	5	6	7	8	9	10	11	12	13	14	15	L1	L2	L3
1610T-CMC	5.25	n/a	2,988	3,074	3,173	3,297	3,469	3,716	3,963	4,210	4,457	4,704	4,951	5,198	5,444	5,691	5,938	4,040	4,288	4,533

List Price with Laminate Middle Table

model	yds com (54")	sq ft col	com 1	col 2	3	4	5	6	7	8	9	10	11	12	13	14	15	L1	L2	L3
1610T-CMC	5.25	n/a	3,100	3,186	3,285	3,409	3,581	3,828	4,075	4,322	4,569	4,816	5,063	5,310	5,556	5,803	6,050	4,152	4,400	4,645

List Price with Solid Surface Middle Table

model	yds com (54")	sq ft col	com 1	col 2	3	4	5	6	7	8	9	10	11	12	13	14	15	L1	L2	L3
1610T-CMC	5.25	n/a	3,323	3,409	3,508	3,632	3,804	4,051	4,298	4,545	4,792	5,039	5,286	5,533	5,779	6,026	6,273	4,375	4,623	4,868

List Price with 3DL Middle Table

model	yds com (54")	sq ft col	com 1	col 2	3	4	5	6	7	8	9	10	11	12	13	14	15	L1	L2	L3
1610T-CMC	5.25	n/a	3,164	3,250	3,349	3,473	3,645	3,892	4,139	4,386	4,633	4,880	5,127	5,374	5,620	5,867	6,114	4,216	4,464	4,709

OPTIONS

Wood Species	Arm Caps	Finish	Removable Covers	Top	Spill Groove	Fabric 1
Selection Required	Standard A3 Wood (specify finish)	Selection Required	Standard X9 No Selection of Option	Standard X9 Veneer Match to Exposed Wood Finish	Selection Required Available only on 3DL and Solid Surface	Selection Required
A8S European Beech A8T American Ash See page 9 for complete offering of finishes	Poly \$55 per arm cap D1N Black D1M Taupe D1P Grey Solid Surface \$312 per arm cap CWS Cameo White MWS Modern White CSS Concrete DMS Deep Mink	See page 9 for full list of finish options	H7 Removable Seat and Back Covers \$198 B1L Removable Seat Cover only \$98 B1M Removable Back Cover only \$98	HPL (Veneer Edge) TFL (Veneer Edge) 3DL Solid Surface See pages 9-10 for full list of HPL, TFL, 3DL and Solid Surface options	X9 None C6H Spill Groove	Fabric: Grade, Vendor, Pattern, Color NOTE: For multiple fabric applications see page 14 for information and pricing

HOW TO ORDER

SPECIFY: Wood species | arm caps | wood finish | removable covers | Top - Veneer finish, HPL, TFL, 3DL or solid surface | spill groove | textile pattern and color. See pages 5-14 for information and options on moisture barrier, CAL133, upholstery applications, a complete offering of finishes and ordering details.

MODEL NUMBER

1610T-CMC

Wood Species	Arm Caps	Finish	Removable Covers	Top	Spill Groove	Fabric 1
A8S	BSQ	MLC	H7	BSQ	C6H	Grade 5, Momentum, Row, Breeze

MODERN AMENITY GANGING TABLES STANDARD FEATURES

- Top Options - Veneer, HPL or TFL with Veneer Edge, 3DL or Solid Surface
- Exposed Wood Apron on 1610-M and Exposed Wood Leg on 1610-E. Wood Species and Finish must be specified for Both.
- Non-Marring Adjustable Glides on 1610-E
- Field Replaceable Components
- NOTE: Because of the unique Color of Ash Hardwoods, Stains are a slightly different Color than they appear on the Standard European Beech Hardwoods. If pairing with a Product using Species other than Ash the Stains will appear different. For additional information please contact your Customer Service Representative.

MIDDLE TABLE

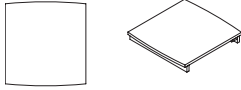

model		w	d	h	wt	cu ft	list
1610-M	VENEER	20.25	21	2.5	12	15	\$ 409
	LAMINATE						\$ 512
	SOLID SURFACE						\$ 727
	3DL						\$ 572

90 DEGREE TABLE

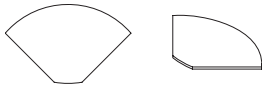

model		w	d	h	wt	cu ft	list
1610-90	VENEER	35.75	22.5	0.75	18	15	\$ 495
	LAMINATE						\$ 655
	SOLID SURFACE						\$ 1,059
	3DL						\$ 642

END TABLE

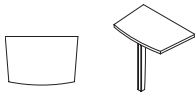

model		w	d	h	wt	cu ft	list
1610-E	VENEER	12	18	16.5	15	10	\$ 350
	LAMINATE						\$ 435
	SOLID SURFACE						\$ 549
	3DL						\$ 458

OPTIONS

Wood Species	Exposed Wood Finish	Top	Spill Groove
Selection Required	Selection Required	Standard X9 Veneer Match to Exposed Wood Finish	Selection Required Available only on 3DL and Solid Surface
A8S European Beech A8T American Ash	See page 9 for full list of finish options	HPL (Veneer Edge) TFL (Veneer Edge) 3DL Solid Surface See pages 9-10 for full list of HPL, TFL, 3DL and Solid Surface options	X9 None C6H Spill Groove

HOW TO ORDER

SPECIFY: Base - Wood species | wood finish | Top - Veneer finish, HPL, TFL, 3DL or solid surface | spill groove. See pages 5-14 for a complete offering of finishes and ordering details.

MODEL NUMBER

1610-M

Wood Species	Exposed Wood Finish	Top	Spill Groove
A8S	MLC	BSQ	X9

ORCHESTRA MULTIPLE STANDARD FEATURES

- 1408-OB rated for 500 lbs.
- Clean-Thru Design
- Upholstered Seat and Back
- European Beech Open Wood Arm Frame with Wood Arm Cap
- European Beech Exterior Frame
- Wall-Saver Design
- Non-Marring Adjustable Glides
- Field Replaceable Components

BASE CHAIR



w	outside			sw	seat			seat to top of back	arm height	weight lbs.	cubic feet
	d	h			sd	sh					
25	27.5	34		21	19	18	16.5	25.5	40	19	

model	yds com (54")	sq ft col	com 1	col 2	3	4	5	6	7	8	9	10	11	12	13	14	15	L1	L2	L3
1408-C	1.5	n/a	1,240	1,265	1,293	1,328	1,378	1,448	1,519	1,589	1,660	1,730	1,801	1,871	1,942	2,012	2,083	1,560	1,632	1,701

BASE LOVESEAT

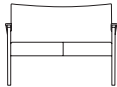

w	outside			sw	seat			seat to top of back	arm height	weight lbs.	cubic feet
	d	h			sd	sh					
49	27.5	34		41.25	19	18	16.5	25.5	70	33	

model	yds com (54")	sq ft col	com 1	col 2	3	4	5	6	7	8	9	10	11	12	13	14	15	L1	L2	L3
1408-2	2.75	n/a	1,621	1,666	1,718	1,783	1,873	2,002	2,132	2,261	2,390	2,520	2,649	2,778	2,908	3,037	3,166	2,185	2,316	2,444

BASE BARIATRIC



w	outside			sw	seat			seat to top of back	arm height	weight lbs.	cubic feet
	d	h			sd	sh					
34	27.5	34		30	19	18	16.5	25.5	50	26	

model	yds com (54")	sq ft col	com 1	col 2	3	4	5	6	7	8	9	10	11	12	13	14	15	L1	L2	L3
1408-OB	2	n/a	1,478	1,511	1,549	1,596	1,661	1,755	1,849	1,944	2,038	2,132	2,226	2,320	2,414	2,508	2,602	1,896	1,991	2,084

OPTIONS

Arm Caps	Finish	Removable Covers	Fabric 1
Standard A3 Wood	Selection Required	Standard X9 No Selection of Option	Selection Required
A4 Poly (black) \$185 pair	See page 9 for full list of finish options	H7 Removable Seat and Back Covers \$196 B1L Removable Seat Cover only \$98 B1M Removable Back Cover only \$98	Fabric: Grade, Vendor, Pattern, Color NOTE: For multiple fabric applications see page 14 for information and pricing

HOW TO ORDER

SPECIFY: Arm caps | wood finish | removable covers | textile pattern and color. See pages 5-14 for information and options on moisture barrier, CAL133, upholstery applications, a complete offering of finishes and ordering details.

MODEL NUMBER

1408-C

Arm Caps	Finish	Removable Covers	Fabric 1
A4	MNW	H7	Grade 5, Momentum, Row, Breeze

ORCHESTRA MULTIPLE STANDARD FEATURES

- 1408-OBA rated for 500 lbs.
- Clean-Thru Design
- Upholstered Seat and Back
- European Beech Open Wood Arm Frame with Wood Arm Cap
- European Beech Exterior Frame
- Wall-Saver Design
- Non-Marring Adjustable Glides

ADD ON CHAIR



w	outside			sw	seat			seat to top of back	arm height	weight lbs.	cubic feet
	d	h			sd	sh					
23	27.5	34		21	19	18	16.5	25.5	40	19	

model	yds com (54")	sq ft col	com 1	col 2	3	4	5	6	7	8	9	10	11	12	13	14	15	L1	L2	L3
1408-A	1.5	n/a	1,131	1,156	1,184	1,219	1,269	1,339	1,410	1,480	1,551	1,621	1,692	1,762	1,833	1,903	1,974	1,451	1,523	1,592

ADD ON LOVESEAT

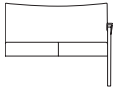

w	outside			sw	seat			seat to top of back	arm height	weight lbs.	cubic feet
	d	h			sd	sh					
47	27.5	34		41.25	19	18	16.5	25.5	70	33	

model	yds com (54")	sq ft col	com 1	col 2	3	4	5	6	7	8	9	10	11	12	13	14	15	L1	L2	L3
1408-2A	2.75	n/a	1,483	1,528	1,580	1,645	1,735	1,864	1,994	2,123	2,252	2,382	2,511	2,640	2,770	2,899	3,028	2,047	2,178	2,306

ADD ON BARIATRIC



w	outside			sw	seat			seat to top of back	arm height	weight lbs.	cubic feet
	d	h			sd	sh					
32	27.5	34		30	19	18	16.5	25.5	50	26	

model	yds com (54")	sq ft col	com 1	col 2	3	4	5	6	7	8	9	10	11	12	13	14	15	L1	L2	L3
1408-OBA	2	n/a	1,336	1,369	1,407	1,454	1,519	1,613	1,707	1,802	1,896	1,990	2,084	2,178	2,272	2,366	2,460	1,754	1,849	1,942

OPTIONS

Arm Caps	Finish	Removable Covers	Fabric 1
Standard A3 Wood	Selection Required	Standard X9 No Selection of Option	Selection Required
A4 Poly (black) \$93 per arm cap	See page 9 for full list of finish options	H7 Removable Seat and Back Covers \$196 B1L Removable Seat Cover only \$98 B1M Removable Back Cover only \$98	Fabric: Grade, Vendor, Pattern, Color NOTE: For multiple fabric applications see page 14 for information and pricing

HOW TO ORDER

SPECIFY: Arm caps | wood finish | removable covers | textile pattern and color. See **pages 5-14** for information and options on moisture barrier, CAL133, upholstery applications, a complete offering of finishes and ordering details.

MODEL NUMBER

1408-A

Arm Caps	Finish	Removable Covers	Fabric 1
A4	MNW	H7	Grade 5, Momentum, Row, Breeze

ORCHESTRA GANGING TABLE STANDARD FEATURES

- European Beech Exposed Wood
- Top Options - Veneer or HPL with Lumberband Edge
- Non-Marring Adjustable Glides on 1408-E

MIDDLE TABLE



model	w	d	h	wt	cu ft	list
1408-M	25	27.5	15.5	20	15	\$ 570

END TABLE



model	w	d	h	wt	cu ft	list
1408-E	21	24	15.5	20	15	\$ 720

OPTIONS

Exposed Wood Finish	Top
Selection Required	Standard X9 Veneer Match to Exposed Wood Finish
See page 9 for full list of finish options	HPL (Lumberband Edge Matched to Exposed Wood Finish) See page 10 for full list of HPL options

HOW TO ORDER

SPECIFY: Base - Wood finish | Top - Veneer finish or HPL. See pages 5-14 for a complete offering of finishes and ordering details.

MODEL NUMBER

1408-M

Exposed Wood Finish	Top
MNW	NWP

REIN+ GUEST STANDARD FEATURES

- Rated for 500 lbs.
- European Beech Hardwood Frame
- Mortise-and-Tenon Construction
- Clean-Thru Design
- Field Replaceable Components
- Wall-Saver Design
- Non-Marring Adjustable Glides
- Upholstered Seat and Back
- Can be Ganged to other Rein+ Units using 1810-G or 1810-TG

GUEST CHAIR

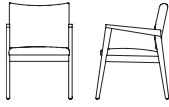

w	outside d	h	sw	seat sd	sh	seat to top of back	arm height	weight lbs.	cubic feet
22.75	25.25	32.5	20.25	20	17.5	15	25.5	23	12

model	yds com (54")	sq ft col	com 1	col 2	3	4	5	6	7	8	9	10	11	12	13	14	15	L1	L2	L3
1810	1.25	n/a	720	741	764	793	835	893	952	1,011	1,070	1,129	1,187	1,246	1,305	1,364	1,422	992	1,051	1,109

BARIATRIC CHAIR

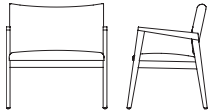

w	outside d	h	sw	seat sd	sh	seat to top of back	arm height	weight lbs.	cubic feet
31.75	25.25	32.5	29.25	20	17.5	15	25.5	35	23

model	yds com (54")	sq ft col	com 1	col 2	3	4	5	6	7	8	9	10	11	12	13	14	15	L1	L2	L3
1810-OB	2	n/a	947	980	1,018	1,065	1,130	1,224	1,318	1,413	1,507	1,601	1,695	1,789	1,883	1,977	2,071	1,365	1,460	1,553

OPTIONS

Arm Caps	Finish	Removable Covers	Fabric 1
Standard X9 No Arm Cap	Selection Required	Standard X9 No Selection of Option	Selection Required
Resin \$101 pair D1N Black D1M Taupe D1P Grey Solid Surface \$185 pair CWS Cameo White MWS Modern White CSS Concrete DMS Deep Mink	See page 9 for full list of finish options	B1L Removable Seat Cover only \$98	Fabric: Grade, Vendor, Pattern, Color NOTE: For multiple fabric applications see page 14 for information and pricing

HOW TO ORDER

SPECIFY: Arm caps | wood finish | removable covers | textile pattern and color. See pages 5-14 for information and options on moisture barrier, CAL133, upholstery applications, a complete offering of finishes and ordering details.

MODEL NUMBER

1810

Arm Caps	Finish	Removable Covers	Fabric 1
D1N	MLC	B1L	Grade 5, Momentum, Row, Breeze

REIN+ MULTIPLE STANDARD FEATURES

- Rated for 500 lbs. per Seat
- European Beech Hardwood Frame
- Mortise-and-Tenon Construction
- Clean-Thru Design
- Field Replaceable Components
- Wall-Saver Design
- Non-Marring Adjustable Glides
- Upholstered Seat and Back
- Can be Ganged to other Rein+ Units using 1810-G or 1810-TG

CHAIR/CHAIR TANDEM

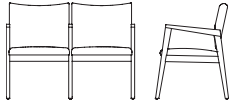

w	outside d	h	sw	seat sd	sh	seat to top of back	arm height	weight lbs.	cubic feet
44	25.25	32.5	20.25	20	17.5	15	25.5	46	23

model	yds com (54")	sq ft col	com 1	col 2	3	4	5	6	7	8	9	10	11	12	13	14	15	L1	L2	L3
1810-CC	2.25	n/a	1,374	1,411	1,453	1,506	1,580	1,686	1,792	1,898	2,004	2,109	2,215	2,321	2,427	2,533	2,638	1,841	1,947	2,052

CHAIR/CHAIR/CHAIR TANDEM

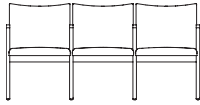

w	outside d	h	sw	seat sd	sh	seat to top of back	arm height	weight lbs.	cubic feet
65.5	25.25	32.5	20.25	20	17.5	15	25.5	69	34

model	yds com (54")	sq ft col	com 1	col 2	3	4	5	6	7	8	9	10	11	12	13	14	15	L1	L2	L3
1810-CCC	3.25	n/a	1,895	1,948	2,010	2,086	2,193	2,346	2,499	2,651	2,804	2,957	3,110	3,263	3,416	3,568	3,721	2,557	2,711	2,862

OPTIONS

Arm Caps	Finish	Removable Covers	Fabric 1
Standard X9 No Arm Cap	Selection Required	Standard X9 No Selection of Option	Selection Required
Resin \$50 per arm cap D1N Black D1M Taupe D1P Grey Solid Surface \$90 per arm CWS Cameo White MWS Modern White CSS Concrete DMS Deep Mink	See page 9 for full list of finish options	B1L Removable Seat Cover per seat \$98	Fabric: Grade, Vendor, Pattern, Color NOTE: For multiple fabric applications see page 14 for information and pricing

HOW TO ORDER

SPECIFY: Arm caps | wood finish | removable covers | textile pattern and color. See pages 5-14 for information and options on moisture barrier, CAL133, upholstery applications, a complete offering of finishes and ordering details.

MODEL NUMBER

1810-CC

Arm Caps	Finish	Removable Covers	Fabric 1
D1N	MLC	B1L	Grade 5, Momentum, Row, Breeze

REIN+ GANGING TABLE STANDARD FEATURES

- European Beech Hardwood Frame
- Mortise-and-Tenon Construction
- Top Options - Veneer, HPL or TFL with Matching PVC Edge, 3DL or Solid Surface
- Wall-Saver Design
- Non-Marring Adjustable Glides
- Can be Ganged to other Rein+ Units using 1810-G or 1810-TG

INSIDE 90° TABLE

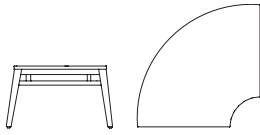

model		w	d	h	wt	cu ft	list
1810-90I	VENEER	30.25	30.25	14.5	52	10	\$ 724
	TFL/HPL/3DL						\$ 798
	STUDIO TFL/HPL/3DL						\$ 879
	SOLID SURFACE						\$ 895

OUTSIDE 90° TABLE

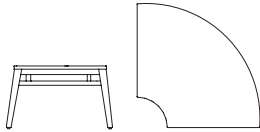

model		w	d	h	wt	cu ft	list
1810-90O	VENEER	30.25	30.25	14.5	52	10	\$ 724
	TFL/HPL/3DL						\$ 798
	STUDIO TFL/HPL/3DL						\$ 879
	SOLID SURFACE						\$ 895

END/MIDDLE TABLE

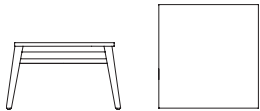

model		w	d	h	wt	cu ft	list
1810-E	VENEER	22.5	25	14.5	41	7	\$ 567
	TFL/HPL/3DL						\$ 644
	STUDIO TFL/HPL/3DL						\$ 709
	SOLID SURFACE						\$ 752

OPTIONS

Exposed Wood Finish	Top	Spill Groove
Selection Required	Standard	Selection Required
See page 9 for full list of finish options	X9 Veneer Match to Exposed Wood Finish	Available only on 3DL and Solid Surface
	HPL (Matching PVC Edge) TFL (Matching PVC Edge) 3DL Solid Surface	X9 None C6H Spill Groove
	See pages 9-10 for full list of HPL, TFL, 3DL and Solid Surface options	

HOW TO ORDER

SPECIFY: Base - Wood finish | Top - Veneer finish, HPL, TFL, 3DL or solid surface | spill groove. See pages 5-14 for a complete offering of finishes and ordering details.

MODEL NUMBER

1810-90I

Exposed Wood Finish	Top	Spill Groove
MNW	NWP	X9

REIN+ GANGING CLIPS STANDARD FEATURES

- Black Powder Coated Metal
- Tightens onto Understructure using Two Wing Nut Bolts (included)

CHAIR GANGING BRACKET



model	w	d	h	wt	cu ft	list
1810-G	2.5	25	1.25	0.02	0.04	\$ 27

TABLE GANGING BRACKET

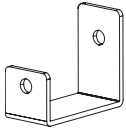

model	w	d	h	wt	cu ft	list
1810-TG	2.5	25	1.25	0.02	0.04	\$ 27

HOW TO ORDER

MODEL NUMBER

1810-G

RULE OF THREE MULTIPLE SEATING STANDARD FEATURES

- 3/4" Tubular Bent Luster Grey Powder Coated Metal Frame
- Black Resin Arm Cap
- Upholstered Seat and Back
- Spring Seat Construction
- Clean-Thru Design
- Wall-Saver Design
- Tight Cushion
- White Plastic Glide fitted into the Bottom of Tubular Leg
- Field Replaceable Components

BASE CHAIR



w	outside d	h	sw	seat sd	sh	seat to top of back	arm height	weight lbs.	cubic feet
27	25	31.75	21.25	18.5	18.5	13.5	25.5	35	27

model	yds com (54")	sq ft col	com 1	col 2	3	4	5	6	7	8	9	10	11	12	13	14	15	L1	L2	L3
1392-C	1.5	n/a	817	842	870	905	955	1,025	1,096	1,166	1,237	1,307	1,378	1,448	1,519	1,589	1,660	1,137	1,209	1,278

BASE LOVESEAT

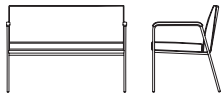

w	outside d	h	sw	seat sd	sh	seat to top of back	arm height	weight lbs.	cubic feet
43.75	25	31.75	41.5	18.5	18.5	13.5	25.5	62	33

model	yds com (54")	sq ft col	com 1	col 2	3	4	5	6	7	8	9	10	11	12	13	14	15	L1	L2	L3
1392-2	2.5	n/a	1,319	1,360	1,407	1,466	1,548	1,666	1,783	1,901	2,018	2,136	2,254	2,371	2,489	2,606	2,724	1,834	1,953	2,069

BARIATRIC BASE CHAIR



w	outside d	h	sw	seat sd	sh	seat to top of back	arm height	weight lbs.	cubic feet
32.25	25	31.75	30	18.5	18.5	13.5	25.5	38	33

model	yds com (54")	sq ft col	com 1	col 2	3	4	5	6	7	8	9	10	11	12	13	14	15	L1	L2	L3
1392-OB	2	n/a	1,138	1,171	1,209	1,256	1,321	1,415	1,509	1,604	1,698	1,792	1,886	1,980	2,074	2,168	2,262	1,556	1,651	1,744

OPTIONS

Arm Caps	Powder Coat	Removable Covers	Fabric 1
Standard DIN Black Resin	Standard MSL Luster Grey	Standard X9 No Selection of Option	Selection Required
A3 Wood (specify finish) \$74 pair	BWT Bone White BUFF Buff CHLK Chalk SGLD Gold GRPH Graphite MSL Luster Grey HIP Oiled Bronze BKO Onyx POLR Polar SBRZ Soft Bronze HIF Warm Grey	H7 Removable Seat and Back Covers \$196 B1L Removable Seat Cover only \$98 B1M Removable Back Cover only \$98	Fabric: Grade, Vendor, Pattern, Color NOTE: For multiple fabric applications see page 14 for information and pricing

HOW TO ORDER

SPECIFY: Arm caps | arm cap finish (if applicable) | powder coat | removable covers | textile pattern and color. See pages 5-14 for information and options on moisture barrier, CAL133, upholstery applications, a complete offering of finishes and ordering details.

MODEL NUMBER

1392-C

Arm Caps	Powder Coat	Removable Covers	Fabric 1
A3 - MNW	MSL	H7	Grade 5, Momentum, Row, Breeze

RULE OF THREE MULTIPLE SEATING STANDARD FEATURES

- 3/4" Tubular Bent Luster Grey Powder Coated Metal Frame
- Black Resin Arm Cap
- Upholstered Seat and Back
- Spring Seat Construction
- Clean-Thru Design
- Wall-Saver Design
- Tight Cushion
- White Plastic Glide fitted into the Bottom of Tubular Leg
- Field Replaceable Components

ADD ON CHAIR



w	outside d	h	sw	seat sd	sh	seat to top of back	arm height	weight lbs.	cubic feet
22.25	25	31.75	21.25	18.5	18.5	13.5	25.5	35	19

model	yds com (54")	sq ft col	com 1	col 2	3	4	5	6	7	8	9	10	11	12	13	14	15	L1	L2	L3
1392-A	1.5	n/a	710	735	763	798	848	918	989	1,059	1,130	1,200	1,271	1,341	1,412	1,482	1,553	1,030	1,102	1,171

LOVESEAT ADD ON



w	outside d	h	sw	seat sd	sh	seat to top of back	arm height	weight lbs.	cubic feet
42.75	25	31.75	41.5	28.5	18.5	13.5	25.5	60	33

model	yds com (54")	sq ft col	com 1	col 2	3	4	5	6	7	8	9	10	11	12	13	14	15	L1	L2	L3
1392-2A	2.5	n/a	1,223	1,264	1,311	1,370	1,452	1,570	1,687	1,805	1,922	2,040	2,158	2,275	2,393	2,510	2,628	1,738	1,857	1,973

BARIATRIC ADD ON CHAIR



w	outside d	h	sw	seat sd	sh	seat to top of back	arm height	weight lbs.	cubic feet
31.25	25	31.75	30	18.5	18.5	13.5	25.5	38	33

model	yds com (54")	sq ft col	com 1	col 2	3	4	5	6	7	8	9	10	11	12	13	14	15	L1	L2	L3
1392-OBA	2	n/a	1,036	1,069	1,107	1,154	1,219	1,313	1,407	1,502	1,596	1,690	1,784	1,878	1,972	2,066	2,160	1,454	1,549	1,642

OPTIONS

Arm Caps	Powder Coat	Removable Covers	Fabric 1
Standard DIN Black Resin	Standard MSL Luster Grey	Standard X9 No Selection of Option	Selection Required
A3 Wood (specify finish) \$37 per arm cap	BWT Bone White BUFF Buff CHLK Chalk SGLD Gold GRPH Graphite MSL Luster Grey HIP Oiled Bronze BKO Onyx POLR Polar SBRZ Soft Bronze HIF Warm Grey	H7 Removable Seat and Back Covers \$196 B1L Removable Seat Cover only \$98 B1M Removable Back Cover only \$98	Fabric: Grade, Vendor, Pattern, Color NOTE: For multiple fabric applications see page 14 for information and pricing

HOW TO ORDER

SPECIFY: Arm caps | arm cap finish (if applicable) | powder coat | removable covers | textile pattern and color. See pages 5-14 for information and options on moisture barrier, CAL133, upholstery applications, a complete offering of finishes and ordering details.

MODEL NUMBER			
1392-A			
Arm Caps	Powder Coat	Removable Covers	Fabric 1
A3 - MNW	MSL	H7	Grade 5, Momentum, Row, Breeze

RULE OF THREE GANGING TABLES STANDARD FEATURES

- Top Options - European Beech Veneer, 3DL or Solid Surface
- Field Replaceable Components
- White Plastic Glide fitted into the Bottom of Tubular Leg on 1392-E
- Non-Marring Adjustable Glides on 1392-E
- 3/4" Tubular Bent Luster Grey Powder Coated Metal Frame on 1392-E

MIDDLE TABLE

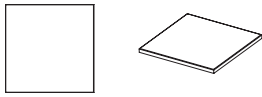

model		w	d	h	wt	cu ft	list
1392-M	VENEER	21	21	16.25	20	15	\$ 424
	SOLID SURFACE						\$ 797
	3DL						\$ 442

90 DEGREE TABLE

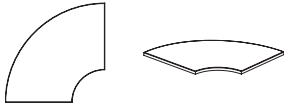

model		w	d	h	wt	cu ft	list
1392-90	VENEER	44	21	16.25	20	13	\$ 634
	SOLID SURFACE						\$ 1,285
	3DL						\$ 613

END TABLE

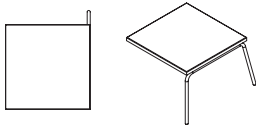

model		w	d	h	wt	cu ft	list
1392-E	VENEER	21	21	16.25	20	15	\$ 530
	SOLID SURFACE						\$ 857
	3DL						\$ 522

OPTIONS

Powder Coat (1392-E only)	Top	Spill Groove
Standard MSL Luster Grey	Selection Required	Selection Required Available only on 3DL and Solid Surface
BWT Bone White BUFF Buff CHLK Chalk SGLD Gold GRPH Graphite MSL Luster Grey HIP Oiled Bronze BKO Onyx POLR Polar SBRZ Soft Bronze HIF Warm Grey	Veneer (Matching Edge) 3DL Solid Surface See page 9 for full list of finish, 3DL and Solid Surface options	X9 None C6H Spill Groove

HOW TO ORDER

SPECIFY: Base - Powder coat | Top - Veneer finish, 3DL or solid surface | spill groove. See pages 5-14 for a complete offering of finishes and ordering details.

MODEL NUMBER

1392-E

Powder Coat (1392-E only)	Top	Spill Groove
BWT	BSQ	X9

SERONY PATIENT STANDARD FEATURES

- Upholstered Seat and Back
- Clean-Thru Design
- Wall-Saver Design
- Tight Cushion
- Luster Grey Powder Coat on all Exposed Metal
- Black Poly Arm Caps
- Non-Marring Adjustable Glides

BASE CHAIR

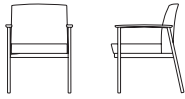

w	outside			sw	seat			seat to top of back	arm height	weight lbs.	cubic feet
	d	h	sd		sh						
25	26	33	21.5	20	18	15.25	25	45	19		

model	yds com (54")	sq ft col	com 1	col 2	3	4	5	6	7	8	9	10	11	12	13	14	15	L1	L2	L3
1472-C	1.5	n/a	896	921	949	984	1,034	1,104	1,175	1,245	1,316	1,386	1,474	1,527	1,598	1,668	1,739	1,216	1,288	1,357

BASE LOVESEAT

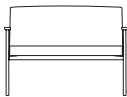

w	outside			sw	seat			seat to top of back	arm height	weight lbs.	cubic feet
	d	h	sd		sh						
45	26	33	42.25	20	18	15.25	25	70	33		

model	yds com (54")	sq ft col	com 1	col 2	3	4	5	6	7	8	9	10	11	12	13	14	15	L1	L2	L3
1472-2	2.5	n/a	1,525	1,566	1,613	1,672	1,754	1,872	1,989	2,107	2,224	2,342	2,460	2,577	2,695	2,812	2,930	2,040	2,159	2,275

BASE BARIATRIC



w	outside			sw	seat			seat to top of back	arm height	weight lbs.	cubic feet
	d	h	sd		sh						
34	26	33	30	20	18	15.25	25	58	26		

model	yds com (54")	sq ft col	com 1	col 2	3	4	5	6	7	8	9	10	11	12	13	14	15	L1	L2	L3
1472-OB	2	n/a	1,145	1,178	1,216	1,263	1,328	1,422	1,516	1,611	1,705	1,799	1,893	1,987	2,081	2,175	2,269	1,563	1,658	1,751

OPTIONS

Arm Caps	Powder Coat	Fabric 1
Standard D1N Black Poly	Standard MSL Luster Grey	Selection Required
D1M Taupe Poly D1P Grey Poly A3 Wood (specify finish) Solid Surface \$220 pair CWS Cameo White MWS Modern White CSS Concrete DMS Deep Mink	BWT Bone White BUFF Buff CHLK Chalk SGLD Gold GRPH Graphite MSL Luster Grey HIP Oiled Bronze BKO Onyx POLR Polar SBRZ Soft Bronze HIF Warm Grey	Fabric : Grade, Vendor, Pattern, Color NOTE: For multiple fabric applications see page 14 for information and pricing

HOW TO ORDER

SPECIFY: Arm Caps | arm cap finish (if applicable) | powder coat | textile pattern and color. See pages 5-14 for information and options on moisture barrier, CAL133, upholstery applications, a complete offering of finishes and ordering details.

MODEL NUMBER

1472-C

Arm Caps	Legs	Fabric 2
D1N	MSL	Grade 5, Momentum, Row, Breeze

SERONY MULTIPLE STANDARD FEATURES

- Upholstered Seat and Back
- Clean-Thru Design
- Wall-Saver Design
- Tight Cushion
- Luster Grey Powder Coat on all Exposed Metal
- Poly Arm Caps (specify color)
- Non-Marring Adjustable Glides

BASE CHAIR

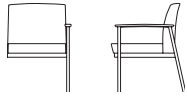

w	outside			sw	seat			seat to top of back	arm height	weight lbs.	cubic feet
	d	h	h		sd	sh					
23.25	26	33		21.5	20	18	15.25	25	38	19	

model	yds com (54")	sq ft col	com 1	col 2	3	4	5	6	7	8	9	10	11	12	13	14	15	L1	L2	L3
1472-A	1.5	n/a	795	820	848	883	933	1,003	1,074	1,144	1,215	1,285	1,356	1,426	1,497	1,567	1,638	1,115	1,187	1,256

BASE LOVESEAT



w	outside			sw	seat			seat to top of back	arm height	weight lbs.	cubic feet
	d	h	h		sd	sh					
43.75	26	33		42.25	20	18	15.25	25	62	33	

model	yds com (54")	sq ft col	com 1	col 2	3	4	5	6	7	8	9	10	11	12	13	14	15	L1	L2	L3
1472-2A	2.5	n/a	1,418	1,459	1,506	1,565	1,647	1,765	1,882	2,000	2,117	2,235	2,353	2,470	2,588	2,705	2,823	1,933	2,052	2,168

BASE BARIATRIC



w	outside			sw	seat			seat to top of back	arm height	weight lbs.	cubic feet
	d	h	h		sd	sh					
32	26	33		30	20	18	15.25	25	50	26	

model	yds com (54")	sq ft col	com 1	col 2	3	4	5	6	7	8	9	10	11	12	13	14	15	L1	L2	L3
1472-OBA	2	n/a	1,042	1,075	1,113	1,160	1,225	1,319	1,413	1,508	1,602	1,696	1,790	1,884	1,978	2,072	2,166	1,460	1,555	1,648

OPTIONS

Arm Caps	Powder Coat	Fabric 1
Standard D1N Black Poly	Standard MSL Luster Grey	Selection Required
D1M Taupe Poly D1P Grey Poly	BWT Bone White BUFF Buff CHLK Chalk SGLD Gold GRPH Graphite MSL Luster Grey HIP Oiled Bronze BKO Onyx POLR Polar SBRZ Soft Bronze HIF Warm Grey	Fabric : Grade, Vendor, Pattern, Color NOTE: For multiple fabric applications see page 14 for information and pricing
A3 Wood (specify finish) Solid Surface \$110 per arm CWS Cameo White MWS Modern White CSS Concrete DMS Deep Mink		

HOW TO ORDER

SPECIFY: Arm Caps | arm cap finish (if applicable) | powder coat | textile pattern and color. See pages 5-14 for information and options on moisture barrier, CAL133, upholstery applications, a complete offering of finishes and ordering details.

MODEL NUMBER

1472-A

Arm Caps	Powder Coat	Fabric 1
D1N	MSL	Grade 5, Momentum, Row, Breeze

SERONY GANGING TABLE STANDARD FEATURES

- European Beech Exposed Wood
- Top Options - Veneer, HPL or TFL with Matching PVC Edge
- Luster Grey Powder Coat on all Exposed Metal
- Non-Marring Adjustable Glides on 1471-E

MIDDLE TABLE



model	w	d	h	wt	cu ft	list
1472-M	21	23	16.5	20	15	\$ 574

END TABLE

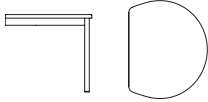

model	w	d	h	wt	cu ft	list
1472-E	23	19	16.5	25	15	\$ 747

CORNER 90° HANG TABLE

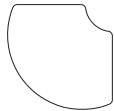

model	w	d	h	wt	cu ft	list
1472-90	28	28	16.5	25	15	\$ 703

OPTIONS

Powder Coat	Top
Standard	Selection Required
MSL Luster Grey	
BWT Bone White	Veneer (Matching Edge)
BUFF Buff	HPL (Matching Edge)
CHLK Chalk	TFL (Matching Edge)
SGLD Gold	
GRPH Graphite	See pages 9-10 for full list of finish. HPL and TFL options.
MSL Luster Grey	
HIP Oiled Bronze	
BKO Onyx	
POLR Polar	
SBRZ Soft Bronze	
HIF Warm Grey	

HOW TO ORDER

SPECIFY: Base - Powder coat | Top-Veneer finish, HPL or TFL. See pages 5-14 for a complete offering of finishes and ordering details.

MODEL NUMBER

1472-M

Powder Coat	Top
MSL	MNW

SILVR ION METAL MULTIPLE STANDARD FEATURES

- 1471-C rated for 400 lbs.
- 1471-OB rated for 500 lbs.
- Clean-Thru Design
- Upholstered Seat and Back
- European Beech Arm Caps
- Warm Grey (with Silver Ion Antimicrobial) Powder Coat on all Exposed Metal is Standard
- Wall-Saver Design
- Non-Marring Adjustable Glides

BASE CHAIR

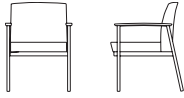

w	outside d	h	sw	seat sd	sh	seat to top of back	arm height	weight lbs.	cubic feet
25	26	33	21	18.5	19	14.25	25	60	20

model	yds com (54")	sq ft col	com 1	col 2	3	4	5	6	7	8	9	10	11	12	13	14	15	L1	L2	L3
1471-C	1.5	n/a	1,086	1,111	1,139	1,174	1,224	1,294	1,365	1,435	1,506	1,576	1,647	1,717	1,788	1,858	1,929	1,406	1,478	1,547

BASE LOVESEAT

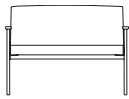

w	outside d	h	sw	seat sd	sh	seat to top of back	arm height	weight lbs.	cubic feet
48	26	33	41.25	18.5	19	14.25	25	85	46

model	yds com (54")	sq ft col	com 1	col 2	3	4	5	6	7	8	9	10	11	12	13	14	15	L1	L2	L3
1471-2	3	n/a	1,848	1,897	1,954	2,024	2,123	2,264	2,405	2,546	2,687	2,828	2,970	3,111	3,252	3,393	3,534	2,461	2,603	2,743

BASE BARIATRIC



w	outside d	h	sw	seat sd	sh	seat to top of back	arm height	weight lbs.	cubic feet
34.5	26	33	30	18.5	19	14.25	25	72	26

model	yds com (54")	sq ft col	com 1	col 2	3	4	5	6	7	8	9	10	11	12	13	14	15	L1	L2	L3
1471-OB	2	n/a	1,342	1,375	1,413	1,460	1,525	1,619	1,713	1,808	1,902	1,996	2,090	2,184	2,278	2,372	2,466	1,760	1,855	1,948

OPTIONS

Arm Caps	Powder Coat	Removable Covers	Fabric 1
Standard A3 Wood Arm Cap (specify finish)	Standard H1F Warm Grey (with Silver Ion Antimicrobial)	Standard X9 No Selection of Option	Selection Required
Poly Arm Caps D1N Black D1M Taupe D1P Grey	See page 9 for full list of powder coat options NOTE: Any other powder coat specified will not have Silver Ion antimicrobial technology	H7 Removable Seat and Back Covers \$196 B1L Removable Seat Cover only \$98 B1M Removable Back Cover only \$98	Fabric: Grade, Vendor, Pattern, Color NOTE: For multiple fabric applications see page 14 for information and pricing

HOW TO ORDER

SPECIFY: Arm caps | arm cap finish (if applicable) | powder coat | removable covers | textile pattern and color. See pages 5-14 for information and options on moisture barrier, CAL133, upholstery applications, a complete offering of finishes and ordering details.

MODEL NUMBER

1471-C

Arm Caps	Powder Coat	Removable Covers	Fabric 1
D1N	H1F	H7	Grade 5, Momentum, Row, Breeze

SILVR ION METAL MULTIPLE STANDARD FEATURES

- 1471-OBA rated for 500 lbs.
- Clean-Thru Design
- Upholstered Seat and Back
- European Beech Arm Caps
- Warm Grey (with Silver Ion Antimicrobial) Powder Coat on all Exposed Metal is Standard
- Wall-Saver Design
- Non-Marring Adjustable Glides

ADD ON CHAIR

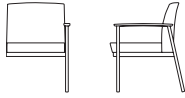

w	outside			sw	seat			seat to top of back	arm height	weight lbs.	cubic feet
	d	h			sd	sh					
23	26	33		21	18.5	19	14.25	25	60	21	

model	yds com (54")	sq ft col	com 1	col 2	3	4	5	6	7	8	9	10	11	12	13	14	15	L1	L2	L3
1471-A	1.5	n/a	963	988	1,016	1,051	1,101	1,171	1,242	1,312	1,383	1,453	1,524	1,594	1,665	1,735	1,806	1,283	1,355	1,424

ADD ON LOVESEAT



w	outside			sw	seat			seat to top of back	arm height	weight lbs.	cubic feet
	d	h			sd	sh					
46	26	33		41.25	18.5	19	14.25	25	85	46	

model	yds com (54")	sq ft col	com 1	col 2	3	4	5	6	7	8	9	10	11	12	13	14	15	L1	L2	L3
1471-2A	3	n/a	1,718	1,767	1,824	1,894	1,993	2,134	2,275	2,416	2,557	2,698	2,840	2,981	3,122	3,263	3,404	2,331	2,473	2,613

ADD ON BARIATRIC



w	outside			sw	seat			seat to top of back	arm height	weight lbs.	cubic feet
	d	h			sd	sh					
32	26	33		30	18.5	19	14.25	25	72	26	

model	yds com (54")	sq ft col	com 1	col 2	3	4	5	6	7	8	9	10	11	12	13	14	15	L1	L2	L3
1471-OBA	2	n/a	1,263	1,296	1,334	1,381	1,446	1,540	1,634	1,729	1,823	1,917	2,011	2,105	2,199	2,293	2,387	1,681	1,776	1,869

OPTIONS

Arm Caps	Powder Coat	Removable Covers	Fabric 1
Standard A3 Wood Arm Cap (specify finish)	Standard HIF Warm Grey (with Silver Ion Antimicrobial)	Standard X9 No Selection of Option	Selection Required
Poly Arm Caps DIN Black DIM Taupe DIP Grey	See page 9 for full list of powder coat options NOTE: Any other powder coat specified will not have Silver Ion antimicrobial technology	H7 Removable Seat and Back Covers \$196 B1L Removable Seat Cover only \$98 B1M Removable Back Cover only \$98	Fabric: Grade, Vendor, Pattern, Color NOTE: For multiple fabric applications see page 14 for information and pricing

HOW TO ORDER

SPECIFY: Arm caps | arm cap finish (if applicable) | powder coat | removable covers | textile pattern and color. See pages 5-14 for information and options on moisture barrier, CAL133, upholstery applications, a complete offering of finishes and ordering details.

MODEL NUMBER

1471-A

Arm Caps	Powder Coat	Removable Covers	Fabric 1
DIN	HIF	H7	Grade 5, Momentum, Row, Breeze

SILVR ION METAL GANGING TABLE STANDARD FEATURES

- European Beech Exposed Wood
- Top Options - Veneer, HPL or TFL with Matching PVC Edge
- Warm Grey (with Silver Ion Antimicrobial) Powder Coat on all Exposed Metal is Standard
- Non-Marring Adjustable Glides on 1471-E

MIDDLE TABLE



model	w	d	h	wt	cu ft	list
1471-M	21	23	16.5	20	15	\$ 591

END TABLE

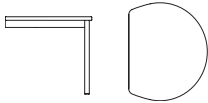

model	w	d	h	wt	cu ft	list
1471-E	23	19	16.5	25	15	\$ 769

CORNER 90° HANG TABLE



model	w	d	h	wt	cu ft	list
1471-90	28	28	16.5	25	15	\$ 724

OPTIONS

Powder Coat	Top
Standard	Selection Required
HIF Warm Grey (with Silver Ion Antimicrobial)	
See page 9 for full list of powder coat options	Veneer (Matching Edge) HPL (Matching PVC Edge) TFL (Matching PVC Edge)
NOTE: Any other powder coat specified will not have Silver Ion Antimicrobial technology	See pages 9-10 for full list of finish, HPL and TFL options

HOW TO ORDER

SPECIFY: Base - Powder coat | Top - Veneer finish, HPL or TFL. See pages 5-14 for a complete offering of finishes and ordering details.

MODEL NUMBER

1471-M

Powder Coat	Top
HIF	NWP

SILVR ION WOOD MULTIPLE STANDARD FEATURES

- 1441-C rated for 400 lbs.
- 1441-OB rated for 500 lbs.
- Clean-Thru Design
- Upholstered Seat and Back
- European Beech Arm Caps and Overlay on Legs
- Warm Grey (with Silver Ion Antimicrobial) Powder Coat on all Exposed Metal is Standard
- Wall-Saver Design
- Non-Marring Adjustable Glides

BASE CHAIR

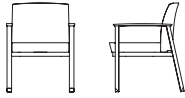

w	outside d	h	sw	seat sd	sh	seat to top of back	arm height	weight lbs.	cubic feet
25	26	33	21	18.5	19	14.25	25	60	20

model	yds com (54")	sq ft col	com 1	col 2	3	4	5	6	7	8	9	10	11	12	13	14	15	L1	L2	L3
1441-C	1.5	n/a	1,463	1,488	1,516	1,551	1,601	1,671	1,742	1,812	1,883	1,953	2,024	2,094	2,165	2,235	2,306	1,783	1,855	1,924

BASE LOVESEAT

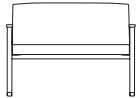

w	outside d	h	sw	seat sd	sh	seat to top of back	arm height	weight lbs.	cubic feet
48	26	33	41.25	18.5	19	14.25	25	85	46

model	yds com (54")	sq ft col	com 1	col 2	3	4	5	6	7	8	9	10	11	12	13	14	15	L1	L2	L3
1441-2	3	n/a	2,114	2,163	2,220	2,290	2,389	2,530	2,671	2,812	2,953	3,094	3,236	3,377	3,518	3,659	3,800	2,727	2,869	3,009

BASE BARIATRIC



w	outside d	h	sw	seat sd	sh	seat to top of back	arm height	weight lbs.	cubic feet
34.5	26	33	30	18.5	19	14.25	25	72	26

model	yds com (54")	sq ft col	com 1	col 2	3	4	5	6	7	8	9	10	11	12	13	14	15	L1	L2	L3
1441-OB	2	n/a	1,758	1,791	1,829	1,876	1,941	2,035	2,129	2,224	2,318	2,412	2,506	2,600	2,694	2,788	2,882	2,176	2,271	2,364

OPTIONS

Arm Caps	Finish	Powder Coat	Removable Covers	Arm Panels	Fabric 1
Standard A3 Wood Arm Cap	Selection Required	Standard H1F Warm Grey (with Silver Ion Antimicrobial)	Standard X9 No Selection of Option	Standard X9 No Selection of Option	Selection Required
Poly Arm Caps D1N Black D1M Taupe D1P Grey	See page 9 for full list of finish options	See page 9 for full list of powder coat options NOTE: Any other powder coat specified will not have Silver Ion antimicrobial technology	H7 Removable Seat and Back Covers \$196 B1L Removable Seat Cover only \$98 B1M Removable Back Cover only \$98	WAP Pair of Wood (specify finish) \$418 UAP Pair of Upholstered (specify textile) (see pricing below)	Fabric: Grade, Vendor, Pattern, Color NOTE: For multiple fabric applications see page 14 for information and pricing

Arm Panel Options Per Arm Pair

yds com (54")	sq ft col	com 1	col 2	3	4	5	6	7	8	9	10	11	12	13	14	15	L1	L2	L3
0.75	n/a	529	541	555	573	598	633	668	704	739	774	809	845	880	915	950	703	739	774

HOW TO ORDER

SPECIFY: Arm caps | wood finish | powder coat | removable covers | arm panels | textile pattern and color. See pages 5-14 for information and options on moisture barrier, CAL133, upholstery applications, a complete offering of finishes and ordering details.

MODEL NUMBER

1441-C

Arm Caps	Finish	Powder Coat	Removable Covers	Arm Panels	Fabric 1
D1N	MLC	H1F	B1L	WAP	Grade 5, Momentum, Row, Breeze

SILVR ION WOOD MULTIPLE STANDARD FEATURES

- 1441-OBA rated for 500 lbs.
- Clean-Thru Design
- Upholstered Seat and Back
- European Beech Arm Caps and Overlay on Legs
- Warm Grey (with Silver Ion Antimicrobial) Powder Coat on all Exposed Metal is Standard
- Wall-Saver Design
- Non-Marring Adjustable Glides

ADD ON CHAIR

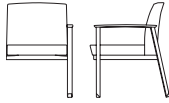

w	outside			sw	seat			seat to top of back	arm height	weight lbs.	cubic feet
	d	h			sd	sh					
23	26	33		21	18.5	19		14.25	25	60	20

model	yds com (54")	sq ft col	com 1	col 2	3	4	5	6	7	8	9	10	11	12	13	14	15	L1	L2	L3
1441-A	1.5	n/a	1,255	1,280	1,308	1,343	1,393	1,463	1,534	1,604	1,675	1,745	1,816	1,886	1,957	2,027	2,098	1,575	1,647	1,716

ADD ON LOVESEAT

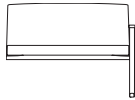

w	outside			sw	seat			seat to top of back	arm height	weight lbs.	cubic feet
	d	h			sd	sh					
46	26	33		41.25	18.5	19		14.25	25	85	46

model	yds com (54")	sq ft col	com 1	col 2	3	4	5	6	7	8	9	10	11	12	13	14	15	L1	L2	L3
1441-2A	3	n/a	1,853	1,902	1,959	2,029	2,128	2,269	2,410	2,551	2,692	2,833	2,975	3,116	3,257	3,398	3,539	2,466	2,608	2,748

ADD ON BARIATRIC

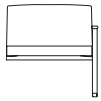

w	outside			sw	seat			seat to top of back	arm height	weight lbs.	cubic feet
	d	h			sd	sh					
32	26	33		30	18.5	19		14.25	25	72	26

model	yds com (54")	sq ft col	com 1	col 2	3	4	5	6	7	8	9	10	11	12	13	14	15	L1	L2	L3
1441-OBA	2	n/a	1,440	1,473	1,511	1,558	1,623	1,717	1,811	1,906	2,000	2,094	2,188	2,282	2,376	2,470	2,564	1,858	1,953	2,046

OPTIONS

Arm Caps	Finish	Powder Coat	Removable Covers	Arm Panels	Fabric 1
Standard A3 Wood Arm Cap	Selection Required	Standard H1F Warm Grey (with Silver Ion Antimicrobial)	Standard X9 No Selection of Option	Standard X9 No Selection of Option	Selection Required
Poly Arm Caps D1N Black D1M Taupe D1P Grey	See page 9 for full list of finish options	See page 9 for full list of powder coat options NOTE: Any other powder coat specified will not have Silver Ion antimicrobial technology	H7 Removable Seat and Back Covers \$196 B1L Removable Seat Cover only \$98 B1M Removable Back Cover only \$98	WAP Wood (specify finish) \$209 UAP Upholstered (specify textile) (see pricing below)	Fabric: Grade, Vendor, Pattern, Color NOTE: For multiple fabric applications see page 14 for information and pricing

Arm Panel Options Per Arm Panel

yds com (54")	sq ft col	com 1	col 2	3	4	5	6	7	8	9	10	11	12	13	14	15	L1	L2	L3
0.75	n/a	265	277	291	309	334	369	404	440	475	510	545	581	616	651	686	439	475	510

HOW TO ORDER

SPECIFY: Arm caps | wood finish | powder coat | removable covers | arm panels | textile pattern and color. See pages 5-14 for information and options on moisture barrier, CAL133, upholstery applications, a complete offering of finishes and ordering details.

MODEL NUMBER

1441-A

Arm Caps	Finish	Powder Coat	Removable Covers	Arm Panels	Fabric 1
D1N	MLC	H1F	B1L	WAP	Grade 5, Momentum, Row, Breeze

SILVR ION WOOD GANGING TABLE STANDARD FEATURES

- European Beech Exposed Wood
- Top Options - Veneer, HPL or TFL with Matching PVC Edge
- Warm Grey (with Silver Ion Antimicrobial) Powder Coat on all Exposed Metal is Standard
- European Beech Overlay on 1441-E
- Non-Marring Adjustable Glides on 1441-E

MIDDLE TABLE



model	w	d	h	wt	cu ft	list
1441-M	21	23	16.5	20	15	\$ 591

END TABLE

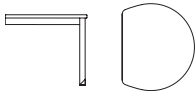

model	w	d	h	wt	cu ft	list
1441-E	23	19	16.5	25	15	\$ 800

CORNER 90° HANG TABLE



model	w	d	h	wt	cu ft	list
1441-90	28	28	16.5	25	15	\$ 724

OPTIONS

Exposed Wood Finish	Powder Coat	Top
Selection Required	Standard HIF Warm Grey (with Silver Ion Antimicrobial)	Standard X9 Veneer Match to Exposed Wood Finish
See page 9 for full list of finish options	See page 9 for full list of powder coat options NOTE: Any other powder coat specified will not have Silver Ion Antimicrobial technology	HPL (Matching PVC Edge) TFL (Matching PVC Edge) See pages 9-10 for full list of finish, HPL and TFL options

HOW TO ORDER

SPECIFY: Base - Wood finish | powder coat | Top - Veneer finish, HPL or TFL. See pages 5-14 for a complete offering of finishes and ordering details.

MODEL NUMBER

1441-M

Exposed Wood Finish	Powder Coat	Top
MNW	HIF	X9

VOYAGE MULTIPLE STANDARD FEATURES

- 1520-OB rated for 500 lbs.
- Clean-Thru Design
- Upholstered Seat and Back
- Field Replaceable Components
- European Beech Exposed Wood Frame
- Wall-Saver Design
- Non-Marring Adjustable Glides

BASE CHAIR

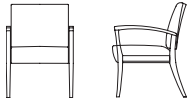

w	outside			sw	seat			seat to top of back	arm height	weight lbs.	cubic feet
	d	h			sd	sh					
24	26.5	34		21	19.5	17	17	25.5	40	19	

model	yds com (54")	sq ft col	com 1	col 2	3	4	5	6	7	8	9	10	11	12	13	14	15	L1	L2	L3
1520-C	1.5	n/a	1,014	1,039	1,067	1,102	1,152	1,222	1,293	1,363	1,434	1,504	1,575	1,645	1,716	1,786	1,857	1,334	1,406	1,475

BASE LOVESEAT

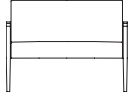

w	outside			sw	seat			seat to top of back	arm height	weight lbs.	cubic feet
	d	h			sd	sh					
44.25	26.5	34		40.75	19.5	17	17	25.5	70	35	

model	yds com (54")	sq ft col	com 1	col 2	3	4	5	6	7	8	9	10	11	12	13	14	15	L1	L2	L3
1520-2	2.75	n/a	1,531	1,576	1,628	1,693	1,783	1,912	2,042	2,171	2,300	2,430	2,559	2,688	2,818	2,947	3,076	2,095	2,226	2,354

BASE BARIATRIC



w	outside			sw	seat			seat to top of back	arm height	weight lbs.	cubic feet
	d	h			sd	sh					
33	26.5	34		30	19.5	17	17	25.5	55	28	

model	yds com (54")	sq ft col	com 1	col 2	3	4	5	6	7	8	9	10	11	12	13	14	15	L1	L2	L3
1520-OB	2	n/a	1,303	1,336	1,374	1,421	1,486	1,580	1,674	1,769	1,863	1,957	2,051	2,145	2,239	2,333	2,427	1,721	1,816	1,909

OPTIONS

Arm Caps	Finish	Removable Covers	Fabric 1
Standard	Selection Required	Standard	Selection Required
X9 No Arm Cap		X9 No Selection of Option	
A4 Poly (black) \$185 pair	See page 9 for full list of finish options	H7 Removable Seat and Back Covers \$196 B1L Removable Seat Cover only \$98 B1M Removable Back Cover only \$98	Fabric: Grade, Vendor, Pattern, Color NOTE: For multiple fabric applications see page 14 for information and pricing

HOW TO ORDER

SPECIFY: Arm caps | wood finish | removable covers | textile pattern and color. See pages 5-14 for information and options on moisture barrier, CAL133, upholstery applications, a complete offering of finishes and ordering details.

MODEL NUMBER

1520-C

Arm Caps	Finish	Removable Covers	Fabric 1
A4	MLC	H7	Grade 5, Momentum, Row, Breeze

VOYAGE MULTIPLE STANDARD FEATURES

- 1520-OBA rated for 500 lbs.
- Clean-Thru Design
- Upholstered Seat and Back
- Field Replaceable Components
- European Beech Exposed Wood Frame
- Wall-Saver Design
- Non-Marring Adjustable Glides

ADD ON CHAIR

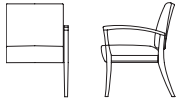

w	outside			sw	seat			seat to top of back	arm height	weight lbs.	cubic feet
	d	h			sd	sh					
22.5	26.5	34		21	19.5	17	17	25.5	40	19	

model	yds com (54")	sq ft col	com 1	col 2	3	4	5	6	7	8	9	10	11	12	13	14	15	L1	L2	L3
1520-A	1.5	n/a	876	901	929	964	1,014	1,084	1,155	1,225	1,296	1,366	1,437	1,507	1,578	1,648	1,719	1,196	1,268	1,337

ADD ON LOVESEAT

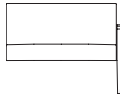

w	outside			sw	seat			seat to top of back	arm height	weight lbs.	cubic feet
	d	h			sd	sh					
42.75	26.5	34		40.75	19.5	17	17	25.5	70	35	

model	yds com (54")	sq ft col	com 1	col 2	3	4	5	6	7	8	9	10	11	12	13	14	15	L1	L2	L3
1520-2A	2.75	n/a	1,380	1,425	1,477	1,542	1,632	1,761	1,891	2,020	2,149	2,279	2,408	2,537	2,667	2,796	2,925	1,944	2,075	2,203

ADD ON BARIATRIC



w	outside			sw	seat			seat to top of back	arm height	weight lbs.	cubic feet
	d	h			sd	sh					
31.5	26.5	34		30	19.5	17	17	25.5	55	28	

model	yds com (54")	sq ft col	com 1	col 2	3	4	5	6	7	8	9	10	11	12	13	14	15	L1	L2	L3
1520-OBA	2	n/a	1,154	1,187	1,225	1,272	1,337	1,431	1,525	1,620	1,714	1,808	1,902	1,996	2,090	2,184	2,278	1,572	1,667	1,760

OPTIONS

Arm Caps	Finish	Removable Covers	Fabric 1
Standard X9 No Arm Cap	Selection Required	Standard X9 No Selection of Option	Selection Required
A4 Poly (black) \$93 per arm cap	See page 9 for full list of finish options	H7 Removable Seat and Back Covers \$196 B1L Removable Seat Cover only \$98 B1M Removable Back Cover only \$98	Fabric: Grade, Vendor, Pattern, Color NOTE: For multiple fabric applications see page 14 for information and pricing

HOW TO ORDER

SPECIFY: Arm caps | wood finish | removable covers | textile pattern and color. See pages 5-14 for information and options on moisture barrier, CAL133, upholstery applications, a complete offering of finishes and ordering details.

MODEL NUMBER

1520-C

Arm Caps	Finish	Removable Covers	Fabric 1
A4	MLC	H7	Grade 5, Momentum, Row, Breeze

VOYAGE GANGING TABLE STANDARD FEATURES

- European Beech Exposed Wood
- Top Options - Veneer or HPL with Matching PVC Edge
- Non-Marring Adjustable Glides on 1520-E

MIDDLE TABLE



model	w	d	h	wt	cu ft	list
1520-M	21	20	15	20	15	\$ 373

END TABLE



model	w	d	h	wt	cu ft	list
1520-E	23	20.25	15	20	16	\$ 535

CORNER 45° HANG TABLE



model	w	d	h	wt	cu ft	list
1520-45	21.75	20.75	15	20	13	\$ 543

CORNER 90° HANG TABLE

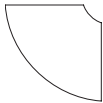

model	w	d	h	wt	cu ft	list
1520-90	35.25	20.75	15	20	13	\$ 661

OPTIONS

Exposed Wood Finish	Top
Selection Required	Standard X9 Veneer Match to Exposed Wood Finish
See page 9 for full list of finish options	HPL (Matching PVC Edge) See page 10 for full list of HPL options

HOW TO ORDER

SPECIFY: Base - Wood finish | Top - Veneer finish or HPL. See pages 5-14 for a complete offering of finishes and ordering details.

MODEL NUMBER

1520-E

Exposed Wood Finish	Top
MNW	NWP

EXAM STOOL STANDARD FEATURES

- Height Adjustable
- Pneumatic Lift
- Easy-Glide Casters
- Black Polyurethane Base

EXAM STOOL



w	outside			seat diameter			adjustable seat height	footring diameter	arm height	weight lbs.	cubic feet
	d	h	sw	sd	sh						
26	26	20	15	18.5	20	20-27.5	18	n/a	17	22	

model	yds com (54")	sq ft col	com 1	col 2	3	4	5	6	7	8	9	10	11	12	13	14	15	L1	L2	L3
2400	0.5	n/a	398	406	416	427	444	467	491	514	538	561	585	608	632	655	679	524	547	570

OPTIONS

Fabric 1

Selection Required

Fabric: Grade, Vendor, Pattern, Color

NOTE: For multiple fabric applications see page 14 for information and pricing

HOW TO ORDER

SPECIFY: Textile pattern and color. See pages 5-14 for information and options on moisture barrier, CAL133, upholstery applications, a complete offering of finishes and ordering details.

MODEL NUMBER

2400

Fabric 1

Grade 5, Momentum, Row, Breeze

STOOLS STANDARD FEATURES

- Fully Upholstered Seat and Back
- Nylon Glides
- All Styles Rated up to 300 lbs.
- Bar Height
- Clean-Thru Design

ARMLESS

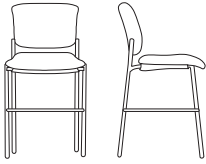

w	outside d	h	sw	seat sd	sh	inside back	arm height	from floor	weight lbs.	cubic feet
22.75	26	45	16.5	18.25	30.5	14.5	n/a	n/a	39	24

- Armless

model	yds com (54")	sq ft col	com 1	col 2	3	4	5	6	7	8	9	10	11	12	13	14	15	L1	L2	L3
C2322	1.5	30	600	625	653	688	738	808	879	949	1,020	1,090	1,161	1,231	1,302	1,372	1,443	920	992	1,061

ARMS

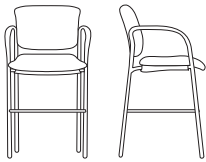

w	outside d	h	sw	seat sd	sh	inside back	arm height	from floor	weight lbs.	cubic feet
24	26	45	16.5	18.25	30.5	14.5	n/a	n/a	n/a	24



fixed black arms (BA) 8.5 36.5 42

fixed silver arms (SA) 8.5 36.5 42

- Fixed Arms

model	yds com (54")	sq ft col	com 1	col 2	3	4	5	6	7	8	9	10	11	12	13	14	15	L1	L2	L3
C2319	1.5	30	675	700	728	763	813	883	954	1,024	1,095	1,165	1,236	1,306	1,377	1,447	1,518	995	1,067	1,136

OPTIONS

Frame	Arms (C2319 Only)	Glides	Book Rack	Seat Foam	Fabric 1	Fabric 2
BF Black SF Silver	 BA Fixed Black Arms - Standard  SA Fixed Silver Arms \$32	W26 High Glides - Standard W34 Silver High Glides \$32	X9 None - Standard BR1 Book Rack \$79	X9 No Arms - Standard AFI 1" Additional Seat Foam \$41 NOTE: Add additional 10% for COM.	Grade, Vendor, Pattern, Color	Grade, Vendor, Pattern, Color

HOW TO ORDER

SPECIFY: Frame | arms | glides | book rack | seat foam | fabric 1 | fabric 2
See pages 5-14 for information and options on moisture barrier, CAL133, upholstery applications.

MODEL NUMBER

C2322

Frame	Arms (C2319 Only)	Glides	Book Rack	Seat Foam	Fabric 1	Fabric 2
BF	BA	W26	X9	X9	Grade 3, Momentum, Hue, Smoke	Grade 3, Momentum, Epic, Limestone

STOOLS STANDARD FEATURES

- Chrome Frame
 - Armless
 - Basic Task Control
 - 20" Foot Ring
 - Black Nylon Base
 - Casters
 - All Styles Rated up to 300 lbs.
- NOTE: Add \$80 List for each fully assembled chair in carton.

PLASTIC BACK MID / COUNTER HEIGHT



	w	outside d	h	sw	seat sd	sh	inside back	arm height	from floor	weight lbs.	cubic feet
G5 plastic	26	26	33/40.5	17.75	18	18.5/26	16	n/a	n/a	34.6	12.75
G5 uph.	26	26	33/40.5	17.75	18	19/26.5	16	n/a	n/a	34.6	12.75
G6 plastic	26	26	36.5/46.5	17.75	18	22/31.75	16	n/a	n/a	35.6	12.75
G6 uph.	26	26	36.5/46.5	17.75	18	22.5/32.25	16	n/a	n/a	35.6	12.75

- Nine plastic colors

model	yds com (54")	sq ft col	com 1	col 2	3	4	5	6	7	8	9	10	11	12	13	14	15	L1	L2	L3
Upholstered Seat with Plastic Back																				
432	1	17.5	572	588	607	631	664	711	758	805	852	899	946	993	1,040	1,087	1,134	795	842	889

list

Plastic Seat and Back \$ 482

MESH BACK MID / COUNTER HEIGHT



	w	outside d	h	sw	seat sd	sh	inside back	arm height	from floor	weight lbs.	cubic feet
G5 plastic	26	26	32/39.5	17.75	18	18.5/26	15	n/a	n/a	33.6	12.75
G5 uph.	26	26	32/39.5	17.75	18	19/26.5	15	n/a	n/a	33.6	12.75
G6 plastic	26	26	35.5/45.5	17.75	18	22/31.75	15	n/a	n/a	34.6	12.75
G6 uph.	26	26	35.5/45.5	17.75	18	22.5/32.25	15	n/a	n/a	34.6	12.75

- Three mesh back colors

model	yds com (54")	sq ft col	com 1	col 2	3	4	5	6	7	8	9	10	11	12	13	14	15	L1	L2	L3
Upholstered Seat with Mesh Back																				
432M	1	17.5	625	641	660	684	717	764	811	858	905	952	999	1,046	1,093	1,140	1,187	848	895	942

list

Plastic Seat \$ 535

OPTIONS

Cylinder	Base	Casters/Glides	Plastic	Mesh Back (432M Only)	Seat Material	Fabric/Grade
G5 Mid Height (8") G6 Counter Height (10")	B11 Black Nylon - Standard B12 Polished Aluminum \$100	W24 Hard Wheel Casters - Standard W25 Soft Wheel Casters \$30 W6 2 1/4" High Glides \$30	BAT Battleship BLK Black BRD Bordeaux CHN Chestnut DPB Deep Blue SAG Sage SND Sand SLT Slate WHT White	MBK Black MDG Dark Gray MSL Silver	Plastic Upholstered	Fabric: Grade, Vendor, Pattern, Color NOTE: For multiple fabric applications see page 14 for information and pricing

HOW TO ORDER

SPECIFY: Cylinder | base | casters/glides | plastic | mesh back | textile pattern and color.
See pages 5-14 for information and options on moisture barrier, CAL133, upholstery applications

MODEL NUMBER

432

Cylinder	Base	Casters/Glides	Plastic	Mesh Back (432M Only)	Seat Material	Fabric/Grade
G5	B11	W24	BAT		Upholstered	Grade 3, Momentum, Hue, Smoke

STOOL STANDARD FEATURES

- Chrome Frame
- 20" Foot Ring
- All Styles Rated up to 300 lbs.
- Armless
- Black Nylon Base
- NOTE: Add \$80 List for each fully assembled chair in carton.
- T4 Basic Task Control
- Casters

UPHOLSTERED BACK AND SEAT MID / COUNTER HEIGHT



	w	outside d	h	sw	seat sd	sh	inside back	arm height	from floor	weight lbs.	cubic feet
G5 uph.	26	26	33/40.5	17.75	18	19/26.5	16	n/a	n/a	38.8	12.75
G6 uph.	26	26	36.5/46.5	17.75	18	22.5/32.25	16	n/a	n/a	39.8	12.75

• Black plastic is standard on upholstered seats and backs unless otherwise specified.

model	yds com (54")	sq ft col	com 1	col 2	3	4	5	6	7	8	9	10	11	12	13	14	15	L1	L2	L3
432UB	1	29	623	639	658	682	715	762	809	856	903	950	997	1,044	1,091	1,138	1,185	846	893	940

OPTIONS

Cylinder	Base	Casters/Glides	Plastic	Fabric/Grade
G5 Mid Height (8") G6 Counter Height (10")	B11 Black Nylon - Standard B12 Polished Aluminum \$100	W24 Hard Wheel Casters - Standard W25 Soft Wheel Casters \$30 W6 2 1/4" High Glides \$30	BAT Battleship BLK Black BRD Bordeaux CHN Chestnut DPB Deep Blue SAG Sage SND Sand SLT Slate WHT White	Fabric: Grade, Vendor, Pattern, Color NOTE: For multiple fabric applications see page 14 for information and pricing

HOW TO ORDER

SPECIFY: Cylinder | base | casters/glides | plastic | textile pattern and color.
See pages 5-14 for information and options on moisture barrier, CAL133, upholstery applications

MODEL NUMBER

432UB

Cylinder	Base	Casters/Glides	Plastic	Fabric/Grade
G5	B11	W24	BAT	Grade 3, Momentum, Hue, Smoke

STOOLS STANDARD FEATURES

- Chrome Frame
 - Fixed Arm
 - Basic Task Control
 - 20" Foot Ring
 - Black Nylon Base
 - Casters
 - All Styles Rated up to 300 lbs.
- NOTE: Add \$80 List for each fully assembled chair in carton.

PLASTIC BACK MID / COUNTER HEIGHT



	w	outside d	h	sw	seat sd	sh	inside back	arm height	from floor	weight lbs.	cubic feet
G5 plastic	26	26	33/40.5	17.75	18	18.5/26	16	7	28/35.5	37.6	12.75
G5 uph.	26	26	33/40.5	17.75	18	19/26.5	16	7	28/35.5	37.6	12.75
G6 plastic	26	26	36.5/46.5	17.75	18	22/31.75	16	7	28/35.5	38.6	12.75
G6 uph.	26	26	36.5/46.5	17.75	18	22.5/32.25	16	7	28/35.5	38.6	12.75

- Nine plastic colors

model	yds com (54")	sq ft col	com 1	col 2	3	4	5	6	7	8	9	10	11	12	13	14	15	L1	L2	L3
Upholstered Seat with Plastic Back																				
439	1	17.5	620	636	655	679	712	759	806	853	900	947	994	1,041	1,088	1,135	1,182	843	890	937

list

Plastic Seat and Back \$ 529

MESH BACK MID / COUNTER HEIGHT



	w	outside d	h	sw	seat sd	sh	inside back	arm height	from floor	weight lbs.	cubic feet
G5 plastic	26	26	32/39.5	17.75	18	18.5/26	15	7	28/35.5	36.6	12.75
G5 uph.	26	26	32/39.5	17.75	18	19/26.5	15	7	28/35.5	36.6	12.75
G6 plastic	26	26	35.5/45.5	17.75	18	22/31.75	15	7	28/35.5	37.6	12.75
G6 uph.	26	26	35.5/45.5	17.75	18	22.5/32.25	15	7	28/35.5	37.6	12.75

- Three mesh back colors

model	yds com (54")	sq ft col	com 1	col 2	3	4	5	6	7	8	9	10	11	12	13	14	15	L1	L2	L3
Upholstered Seat with Mesh Back																				
439M	1	17.5	673	689	708	732	765	812	859	906	953	1,000	1,047	1,094	1,141	1,188	1,235	896	943	990

list

Plastic Seat \$ 582

OPTIONS

Cylinder	Base	Casters/Glides	Plastic	Mesh Back (439M Only)	Seat Material	Fabric/Grade
G5 Mid Height (8") G6 Counter Height (10")	B11 Black Nylon - Standard B12 Polished Aluminum \$100	W24 Hard Wheel Casters - Standard W25 Soft Wheel Casters \$30 W6 2 1/4" High Glides \$30	BAT Battleship BLK Black BRD Bordeaux CHN Chestnut DPB Deep Blue SAG Sage SND Sand SLT Slate WHT White	MBK Black MDG Dark Gray MSL Silver	Plastic Upholstered	Grade, Vendor, Pattern, Color NOTE: For multiple fabric applications see page 14 for information and pricing

HOW TO ORDER

SPECIFY: Cylinder | base | casters/glides | plastic | mesh back | seat material | textile pattern and color.
See pages 5-14 for information and options on moisture barrier, CAL133, upholstery applications.

MODEL NUMBER

439

Arms	Base	Casters/Glides	Plastic	Mesh Back (439M Only)	Seat Material	Fabric/Grade
X9	B11	W24	X9	MBK	Upholstered	Grade 3, Momentum, Hue, Smoke

STOOL STANDARD FEATURES

- Chrome Frame
 - Fixed Arms
 - Basic Task Control
 - 20" Foot Ring
 - Black Nylon Base
 - Casters
 - All Styles Rated up to 300 lbs.
- NOTE: Add \$80 List for each fully assembled chair in carton.

UPHOLSTERED BACK AND SEAT MID / COUNTER HEIGHT



	w	outside d	h	sw	seat sd	sh	inside back	arm height	from floor	weight lbs.	cubic feet
G5 uph.	26	26	33/40.5	17.75	18	19/26.5	16	7	28/35.5	41.8	12.75
G6 uph.	26	26	36.5/46.5	17.75	18	22.5/32.25	16	7	31/41	42.8	12.75

• Black plastic is standard on upholstered seats and backs unless otherwise specified.

model	yds com (54")	sq ft col	com 1	col 2	3	4	5	6	7	8	9	10	11	12	13	14	15	L1	L2	L3
439UB	1	29	671	687	706	730	763	810	857	904	951	998	1,045	1,092	1,139	1,186	1,233	894	941	988

OPTIONS

Cylinder	Base	Casters/Glides	Plastic	Fabric/Grade
G5 Mid Height (8") G6 Counter Height (10")	B11 Black Nylon - Standard B12 Polished Aluminum \$100	W24 Hard Wheel Casters - Standard W25 Soft Wheel Casters \$30 W6 2 1/4" High Glides \$30	BAT Battleship BLK Black BRD Bordeaux CHN Chestnut DPB Deep Blue SAG Sage SND Sand SLT Slate WHT White	Grade, Vendor, Pattern, Color NOTE: For multiple fabric applications see page 14 for information and pricing

HOW TO ORDER

SPECIFY: Cylinder | base | casters/glides | plastic | textile pattern and color.
See pages 5-14 for information and options on moisture barrier, CAL133, upholstery applications

MODEL NUMBER

C439UB

Cylinder	Base	Casters/Glides	Plastic	Fabric/Grade
G5	B11	W24	BAT	Grade 3, Momentum, Hue, Smoke

STOOLS STANDARD FEATURES

- Armless
- Molded Seat Foam
- High Glides
- All Styles Rated up to 300 lbs.

PLASTIC BACK BAR HEIGHT

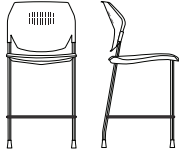

	w	outside d	h	sw	seat sd	sh	inside back	arm height	from floor	weight lbs.	cubic feet
plastic	20.5	23.5	45	15.5	19	30	15	n/a	n/a	37.2	17
								fixed arms (A5)	8	38.75	
uph.	20.5	23.5	45	16	19	30.25	15	n/a	n/a	37.2	17
								fixed arms (A5)	8	38.75	

- Six plastic colors

model	yds com (54")	sq ft col	com 1	col 2	3	4	5	6	7	8	9	10	11	12	13	14	15	L1	L2	L3
Upholstered Seat with Plastic Back																				
711	1	17.5	612	628	647	671	704	751	798	845	892	939	986	1,033	1,080	1,127	1,174	835	882	929

list

Plastic Seat and Back \$ 535

MESH BACK BAR HEIGHT

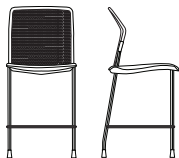

	w	outside d	h	sw	seat sd	sh	inside back	arm height	from floor	weight lbs.	cubic feet
	20.5	23.5	45.25	16	19	30.25	16	n/a	n/a	30.9	17
								fixed arms (A5)	8	38.75	

- Three mesh back colors

model	yds com (54")	sq ft col	com 1	col 2	3	4	5	6	7	8	9	10	11	12	13	14	15	L1	L2	L3
711M	1	17.5	609	625	644	668	701	748	795	842	889	936	983	1,030	1,077	1,124	1,171	832	879	926

OPTIONS

Frame	Arms	Plastic	Mesh Back (711M Only)	Seat Material	Seat Foam	Fabric/Grade
BF Black SF Silver	X9 No Arms - Standard  A5 Fixed Arms \$50 NOTE: Arm available in black only.	BAT Battleship BLK Black CHN Chestnut SAG Sage SLT Slate WHT White	MBK Black MDG Dark Gray MSL Silver	Plastic Upholstered	X9 None - Standard AF1 1/2" Additional Seat Foam \$35 NOTE: Add additional 10% for COM. Available on Upholstered Seat only.	X9 None Grade, Vendor, Pattern, Color NOTE: A sample of all COM fabrics must be submitted to OFS for preliminary approval prior to shipment of fabric. See ofs.com for COM Ordering Instructions.

HOW TO ORDER

SPECIFY: Frame | arms | plastic | mesh back | seat material | seat foam | textile pattern and color. See pages 5-14 for information and options on moisture barrier, CAL133, upholstery applications.

MODEL NUMBER

711

Frame	Arms	Plastic	Mesh Back (711M Only)	Seat Material	Seat Foam	Fabric/Grade
BF	X9	BAT	MBK	Upholstered	X9	Grade 3, Momentum, Hue, Smoke

STOOL STANDARD FEATURES

- Black or Silver Wall Saver Frame
- Six Plastic Colors
- Standard High Glides
- Fixed Arm or Armless
- Molded Seat Foam
- All Styles Rated up to 300 lbs.

UPHOLSTERED BACK AND SEAT BAR HEIGHT

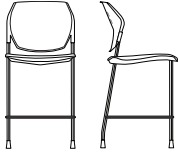

w	outside d	h	sw	seat sd	sh	inside back	arm height	from floor	weight lbs.	cubic feet
20.5	23.5	45	16	19	30.25	15	n/a	n/a	39.2	17
fixed arms (A5)							8	38.75	40.8	

- Six plastic colors
- Black plastic is standard on upholstered seats and backs unless otherwise specified.

model	yds com (54")	sq ft col	com 1	col 2	3	4	5	6	7	8	9	10	11	12	13	14	15	L1	L2	L3
711UB	1	29	710	726	745	769	802	849	896	943	990	1,037	1,084	1,131	1,178	1,225	1,272	933	980	1,027

OPTIONS

Frame	Arms	Seat Foam	Plastic	Fabric/Grade
BF Black Frame SF Silver Frame	X9 No Arms - Standard  A5 Fixed Arms \$50 NOTE: Arm available in black only.	X9 None - Standard AF1 1/2" Additional Seat Foam \$35 NOTE: Add additional 10% for COM.	BAT Battleship BLK Black CHN Chestnut SAG Sage SLT Slate WHT White NOTE: Black plastic is standard on all upholstered backs unless otherwise specified.	Grade, Vendor, Pattern, Color NOTE: For multiple fabric applications see page 14 for information and pricing

HOW TO ORDER

SPECIFY: Frame | arms | seat foam | plastic | textile pattern and color.
See pages 5-14 for information and options on moisture barrier, CAL133, upholstery applications.

MODEL NUMBER

C711UB

Frame	Arms	Seat Foam	Plastic	Fabric/Grade
BF	X9	X9	BLK	Grade 3, Momentum, Hue, Smoke

STOOLS STANDARD FEATURES

- Armless
 - Molded Seat Foam
 - Basic Task Control
 - 20" Foot Ring
 - Black Nylon Base
 - Casters
 - All Styles Rated up to 300 lbs.
- NOTE: Add \$80 List for each fully assembled chair in carton.**

PLASTIC BACK MID / COUNTER HEIGHT

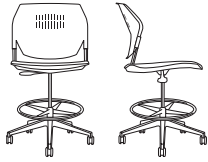

	w	outside d	h	sw	seat sd	sh	inside back	arm height	from floor	weight lbs.	cubic feet
G5 plastic	26	26	35/43	15.5	19	20/28	15	n/a	n/a	43.5	12.75
fixed arms (A5)								8	29.75/37.25		
G5 uph.	26	26	35/43	16	19	20.25/28.25	15	n/a	n/a	43.5	12.75
fixed arms (A5)								8	29.75/37.25		
G6 plastic	26	26	39/49	15.5	19	24/34	15	n/a	n/a	44.5	12.75
fixed arms (A5)								8	33.75/43.75		
G6 uph.	26	26	39/49	16	19	24.25/34.25	15	n/a	n/a	44.5	12.75
fixed arms (A5)								8	33.75/43.75		

• Six plastic colors

model	yds com (54")	sq ft col	com 1	col 2	3	4	5	6	7	8	9	10	11	12	13	14	15	L1	L2	L3
Upholstered Seat with Plastic Back																				
715	1	17.5	681	697	716	740	773	820	867	914	961	1,008	1,055	1,102	1,149	1,196	1,243	904	951	998

list

Plastic Seat and Back	\$ 604
------------------------------	--------

MESH BACK MID / COUNTER HEIGHT



cylinder	w	outside d	h	sw	seat sd	sh	inside back	arm height	from floor	weight lbs.	cubic feet
G5	26.5	26.5	35.5/43.5	16	19	20.5/28.5	16	n/a	n/a	39	12.75
fixed arms (A5)								8	29.75/37.25		
G6	26.5	26.5	38.5/48.5	16	19	24.5/34.5	16	n/a	n/a	40	12.75
fixed arms (A5)								8	33.75/43.75		

• Three mesh back colors

model	yds com (54")	sq ft col	com 1	col 2	3	4	5	6	7	8	9	10	11	12	13	14	15	L1	L2	L3
715M	1	17.3	686	702	721	745	778	825	872	919	966	1,013	1,060	1,107	1,154	1,201	1,248	909	956	1,003

OPTIONS

Frame	Arms	Base	Cylinder	Casters/Glides	Plastic	Mesh Back (715M Only)	Seat Material	Seat Foam	Fabric/Grade
BF Black SF Silver	X9 Armless - Standard  A5 Fixed Arms \$50 NOTE: Arm available in black only.	B11 Black Nylon - Standard B12 Polished Aluminum \$100	G5 Counter Height (8") G6 Bar Height (10")	W24 Hard Wheel Casters - Standard W25 Soft Wheel Casters \$30 W6 2 1/4" High Glides \$30	BAT Battleship BLK Black CHN Chestnut SAG Sage SLT Slate WHT White	MBK Black MDG Dark Gray MSL Silver	Plastic Upholstered	X9 None AF1 1/2" Additional Seat Foam \$35 NOTE: Add additional 10% for COM. Available on Upholstered Seat only.	X9 None Grade, Vendor, Pattern, Color NOTE: For multiple fabric applications see page 14 for information and pricing

HOW TO ORDER

SPECIFY: Frame | arms | base | cylinder | casters/glides | plastic | mesh back | seat material | seat foam | textile pattern and color.
See pages 5-14 for information and options on moisture barrier, CAL133, upholstery applications.

MODEL NUMBER

715

Frame	Arms	Base	Cylinder	Casters/Glides	Plastic	Mesh Back	Seat Material	Seat Foam	Fabric/Grade
BF	X9	B11	G5	W24	BAT		Upholstered	X9	Grade 3 Momentum, Hue, Smoke

STOOL STANDARD FEATURES

- Armless
 - Molded Seat Foam
 - Basic Task Control
 - 20" Foot Ring
 - Black Nylon Base
 - Casters
 - All Styles Rated up to 300 lbs.
- NOTE: Add \$80 List for each fully assembled chair in carton.

UPHOLSTERED BACK AND SEAT MID / COUNTER HEIGHT

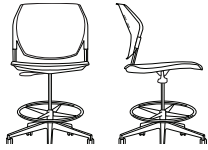

cylinder	w	outside		sw	seat		inside back	arm height	from floor	weight lbs.	cubic feet
		d	h		sd	sh					
G5	26	26	35.25/43.25	16	18.5	20.25/28.25	15	n/a	n/a	44.5	12.75
fixed arms (A5)								8	29.75/37.25		
G6	26	26	39.25/49.25	16	18.5	24.25/34.25	15	n/a	n/a	45.5	12.75
fixed arms (A5)								8	33.75/43.75		

- Six plastic colors
- Black plastic is standard on upholstered seats and backs unless otherwise specified.

model	yds com (54")	sq ft col	com 1	col 2	3	4	5	6	7	8	9	10	11	12	13	14	15	L1	L2	L3
715UB	1	29	777	793	812	836	869	916	963	1,010	1,057	1,104	1,151	1,198	1,245	1,292	1,339	1,000	1,047	1,094

OPTIONS

Frame	Arms	Base	Cylinder	Casters/Glides	Plastic	Seat Foam	Fabric/Grade
BF Black SF Silver	X9 Armless - Standard  A5 Fixed Arms \$50 NOTE: Arm available in black only.	B11 Black Nylon - Standard B12 Polished Aluminum \$100	G5 Counter Height (8") G6 Bar Height (10")	W24 Hard Wheel Casters - Standard W25 Soft Wheel Casters \$30 W6 2 1/4" High Glides \$30	BAT Battleship BLK Black CHN Chestnut SAG Sage SLT Slate WHT White	X9 None - Standard AF1 1/2" Additional Seat Foam \$35 NOTE: Add additional 10% for COM.	Grade , Vendor, Pattern, Color NOTE: For multiple fabric applications see page 14 for information and pricing

HOW TO ORDER

SPECIFY: Frame | arms | base | cylinder | casters/glides | plastic | seat foam | textile pattern and color.
See pages 5-14 for information and options on moisture barrier, CAL133, upholstery applications.

MODEL NUMBER

715UB

Frame	Arms	Base	Cylinder	Casters/Glides	Plastic	Seat Foam	Fabric/Grade
BF	X9	B11	G5	W24	BAT	X9	Grade 3, Momentum, Hue, Smoke

MID BACK CHAIR STANDARD FEATURES

- Chrome Frame
- Armless
- Plastic or Upholstered Seat

- Black Nylon Base
- Casters
- All Styles Rated up to 300 lbs.

NOTE: Add \$80 List for each fully assembled chair in carton.

PLASTIC BACK



	w	outside d	h	sw	seat sd	sh	inside back	arm height	from floor	weight lbs.	cubic feet
plastic	26	26	30.25/35.5	17.75	18	14.5/19.75	16	n/a	n/a	23.50	12.75
uph.	26	26	30.25/35.5	17.75	18	15/20.25	16	n/a	n/a	23.50	12.75

- Nine plastic colors

model	yds com (54")	sq ft col	com 1	col 2	3	4	5	6	7	8	9	10	11	12	13	14	15	L1	L2	L3
Upholstered Seat with Plastic Back																				
422	1	17.5	412	428	447	471	504	551	598	645	692	739	786	833	880	927	974	635	682	729

list

Plastic Seat and Back \$ 321

MESH BACK



	w	outside d	h	sw	seat sd	sh	inside back	arm height	from floor	weight lbs.	cubic feet
plastic	26	26	29.25/34.5	17.75	18	14.5/19.75	15	n/a	n/a	23.50	12.75
uph.	26	26	29.25/34.5	17.75	18	15/20.25	15	n/a	n/a	23.50	12.75

- Three mesh back colors

model	yds com (54")	sq ft col	com 1	col 2	3	4	5	6	7	8	9	10	11	12	13	14	15	L1	L2	L3
Upholstered Seat with Mesh Back																				
422M	1	17.5	468	484	503	527	560	607	654	701	748	795	842	889	936	983	1,030	691	738	785

list

Plastic Seat \$ 378

OPTIONS

Control	Base	Casters/Glides	Plastic	Mesh Back (422M Only)	Seat Material	Fabric/Grade
T4 Basic Task - Standard S1 Swivel Tilt \$38	B11 Black Nylon - Standard B12 Polished Aluminum \$100	W24 Hard Wheel Casters - Standard W25 Soft Wheel Casters \$30 W6 2 1/4" High Glides \$30	BAT Battleship BLK Black BRD Bordeaux CHN Chestnut DPB Deep Blue SAG Sage SND Sand SLT Slate WHT White	MBK Black MDG Dark Gray MSL Silver	Plastic Upholstered	Grade, Vendor, Pattern, Color NOTE: For multiple fabric applications see page 14 for information and pricing

HOW TO ORDER

SPECIFY: Control | base | casters/glides | plastic | mesh back | seat material | textile pattern and color.
See pages 5-14 for information and options on moisture barrier, CAL133 and upholstery applications.

MODEL NUMBER

422

Control	Base	Casters/Glides	Plastic	Mesh Back (422M Only)	Seat Material	Fabric/Grade
T4	B11	W24	BAT		Upholstered	Grade 3, Momentum, Hue, Smoke

MID BACK CHAIR STANDARD FEATURES

- Chrome Frame
- Black Nylon Base
- All Styles Rated up to 300 lbs.
- Armless
- Casters
- NOTE: Add \$80 List for each fully assembled chair in carton.

UPHOLSTERED BACK AND SEAT



w	outside d	h	sw	seat sd	sh	inside back	arm height	from floor	weight lbs.	cubic feet
26	26	30.25/35.5	17.75	18	15/20.25	16	n/a	n/a	27.70	12.75

• Black plastic is standard on upholstered seats and backs unless otherwise specified.

model	yds com (54")	sq ft col	com 1	col 2	3	4	5	6	7	8	9	10	11	12	13	14	15	L1	L2	L3
422UB	1	29	464	480	499	523	556	603	650	697	744	791	838	885	932	979	1,026	687	734	781

OPTIONS

Control	Base	Casters/Glides	Plastic	Fabric/Grade
T4 Basic Task - Standard S1 Swivel Tilt \$38	B11 Black Nylon - Standard B12 Polished Aluminum \$100	W24 Hard Wheel Casters - Standard W25 Soft Wheel Casters \$30 W6 2 1/4" High Glides \$30	BAT Battleship BLK Black BRD Bordeaux CHN Chestnut DPB Deep Blue SAG Sage SND Sand SLT Slate WHT White	Grade, Vendor, Pattern, Color NOTE: For multiple fabric applications see page 14 for information and pricing

HOW TO ORDER

SPECIFY: Control | base | casters/glides | plastic | textile pattern and color.
See pages 5-14 for information and options on moisture barrier, CAL133, upholstery applications.

MODEL NUMBER

422UB

Control	Base	Casters/Glides	Plastic	Fabric/Grade
T4	B11	W24	BAT	Grade 3, Momentum, Hue, Smoke

MID BACK CHAIR STANDARD FEATURES

- Chrome Frame
- Fixed Arms
- Plastic or Upholstered Seat
- Black Nylon Base
- Casters
- All Styles Rated up to 300 lbs.

NOTE: Add \$80 List for each fully assembled chair in carton.

PLASTIC BACK



	w	outside d	h	sw	seat sd	sh	inside back	arm height	from floor	weight lbs.	cubic feet
plastic	26	26	30.25/35.5	17.75	18	14.5/19.75	16	7	23.5/28.5	23.50	12.75
uph.	26	26	30.25/35.5	17.75	18	15/20.25	16	7	23.5/28.5	25	12.75

- Nine plastic colors

model	yds com (54")	sq ft col	com 1	col 2	3	4	5	6	7	8	9	10	11	12	13	14	15	L1	L2	L3
Upholstered Seat with Plastic Back																				
429	1	17.5	460	476	495	519	552	599	646	693	740	787	834	881	928	975	1,022	683	730	777

list

Plastic Seat and Back	\$ 369
-----------------------	--------

MESH BACK



	w	outside d	h	sw	seat sd	sh	inside back	arm height	from floor	weight lbs.	cubic feet
plastic	26	26	29.25/34.5	17.75	18	14.5/19.75	15	7	23.5/28.5	23.50	12.75
uph.	26	26	29.25/34.5	17.75	18	15/20.25	15	7	23.5/28.5	23.50	12.75

- Three mesh back colors

model	yds com (54")	sq ft col	com 1	col 2	3	4	5	6	7	8	9	10	11	12	13	14	15	L1	L2	L3
Upholstered Seat with Mesh Back																				
429M	1	17.5	516	532	551	575	608	655	702	749	796	843	890	937	984	1,031	1,078	739	786	833

control

list

Plastic Seat	T4	\$ 425
--------------	----	--------

OPTIONS

Control	Base	Castors/Glides	Plastic	Mesh Back (429M Only)	Seat Material	Fabric/Grade
T4 Basic Task - Standard S1 Swivel Tilt \$38	B11 Black Nylon - Standard B12 Polished Aluminum \$100	W24 Hard Wheel Casters - Standard W25 Soft Wheel Casters \$30 W6 2 1/4" High Glides \$30	BAT Battleship BLK Black BRD Bordeaux CHN Chestnut DPB Deep Blue SAG Sage SND Sand SLT Slate WHT White	MBK Black MDG Dark Gray MSL Silver	Plastic Upholstered	Grade, Vendor, Pattern, Color NOTE: For multiple fabric applications see page 14 for information and pricing

HOW TO ORDER

SPECIFY: Control | base | casters/glides | plastic | mesh back | textile pattern and color.
See pages 5-14 for information and options on moisture barrier, CAL133, upholstery applications.

MODEL NUMBER

429

Control	Base	Castors/Glides	Plastic	Mesh Back	Seat Material	Fabric/Grade
T4	B11	W24	BAT		Upholstered	Grade 3, Momentum, Hue, Smoke

MID BACK CHAIR STANDARD FEATURES

- Upholstered Back and Seat
- Chrome Frame
- Fixed Arm
- Black Nylon Base
- Casters
- All Styles Rated up to 300 lbs.

NOTE: Add \$80 List for each fully assembled chair in carton.

UPHOLSTERED BACK AND SEAT



w	outside d	h	sw	seat sd	sh	inside back	arm height	from floor	weight lbs.	cubic feet
26	26	30.25/35.5	17.75	18	15/20.25	16	7	23.5/28.5	27.70	12.75

- Black plastic is standard on upholstered seats and backs unless otherwise specified.

model	yds com (54")	sq ft col	com 1	col 2	3	4	5	6	7	8	9	10	11	12	13	14	15	L1	L2	L3
429UB	1	29	512	528	547	571	604	651	698	745	792	839	886	933	980	1,027	1,074	735	782	829

OPTIONS

Control	Base	Casters/Glides	Plastic	Fabric/Grade
T4 Basic Task - Standard S1 Swivel Tilt \$38	B11 Black Nylon - Standard B12 Polished Aluminum \$100	W24 Hard Wheel Casters - Standard W25 Soft Wheel Casters \$30 W6 2 1/4" High Glides \$30	BAT Battleship BLK Black BRD Bordeaux CHN Chestnut DPB Deep Blue SAG Sage SND Sand SLT Slate WHT White	Grade, Vendor, Pattern, Color NOTE: For multiple fabric applications see page 14 for information and pricing.

HOW TO ORDER

SPECIFY: Control | base | casters/glides | plastic | textile pattern and color.
See pages 5-14 for information and options on moisture barrier, CAL133, upholstery applications.

MODEL NUMBER

C429UB

Control	Base	Casters/Glides	Plastic	Fabric/Grade
T4	B11	W24	BAT	Grade 3, Momentum, Hue, Smoke

TASK CHAIR STANDARD FEATURES

- Armless
- Casters
- All Styles Rated up to 300 lbs.
- Molded Seat Foam
- Black Nylon Base
- NOTE: Add \$80 List for each fully assembled chair in carton.

PLASTIC BACK



	w	outside d	h	sw	seat sd	sh	inside back	arm height	from floor	weight lbs.	cubic feet
plastic	26	26	31/36	15.5	19	16/21	15	n/a	n/a	39.5	12.75
fixed arms (A5)									8	24.25/29.25	
uph.	26	26	31/36	16	19	16.25/21.25	15	n/a	n/a	39.5	12.75
fixed arms (A5)									8	24.25/29.25	

- Six plastic colors

model	yds com (54")	sq ft col	com 1	col 2	3	4	5	6	7	8	9	10	11	12	13	14	15	L1	L2	L3
Upholstered Seat with Plastic Back																				
705	1	17.5	514	530	549	573	606	653	700	747	794	841	888	935	982	1,029	1,076	737	784	831

list

Plastic Seat and Back \$ 437

MESH BACK



	w	outside d	h	sw	seat sd	sh	inside back	arm height	from floor	weight lbs.	cubic feet
	26.5	26.5	31.25/36.5	16	19	16.25/21.25	16	n/a	n/a	34	12.75
fixed arms (A5)									8	24.25/29.25	

- Three mesh back colors

model	yds com (54")	sq ft col	com 1	col 2	3	4	5	6	7	8	9	10	11	12	13	14	15	L1	L2	L3
705M	1	17.5	513	529	548	572	605	652	699	746	793	840	887	934	981	1,028	1,075	736	783	830

OPTIONS

Frame	Arms	Control	Base	Casters/Glides	Plastic	Mesh Back (705M Only)	Seat Material	Seat Foam	Fabric/Grade
BF Black SF Silver	X9 No Arms - Standard A5 Fixed Arms \$50 NOTE: Available in black only.	T4 Basic Task - Standard S1 Swivel Tilt \$51	B11 Black Nylon - Standard B12 Polished Aluminum \$100	W24 Hard Wheel Casters W25 Soft Wheel Casters \$30 W6 2 1/4" High Glides \$30	BAT Battleship BLK Black CHN Chestnut SAG Sage SLT Slate WHT White	MBK Black MDG Dark Gray MSL Silver	Plastic Upholstered	X9 None - Standard AF1 1/2" Additional Seat Foam \$35 NOTE: Add additional 10% for COM.	X9 None Grade, Vendor, Pattern, Color NOTE: For multiple fabric applications see page 14 for information and pricing.

HOW TO ORDER

SPECIFY: Frame | arms | control | base | casters/glides | plastic | mesh back | seat material | seat foam | textile pattern and color. See pages 5-14 for information and options on moisture barrier, CAL133, upholstery applications.

MODEL NUMBER

705M

Frame	Arms	Control	Base	Casters/Glides	Plastic	Mesh Back (705M Only)	Seat Material	Seat Foam	Fabric/Grade
BF	X9	T4	B11	W24	BAT	MBK	Upholstered	X9	Grade 3, Momentum, Hue, Smoke

TASK CHAIR STANDARD FEATURES

- Upholstered Back and Upholstered Seat
 - Black or Silver Frame
 - Fixed Arm or Armless
 - Molded Seat Foam
 - Black Nylon Base
 - Casters
 - All Styles Rated up to 300 lbs.
- NOTE: Add \$80 List for each fully assembled chair in carton.

UPHOLSTERED BACK AND SEAT



w	outside d	h	sw	seat sd	sh	inside back	arm height	from floor	weight lbs.	cubic feet
26	26	31.25/36.25	16	18.5	16.25/21.25	15	n/a	n/a	40.5	12.75
fixed arms (A5)							8	24.25/29.25		

- Six plastic colors
- Black plastic is standard on upholstered seats and backs unless otherwise specified.

model	yds com (54")	sq ft col	com 1	col 2	3	4	5	6	7	8	9	10	11	12	13	14	15	L1	L2	L3
705UB	1	29	607	623	642	666	699	746	793	840	887	934	981	1,028	1,075	1,122	1,169	830	877	924

OPTIONS

Frame	Arms	Control	Seat Foam	Base	Casters/Glides	Plastic	Fabric/Grade
BF Black Frame SF Silver Frame	X9 No Arms - Standard  A5 Fixed Arms \$50 NOTE: Arm available in black only.	T4 Basic Task - Standard S1 Swivel Tilt \$49	X9 None - Standard AF1 1/2" Additional Seat Foam \$35 NOTE: Add additional 10% for COM.	B11 Black Nylon - Standard B12 Polished Aluminum \$100	W24 Hard Wheel Casters - Standard W25 Soft Wheel Casters \$30 W6 2 1/4" High Glides \$30	BAT Battleship BLK Black CHN Chestnut SAG Sage SLT Slate WHT White NOTE: Black plastic is standard on all upholstered backs unless otherwise specified.	Grade, Vendor, Pattern, Color NOTE: For multiple fabric applications see page 14 for information and pricing.

HOW TO ORDER

SPECIFY: Frame | arms | control | seat foam | base | casters/glides | plastic | mesh back | textile pattern and color.
See pages 5-14 for information and options on moisture barrier, CAL133, upholstery applications.

MODEL NUMBER

705UB

Frame	Arms	Control	Seat Foam	Base	Casters/Glides	Plastic	Fabric/Grade
BF	X9	T4	X9	B11	W24	BLK	Grade 3, Momentum, Hue, Smoke

HUG PATIENT STANDARD FEATURES

- Upholstered Seat and Back
- European Beech Frame
- Clean-Thru Design
- Wall-Saver Design
- Detailed Seams
- Non-Marring Adjustable Glides

PATIENT CHAIR

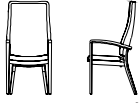

w	outside			sw	seat			seat to top of back	arm height	weight lbs.	cubic feet
	d	h			sd	sh					
24	26	46		20	19	19		27	27	27	24

model	yds com (54")	sq ft col	com 1	col 2	3	4	5	6	7	8	9	10	11	12	13	14	15	L1	L2	L3
1225	2.5	n/a	1,146	1,187	1,234	1,293	1,375	1,493	1,610	1,728	1,845	1,963	2,081	2,198	2,316	2,433	2,551	1,661	1,780	1,896

OPTIONS

Finish	Arm Cap	Fabric 1	Fabric 2
Selection Required	Standard X9 No Arm Cap	Selection Required	Selection Required
See page 9 for full list of finish options	Resin \$52 pair D1N Black D1M Taupe D1P Grey Solid Surface \$485 pair CWS Cameo White MWS Modern White CSS Concrete DMS Deep Mink	Fabric: Grade, Vendor, Pattern, Color	Fabric: Grade, Vendor, Pattern, Color NOTE: For multiple fabric application see page 14 for information and pricing.

HOW TO ORDER

SPECIFY: Finish | Arm Cap | Textile pattern and color. See **pages 5-14** for information and options on moisture barrier, CAL133, upholstery applications, a complete offering of finishes and ordering details

MODEL NUMBER

1225

Finish	Arm Cap	Fabric 1	Fabric 2
MNW	X9	Grade 5, Momentum, Row, Breeze	Grade 5, Momentum, Row, Breeze

INTERLUDE UPHOLSTERED BACK PATIENT CHAIR STANDARD FEATURES

- Clean-Thru Design
- Upholstered Seat and Back
- Upholstered Arm with European Beech Arm Cap on 1926
- European Beech Open Arm Frame with Arm Cap on 1926OA
- Wallsaver Design
- Legs made of 1 x 2 16 Gauge Tubing (.06" Wall Thickness)
- Field Replaceable Components
- Non-Marring Adjustable Glides

UPHOLSTERED BACK W/ UPHOLSTERED ARM PANELS, PATIENT CHAIR



w	outside d	h	sw	seat sd	sh	seat to top of back	arm height	weight lbs.	cubic feet
25	24.5	44	20.5	18	19	25	25.5	41	24

model	yds com (54")	sq ft col	com 1	col 2	3	4	5	6	7	8	9	10	11	12	13	14	15	L1	L2	L3
1926	2.5	n/a	1,654	1,695	1,742	1,801	1,883	2,001	2,118	2,236	2,353	2,471	2,589	2,706	2,824	2,941	3,059	2,169	2,288	2,404

UPHOLSTERED BACK W/ OPEN ARMS, PATIENT CHAIR

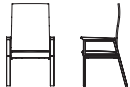

w	outside d	h	sw	seat sd	sh	seat to top of back	arm height	weight lbs.	cubic feet
23	24.5	44	20.5	18	19	25	25.5	41	24

model	yds com (54")	sq ft col	com 1	col 2	3	4	5	6	7	8	9	10	11	12	13	14	15	L1	L2	L3
1926OA	1.75	n/a	1,676	1,705	1,738	1,779	1,836	1,919	2,001	2,083	2,166	2,248	2,330	2,413	2,495	2,577	2,659	2,045	2,128	2,210

OPTIONS

Arm Caps	Finish	Powder Coat	Removable Covers	Fabric 1
Standard X3 Wood	Standard X9 No Selection of Option	Selection Required	Standard X9 No Selection of Option	Selection Required
A4 Poly (black) \$231 pair	See page 9 for full list of finish options NOTE: Select finish when 1926OA model or A3 wood arm cap option is specified	BWT Bone White BUFF Buff CHLK Chalk SGLD Gold GRPH Graphite MSL Luster Grey HIP Oiled Bronze BKO Onyx POLR Polar SBRZ Soft Bronze HIF Warm Grey	B1L Removable Seat Cover only \$98	Fabric: Grade, Vendor, Pattern, Color NOTE: For multiple fabric applications see page 14 for information and pricing

HOW TO ORDER

SPECIFY: Arm caps | wood finish (if applicable) | powder coat | removable covers | textile pattern and color. See pages 5-14 for information and options on moisture barrier, CAL133, upholstery applications, a complete offering of finishes and ordering details.

MODEL NUMBER

1926

Arm Caps	Finish	Powder Coat	Removable Covers	Fabric 1
A4	MLC	BWT	B1L	Grade 5, Momentum, Row, Breeze

EASY ACCESS STOOL STANDARD FEATURES

- Fully Upholstered Seat and Back
- Fixed Arms
- Floor Saver Swivel Glides
- Clean-Thru Design
- Rated up to 350 lbs.

EASY ACCESS

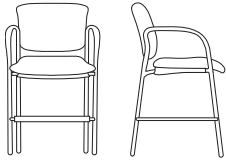



w	outside d	h	sw	seat sd	sh	inside back	arm height	from floor	weight lbs.	cubic feet
24	25	39	16.5	18.25	24	14.5	8.5	32.5	44	18

- With arms only

model	yds com (54")	sq ft col	com 1	col 2	3	4	5	6	7	8	9	10	11	12	13	14	15	L1	L2	L3
C2419	1.5	30	727	752	780	815	865	935	1,006	1,076	1,147	1,217	1,288	1,358	1,429	1,499	1,570	1,047	1,119	1,188

OPTIONS

Frame	Arms	Glides	Fabric 1	Fabric 2
BF Black SF Silver	 BA Fixed Black Arms - Standard  SA Fixed Silver Arms \$32	W37 Floor-Saver Swivel Glides - Standard W38 Felt Tip Swivel Glides \$22	Grade, Vendor, Pattern, Color	Grade, Vendor, Pattern, Color

HOW TO ORDER

SPECIFY: Frame | arms | glides | fabric 1 | fabric 2
 See pages 5-14 for information and options on moisture barrier, CAL133, upholstery applications.

MODEL NUMBER

C2419

Frame	Arms	Glides	Fabric 1	Fabric 2
BF	BA	W37	Grade 3, Momentum, Hue, Smoke	Grade 3, Momentum, Epic, Limestone

MODERN AMENITY OPEN ARM PATIENT CHAIR STANDARD FEATURES

- 1625-MOTION Mechanism Designed Specifically with up to 8" of Smooth Travel
- Upholstered Seat and Back
- Spring Seat Construction
- Clean-Thru Design
- Wall-Saver Design
- Must specify European Beech or American Ash Frame
- Wood Arm Cap
- Non-Marring Adjustable Glides
- Field Replaceable Components
- NOTE: Because of the unique Color of Ash Hardwoods, Stains are a slightly different Color than they appear on the Standard European Beech Hardwoods. If pairing with a Product using Species other than Ash the Stains will appear different. For additional information please contact your Customer Service Representative.

PATIENT CHAIR, OPEN ARM



w	outside d	h	sw	seat sd	sh	seat to top of back	arm height	weight lbs.	cubic feet
24	26	45	20.75	22.25	19	24	26.75	41	24

model	yds com (54")	sq ft col	com 1	col 2	3	4	5	6	7	8	9	10	11	12	13	14	15	L1	L2	L3
1625	2	n/a	1,441	1,474	1,512	1,559	1,624	1,718	1,812	1,907	2,001	2,095	2,189	2,283	2,377	2,471	2,565	1,859	1,954	2,047

MOTION PATIENT CHAIR OPEN ARM



w	outside d	h	sw	seat sd	sh	seat to top of back	arm height	weight lbs.	cubic feet
24	26	45	20.75	22.25	19	24	26.75	50	24

model	yds com (54")	sq ft col	com 1	col 2	3	4	5	6	7	8	9	10	11	12	13	14	15	L1	L2	L3
1625-MOTION	2	n/a	1,891	1,924	1,962	2,009	2,074	2,168	2,262	2,357	2,451	2,545	2,639	2,733	2,827	2,921	3,015	2,309	2,404	2,497

OPTIONS

Wood Species	Arm Caps	Finish	Removable Covers	Fabric 1
Selection Required	Standard A3 Wood	Selection Required	Standard X9 No Selection of Option	Selection Required
A8S European Beech A8T American Ash	Poly \$109 pair DIN Black DIM Taupe DIP Grey Solid Surface \$624 pair CWS Cameo White MWS Modern White CSS Concrete DMS Deep Mink	See page 9 for full list of finish options	H7 Removable Seat and Back Covers \$196 B1L Removable Seat Cover only \$98 B1M Removable Back Cover only \$98	Fabric: Grade, Vendor, Pattern, Color \$196 NOTE: For multiple fabric applications see page 14 for information and pricing

HOW TO ORDER

SPECIFY: Wood species | arm caps | wood finish | removable covers | textile pattern and color. See pages 5-14 for information and options on moisture barrier, CAL133, upholstery applications, a complete offering of finishes and ordering details.

MODEL NUMBER

1625

Wood Species	Arm Caps	Finish	Removable Covers	Fabric 1
A8S	DIN	MLC	H7	Grade 5, Momentum, Row, Breeze

MODERN AMENITY PANEL ARM PATIENT CHAIR STANDARD FEATURES

- 1635-MOTION Mechanism Designed Specifically with up to 8" of Smooth Travel
- Upholstered Arms, Seat and Back
- Spring Seat Construction
- Clean-Thru Design
- Wall-Saver Design
- Must specify European Beech or American Ash Frame
- Wood Arm Cap
- Non-Marring Adjustable Glides
- Field Replaceable Components
- NOTE: Because of the unique Color of Ash Hardwoods, Stains are a slightly different Color than they appear on the Standard European Beech Hardwoods. If pairing with a Product using Species other than Ash the Stains will appear different. For additional information please contact your Customer Service Representative.

PATIENT CHAIR, PANEL ARM



w	outside d	h	sw	seat sd	sh	seat to top of back	arm height	weight lbs.	cubic feet
24	26	45	20.75	22.25	19	24	26.75	41	24

model	yds com (54")	sq ft col	com 1	col 2	3	4	5	6	7	8	9	10	11	12	13	14	15	L1	L2	L3
1635	2.75	n/a	1,571	1,616	1,668	1,733	1,823	1,952	2,082	2,211	2,340	2,470	2,599	2,728	2,858	2,987	3,116	2,135	2,266	2,394

MOTION PATIENT CHAIR, PANEL ARM

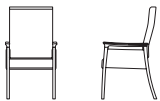

w	outside d	h	sw	seat sd	sh	seat to top of back	arm height	weight lbs.	cubic feet
24	26	45	20.75	22.25	19	24	26.75	41	24

model	yds com (54")	sq ft col	com 1	col 2	3	4	5	6	7	8	9	10	11	12	13	14	15	L1	L2	L3
1635-MOTION	2.75	n/a	1,967	2,012	2,064	2,129	2,219	2,348	2,478	2,607	2,736	2,866	2,995	3,124	3,254	3,383	3,512	2,531	2,662	2,790

OPTIONS

Wood Species	Arm Caps	Finish	Removable Covers	Fabric 1
Selection Required	Standard A3 Wood	Selection Required	Standard X9 No Selection of Option	Selection Required
A8S European Beech A8T American Ash	Poly \$109 pair DIN Black DIM Taupe DIP Grey Solid Surface \$624 pair CWS Cameo White MWS Modern White CSS Concrete DMS Deep Mink	See page 9 for full list of finish options	H7 Removable Seat and Back Covers \$196 B1L Removable Seat Cover only \$98 B1M Removable Back Cover only \$98	Fabric: Grade, Vendor, Pattern, Color NOTE: For multiple fabric applications see page 14 for information and pricing

HOW TO ORDER

SPECIFY: Wood species | arm caps | wood finish | removable covers | textile pattern and color. See pages 5-14 for information and options on moisture barrier, CAL133, upholstery applications, a complete offering of finishes and ordering details.

MODEL NUMBER

1635

Wood Species	Arm Caps	Finish	Removable Covers	Fabric 1
A8S	DIN	MLC	H7	Grade 5, Momentum, Row, Breeze

MODERN AMENITY OPEN ARM EASY ACCESS CHAIR STANDARD FEATURES

- 1625-MOTION Mechanism Designed Specifically with up to 8" of Smooth Travel
- Upholstered Seat and Back
- Spring Seat Construction
- Clean-Thru Design
- Wall-Saver Design
- Must specify European Beech or American Ash Frame
- Wood Arm Cap
- Non-Marring Adjustable Glides
- Field Replaceable Components
- NOTE: Because of the unique Color of Ash Hardwoods, Stains are a slightly different Color than they appear on the Standard European Beech Hardwoods. If pairing with a Product using Species other than Ash the Stains will appear different. For additional information please contact your Customer Service Representative.

OPEN ARM EASY ACCESS CHAIR



w	outside			sw	seat			seat to top of back	arm height	weight lbs.	cubic feet
	d	h			sd	sh					
24	28.5	34		20.25	19	23.5	15	39	45	24	

model	yds com (54")	sq ft col	com 1	col 2	3	4	5	6	7	8	9	10	11	12	13	14	15	L1	L2	L3
1675	1.5	n/a	1,529	1,554	1,582	1,617	1,667	1,737	1,808	1,878	1,949	2,019	2,090	2,160	2,231	2,301	2,372	1,849	1,921	1,990

OPEN ARM MOTION EASY ACCESS CHAIR

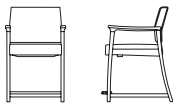

w	outside			sw	seat			seat to top of back	arm height	weight lbs.	cubic feet
	d	h			sd	sh					
24	28.5	34		20.25	19	23.5	15	39	55	24	

model	yds com (54")	sq ft col	com 1	col 2	3	4	5	6	7	8	9	10	11	12	13	14	15	L1	L2	L3
1675-MOTION	1.5	n/a	1,975	2,000	2,028	2,063	2,113	2,183	2,254	2,324	2,395	2,465	2,536	2,606	2,677	2,747	2,818	2,295	2,367	2,436

OPTIONS

Wood Species	Arm Caps	Finish	Removable Covers	Fabric 1
Selection Required	Standard A3 Wood	Selection Required	Standard X9 No Selection of Option	Selection Required
A8S European Beech A8T American Ash	Poly \$109 pair DIN Black DIM Taupe DIP Grey Solid Surface \$624 pair CWS Cameo White MWS Modern White CSS Concrete DMS Deep Mink	See page 9 for full list of finish options	H7 Removable Seat and Back Covers \$196 B1L Removable Seat Cover only \$98 B1M Removable Back Cover only \$98	Fabric: Grade, Vendor, Pattern, Color NOTE: For multiple fabric applications see page 14 for information and pricing

HOW TO ORDER

SPECIFY: Wood species | arm caps | wood finish | removable covers | textile pattern and color. See pages 5-14 for information and options on moisture barrier, CAL133, upholstery applications, a complete offering of finishes and ordering details.

MODEL NUMBER

1675

Wood Species	Arm Caps	Finish	Removable Covers	Fabric 1
A8S	D1N	MLC	H7	Grade 5, Momentum, Row, Breeze

MODERN AMENITY PANEL ARM EASY ACCESS CHAIR STANDARD FEATURES

- 1635-MOTION Mechanism Designed Specifically with up to 8" of Smooth Travel
- Upholstered Arms, Seat and Back
- Spring Seat Construction
- Clean-Thru Design
- Wall-Saver Design
- Must specify European Beech or American Ash Frame
- Wood Arm Cap
- Non-Marring Adjustable Glides
- Field Replaceable Components
- NOTE: Because of the unique Color of Ash Hardwoods, Stains are a slightly different Color than they appear on the Standard European Beech Hardwoods. If pairing with a Product using Species other than Ash the Stains will appear different. For additional information please contact your Customer Service Representative.

PANEL ARM EASY ACCESS CHAIR

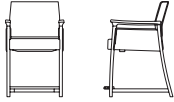

w	outside			sw	seat			seat to top of back	arm height	weight lbs.	cubic feet
	d	h			sd	sh					
24	28.5	34		20.25	19	23.5	15	39	45	24	

model	yds com (54")	sq ft col	com 1	col 2	3	4	5	6	7	8	9	10	11	12	13	14	15	L1	L2	L3
1685	2.25	n/a	1,650	1,687	1,729	1,782	1,856	1,962	2,068	2,174	2,280	2,385	2,491	2,597	2,703	2,809	2,914	2,117	2,223	2,328

PANEL ARM MOTION EASY ACCESS CHAIR

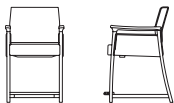

w	outside			sw	seat			seat to top of back	arm height	weight lbs.	cubic feet
	d	h			sd	sh					
24	28.5	34		20.25	19	23.5	15	39	55	24	

model	yds com (54")	sq ft col	com 1	col 2	3	4	5	6	7	8	9	10	11	12	13	14	15	L1	L2	L3
1685-MOTION	2.25	n/a	2,096	2,133	2,175	2,228	2,302	2,408	2,514	2,620	2,726	2,831	2,937	3,043	3,149	3,255	3,360	2,563	2,669	2,774

OPTIONS

Wood Species	Arm Caps	Finish	Removable Covers	Fabric 1
Selection Required	Standard A3 Wood	Selection Required	Standard X9 No Selection of Option	Selection Required
A8S European Beech A8T American Ash	Poly \$109 pair DIN Black DIM Taupe DIP Grey Solid Surface \$624 pair CWS Cameo White MWS Modern White CSS Concrete DMS Deep Mink	See page 9 for full list of finish options	H7 Removable Seat and Back Covers \$196 B1L Removable Seat Cover only \$98 B1M Removable Back Cover only \$98	Fabric: Grade, Vendor, Pattern, Color NOTE: For multiple fabric applications see page 14 for information and pricing

HOW TO ORDER

SPECIFY: Wood species | arm caps | wood finish | removable covers | textile pattern and color. See pages 5-14 for information and options on moisture barrier, CAL133, upholstery applications, a complete offering of finishes and ordering details.

MODEL NUMBER

1685

Wood Species	Arm Caps	Finish	Removable Covers	Fabric 1
A8S	DIN	MLC	H7	Grade 5, Momentum, Row, Breeze

MODERN AMENITY GLIDER STANDARD FEATURES

- Glider Mechanism allows for 2-3 Inches of Glide Motion Front and Back
- Locking Knob for Transportation Located on Mechanism under Glider
- Upholstered Arm Panels with No Arm Caps comes Standard
- Must specify European Beech or American Ash if Wood Arm Caps are specified
- Plastic Glide comes Standard with Glider Mechanism
- Clean-Thru Design
- NOTE: Because of the unique Color of Ash Hardwoods, Stains are a slightly different Color than they appear on the Standard European Beech Hardwoods. If pairing with a Product using Species other than Ash the Stains will appear different. For additional information please contact your Customer Service Representative.

GLIDER

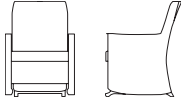

w	outside			sw	seat			seat to top of arm	arm height	weight lbs.	cubic feet
	d	h			sd	sh					
26.5	27.25	39.25		21	19.75	19.5	6.75	26.5	77	22	

model	yds com (54")	sq ft col	com 1	col 2	3	4	5	6	7	8	9	10	11	12	13	14	15	L1	L2	L3
1616	4.25	n/a	1,817	1,887	1,967	2,067	2,207	2,407	2,606	2,806	3,006	3,206	3,406	3,606	3,805	4,005	4,205	2,674	2,875	3,073

OPTIONS

Wood Species	Arm Caps	Seat Back	Fabric 1
Standard X9 No Selection of Option	Standard X9 No Arm Cap	Standard X9 No Selection of Option	Selection Required
A8S European Beech A8T American Ash NOTE: Select wood species when A3 wood arm cap option is specified	A3 Wood (specify finish) Poly \$147 pair DIN Black DIM Taupe DIP Grey Solid Surface \$435 pair CWS Cameo White MWS Modern White CSS Concrete DMS Deep Mink	L4 Back Bump Guard \$183	Fabric: Grade, Vendor, Pattern, Color NOTE: For multiple fabric applications see page 14 for information and pricing

HOW TO ORDER

SPECIFY: Wood species (if applicable) | arm caps | arm cap finish (if applicable) | seat back | textile pattern and color. See pages 5-14 for information and options on moisture barrier, CAL133, upholstery applications, a complete offering of finishes and ordering details.

MODEL NUMBER

1616

Wood Species	Arm Caps	Seat Back	Fabric 1
A8S	A3 - MNW	L4	Grade 5, Momentum, Row, Breeze

ORCHESTRA PATIENT CHAIR STANDARD FEATURES

- 1455-MOTION Mechanism Design Specific with up to 8° of Smooth Travel
- Clean-Thru Design
- Upholstered Seat and Back
- European Beech Exterior Frame
- European Beech Open Arm Frame with Arm Cap
- Wall-Saver Design
- Field Replaceable Components
- Non-Marring Adjustable Glides

STATIONARY PATIENT CHAIR

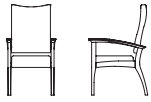

w	outside			sw	seat			seat to top of back	arm height	weight lbs.	cubic feet
	d	h			sd	sh					
24	29	44		21	19	18	23	25.5	45	24	

model	yds com (54")	sq ft col	com 1	col 2	3	4	5	6	7	8	9	10	11	12	13	14	15	L1	L2	L3
1455	1.5	n/a	1,302	1,327	1,355	1,390	1,440	1,510	1,581	1,651	1,722	1,792	1,863	1,933	2,004	2,074	2,145	1,622	1,694	1,763

MOTION PATIENT CHAIR

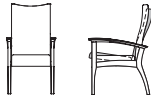

w	outside			sw	seat			seat to top of back	arm height	weight lbs.	cubic feet
	d	h			sd	sh					
24	29	44		21	19	18	23	25.5	45	24	

model	yds com (54")	sq ft col	com 1	col 2	3	4	5	6	7	8	9	10	11	12	13	14	15	L1	L2	L3
1455-MOTION	2.25	n/a	1,669	1,706	1,748	1,801	1,875	1,981	2,087	2,193	2,299	2,404	2,510	2,616	2,722	2,828	2,933	2,136	2,242	2,347

OPTIONS

Arm Caps	Finish	Seat Back	Removable Covers	Fabric 1
Standard A3 Wood	Selection Required	Standard X9 No Selection of Option	Standard X9 No Selection of Option	Selection Required
A4 Poly (black) \$185 pair	See page 9 for full list of finish options	L4 Back Bump Guard \$183	Available on 1455 only H7 Removable Seat and Back Covers \$196 B1L Removable Seat Cover only \$98 B1M Removable Back Cover only \$98	Fabric: Grade, Vendor, Pattern, Color NOTE: For multiple fabric applications see page 14 for information and pricing

HOW TO ORDER

SPECIFY: Arm caps | wood finish | seat back | removable covers | textile pattern and color. See pages 5-14 for information and options on moisture barrier, CAL133, upholstery applications, a complete offering of finishes and ordering details.

MODEL NUMBER

1455

Arm Caps	Finish	Seat Back	Removable Covers	Fabric 1
A4	MLC	L4	H7	Grade 5, Momentum, Row, Breeze

REIN+ PATIENT STANDARD FEATURES

- Rated to 500 lbs.
- European Beech Hardwood Frame
- Mortise-and-Tenon Construction
- Clean-Thru Design
- Field Replaceable Components
- Wall-Saver Design
- Non-Marring Adjustable Glides

STATIONARY PATIENT CHAIR

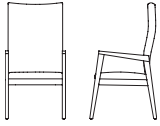

w	outside d	h	sw	seat sd	sh	seat to top of back	arm height	weight lbs.	cubic feet
22.75	25.25	44	20.25	20	17.5	26.5	25.5	26	24

model	yds com (54")	sq ft col	com 1	col 2	3	4	5	6	7	8	9	10	11	12	13	14	15	L1	L2	L3
1825	2	n/a	846	879	917	964	1,029	1,123	1,217	1,312	1,406	1,500	1,594	1,688	1,782	1,876	1,970	1,264	1,359	1,452

MOTION BACK PATIENT CHAIR

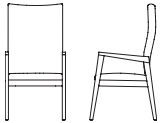

w	outside d	h	sw	seat sd	sh	seat to top of back	arm height	weight lbs.	cubic feet
22.75	25.25	44.5	20.25	20	17.5	26.5	25.5	36	24

model	yds com (54")	sq ft col	com 1	col 2	3	4	5	6	7	8	9	10	11	12	13	14	15	L1	L2	L3
1825-M	2	n/a	1,507	1,544	1,586	1,639	1,713	1,819	1,925	2,031	2,137	2,242	2,348	2,454	2,560	2,666	2,771	1,974	2,080	2,185

OPTIONS

Arm Caps	Finish	Removable Covers	Fabric 1
Standard X9 No Arm Cap	Selection Required	Standard X9 No Selection of Option	Selection Required
Resin \$101 pair DIN Black DIM Taupe DIP Grey Solid Surface \$93 per arm CWS Cameo White MWS Modern White CSS Concrete DMS Deep Mink	See page 9 for full list of finish options	BIL Removable Seat Cover only \$98	Fabric: Grade, Vendor, Pattern, Color NOTE: For multiple fabric applications see page 14 for information and pricing

HOW TO ORDER

SPECIFY: Arm caps | wood finish | removable covers | textile pattern and color. See pages 5-14 for information and options on moisture barrier, CAL133, upholstery applications, a complete offering of finishes and ordering details.

MODEL NUMBER

1825

Arm Caps	Finish	Removable Covers	Fabric 1
DIN	MLC	BIL	Grade 5, Momentum, Row, Breeze

REIN+ PATIENT STANDARD FEATURES

- Rated to 500 lbs.
- European Beech Hardwood Frame
- Mortise-and-Tenon Construction
- Clean-Thru Design
- Field Replaceable Components
- Wall-Saver Design
- Non-Marring Adjustable Glides

STATIONARY EASY ACCESS CHAIR

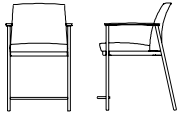

w	outside d	h	sw	seat sd	sh	seat to top of back	arm height	weight lbs.	cubic feet
22.75	27	39.5	20.25	20	24	15	8.5	28	24

model	yds com (54")	sq ft col	com 1	col 2	3	4	5	6	7	8	9	10	11	12	13	14	15	L1	L2	L3
1875	1.5	n/a	916	941	969	1,004	1,054	1,124	1,195	1,265	1,336	1,406	1,477	1,547	1,618	1,688	1,759	1,236	1,308	1,377

MOTION SEAT EASY ACCESS CHAIR

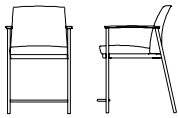

w	outside d	h	sw	seat sd	sh	seat to top of back	arm height	weight lbs.	cubic feet
22.75	25.25	39.5	20.25	20	24	15	8.5	37	24

model	yds com (54")	sq ft col	com 1	col 2	3	4	5	6	7	8	9	10	11	12	13	14	15	L1	L2	L3
1875-M	1.75	n/a	1,492	1,521	1,554	1,595	1,652	1,735	1,817	1,899	1,982	2,064	2,146	2,229	2,311	2,393	2,475	1,861	1,944	2,026

OPTIONS

Arm Caps	Finish	Foot Rest	Removable Covers	Fabric 1
Standard X9 No Arm Cap	Selection Required	Selection Required	Standard X9 No Selection of Option	Selection Required
Resin \$50 per arm D1N Black D1M Taupe D1P Grey Solid Surface \$93 per arm CWS Cameo White MWS Modern White CSS Concrete DMS Deep Mink	See page 9 for full list of finish options	C7V Black C8B Taupe C8A Grey	B1L Removable Seat Cover only \$101	Fabric: Grade, Vendor, Pattern, Color NOTE: For multiple fabric applications see page 14 for information and pricing

HOW TO ORDER

SPECIFY: Arm caps | wood finish | removable covers | textile pattern and color. See pages 5-14 for information and options on moisture barrier, CAL133, upholstery applications, a complete offering of finishes and ordering details.

MODEL NUMBER

1825

Arm Caps	Finish	Foot Rest	Removable Covers	Fabric 1
D1N	MLC		B1L	Grade 5, Momentum, Row, Breeze

RULE OF THREE PATIENT SEATING STANDARD FEATURES

- 3/4" Tubular Bent Luster Grey Powder Coated Metal Frame
- Black Resin Arm Cap
- European Beech Wood Arm Cap is Optional
- Upholstered Seat and Back
- Spring Seat Construction
- Clean-Thru Design
- Wall-Saver Design
- Tight Cushion
- White Plastic Glide fitted into the Bottom of Tubular Leg
- Field Replaceable Components

PATIENT CHAIR



w	outside d	h	sw	seat sd	sh	seat to top of back	arm height	weight lbs.	cubic feet
23.5	25	45	21.25	18.5	18.5	24	25.5	41	27

model	yds com (54")	sq ft col	com 1	col 2	3	4	5	6	7	8	9	10	11	12	13	14	15	L1	L2	L3
1395	2.25	n/a	1,046	1,083	1,125	1,178	1,252	1,358	1,464	1,570	1,676	1,781	1,887	1,993	2,099	2,205	2,310	1,513	1,619	1,724

OPTIONS

Arm Caps	Powder Coat	Removable Covers	Fabric 1
Standard DIN Black Resin	Standard MSL Luster Grey	Standard X9 No Selection of Option	Selection Required
A3 Wood (specify finish) \$74 pair	BWT Bone White BUFF Buff CHLK Chalk SGLD Gold GRPH Graphite MSL Luster Grey HIP Oiled Bronze BKO Onyx POLR Polar SBRZ Soft Bronze HIF Warm Grey	H7 Removable Seat and Back Covers \$196 B1L Removable Seat Cover only \$98 B1M Removable Back Cover only \$98	Fabric: Grade, Vendor, Pattern, Color NOTE: For multiple fabric applications see page 14 for information and pricing

HOW TO ORDER

SPECIFY: Arm caps | arm cap finish (if applicable) | powder coat | removable covers | textile pattern and color. See pages 5-14 for information and options on moisture barrier, CAL133, upholstery applications, a complete offering of finishes and ordering details.

MODEL NUMBER			
1395			
Arm Caps	Powder Coat	Removable Covers	Fabric 1
A3 - MBM	MSL	H7	Grade 5, Momentum, Row, Breeze

SAVEN ROCKER STANDARD FEATURES

- Upholstered Seat and Back
- Polished Aluminum Cast Legs
- Clean-Thru Design
- Wall-Saver Legs
- Stationary Arms Standard without Arm Caps
- Black Rubber Flooring Track

ROCKER

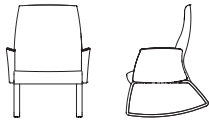

w	outside d	h	sw	seat sd	sh	arm height	weight lbs.	cubic feet
30.75	29.5	40.5	24.5	20	16.75	24.75	60	22

model	yds com (54")	sq ft col	com 1	col 2	3	4	5	6	7	8	9	10	11	12	13	14	15	L1	L2	L3
1476W	3.25	n/a	1,572	1,625	1,687	1,763	1,870	2,023	2,176	2,328	2,481	2,634	2,787	2,940	3,093	3,245	3,398	2,234	2,388	2,539

HIGH BACK ROCKER

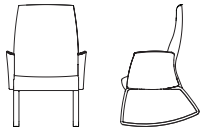

w	outside d	h	sw	seat sd	sh	arm height	weight lbs.	cubic feet
30.75	29.5	46.5	24.5	20	16.75	24.75	63	22

model	yds com (54")	sq ft col	com 1	col 2	3	4	5	6	7	8	9	10	11	12	13	14	15	L1	L2	L3
1480W	3.75	n/a	1,694	1,756	1,826	1,914	2,038	2,214	2,391	2,567	2,743	2,920	3,096	3,272	3,449	3,625	3,801	2,453	2,631	2,805

LITE ROCKER

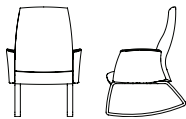

w	outside d	h	sw	seat sd	sh	arm height	weight lbs.	cubic feet
27.75	29.5	40.5	21.5	20	16.75	24.75	57	22

model	yds com (54")	sq ft col	com 1	col 2	3	4	5	6	7	8	9	10	11	12	13	14	15	L1	L2	L3
1476	3	n/a	1,293	1,342	1,399	1,469	1,568	1,709	1,850	1,991	2,132	2,273	2,415	2,556	2,697	2,838	2,979	1,906	2,048	2,188

LITE/HIGH BACK ROCKER

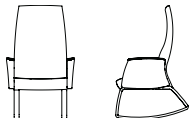

w	outside d	h	sw	seat sd	sh	arm height	weight lbs.	cubic feet
27.75	29.5	46.5	21.25	20	16.75	24.75	60	22

model	yds com (54")	sq ft col	com 1	col 2	3	4	5	6	7	8	9	10	11	12	13	14	15	L1	L2	L3
1480	3.25	n/a	1,496	1,549	1,611	1,687	1,794	1,947	2,100	2,252	2,405	2,558	2,711	2,864	3,017	3,169	3,322	2,158	2,312	2,463

OPTIONS

Arm Caps	Legs	Head Pillow (1480 & 1480W only)	Fabric 1	Fabric 2
X9 None - Standard	PAL Polished Aluminum - Standard	X9 None - Standard	Fabric: Grade, Vendor, Pattern, Color	Fabric: Grade, Vendor, Pattern, Color
A3 Wood \$80 pair Specify Finish	BWT Bone White BUFF Buff CHLK Chalk SGLD Gold GRPH Graphite MSL Luster Grey HIP Oiled Bronze BKO Onyx POLR Polar SBRZ Soft Bronze HIF Warm Grey	GIF Adjustable Head Pillow		NOTE: For multiple fabric application see page 14 for information and pricing.
Poly \$50 pair DIN Black DIM Taupe DIP Grey				
Solid Surface \$460 pair CWS Cameo White MWS Modern White CSS Concrete DMS Deep Mink				

Head Pillow Options GIF

yds com (54")	sq ft col	com 1	col 2	3	4	5	6	7	8	9	10	11	12	13	14	15	L1	L2	L3
0.5	n/a	110	118	128	139	156	179	203	226	250	273	297	320	344	367	391	236	269	282

HOW TO ORDER

SPECIFY: Arm caps | Legs | Head Pillow | Fabric 1 | Fabric 2

MODEL NUMBER

1476

Arm Caps	Legs	Head Pillow	Fabric 1	Fabric 2
X9	X9	GIF	Grade 4, Momentum, Row, Breeze	Grade 4, Momentum, Row, Breeze

SAVEN ROCKER STANDARD FEATURES

- Upholstered Seat and Back
- Polished Aluminum Cast Legs
- Clean-Thru Design
- Wall-Saver Legs
- Motion Arm Articulation from Standard Arm Height: 2.5" Up/1.5" Down
- Black Rubber Flooring Track

ROCKER

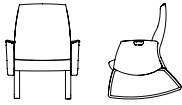

w	outside d	h	sw	seat sd	sh	arm height	weight lbs.	cubic feet
30.75	29.5	40.5	24.5	20	16.75	24.75	60	22

model	yds com (54")	sq ft col	com 1	col 2	3	4	5	6	7	8	9	10	11	12	13	14	15	L1	L2	L3
1476W-MA	3.25	n/a	1,772	1,825	1,887	1,963	2,070	2,223	2,376	2,528	2,681	2,834	2,987	3,140	3,293	3,445	3,598	2,434	2,588	2,739

HIGH BACK ROCKER

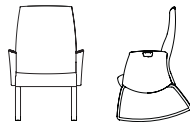

w	outside d	h	sw	seat sd	sh	arm height	weight lbs.	cubic feet
30.75	29.5	46.5	24.5	20	16.75	24.75	63	22

model	yds com (54")	sq ft col	com 1	col 2	3	4	5	6	7	8	9	10	11	12	13	14	15	L1	L2	L3
1480W-MA	3.75	n/a	1,894	1,956	2,026	2,114	2,238	2,414	2,591	2,767	2,943	3,120	3,296	3,472	3,649	3,825	4,001	2,653	2,831	3,005

LITE ROCKER

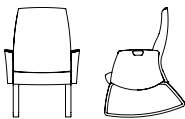

w	outside d	h	sw	seat sd	sh	arm height	weight lbs.	cubic feet
27.75	29.5	40.5	21.5	20	16.75	24.75	57	22

model	yds com (54")	sq ft col	com 1	col 2	3	4	5	6	7	8	9	10	11	12	13	14	15	L1	L2	L3
1476-MA	3	n/a	1,493	1,542	1,599	1,669	1,768	1,909	2,050	2,191	2,332	2,473	2,615	2,756	2,897	3,038	3,179	2,106	2,248	2,388

LITE/HIGH BACK ROCKER

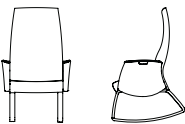

w	outside d	h	sw	seat sd	sh	arm height	weight lbs.	cubic feet
27.75	29.5	46.5	21.25	20	16.75	24.75	60	22

model	yds com (54")	sq ft col	com 1	col 2	3	4	5	6	7	8	9	10	11	12	13	14	15	L1	L2	L3
1480-MA	3.25	n/a	1,696	1,749	1,811	1,887	1,994	2,147	2,300	2,452	2,605	2,758	2,911	3,064	3,217	3,369	3,522	2,358	2,512	2,663

OPTIONS

Arm Caps	Legs	Motion Arm Lever	Head Pillow (1480-MA & 1480W-MA only)	Fabric 1	Fabric 2
A3 Wood - Standard Specify Finish Poly \$50 pair DIN Black DIM Taupe DIP Grey Solid Surface \$460 pair CWS Cameo White MWS Modern White CSS Concrete DMS Deep Mink	PAL Polished Aluminum - Standard BWT Bone White BUFF Buff CHLK Chalk SGLD Gold GRPH Graphite MSL Luster Grey HIP Oiled Bronze BKO Onyx POLR Polar SBRZ Soft Bronze HIF Warm Grey	Specify Color H6M Black H6N Taupe H6P Grey	X9 None - Standard GIF Adjustable Head Pillow	Fabric: Grade, Vendor, Pattern, Color	Fabric: Grade, Vendor, Pattern, Color NOTE: For multiple fabric application see page 14 for information and pricing.

Head Pillow Options GIF	yds com (54")	sq ft col	com 1	col 2	3	4	5	6	7	8	9	10	11	12	13	14	15	L1	L2	L3
	0.5	n/a	110	118	128	139	156	179	203	226	250	273	297	320	344	367	391	236	269	282

HOW TO ORDER
SPECIFY: Arm caps | Legs | Motion Arm Lever | Head Pillow | Fabric 1 | Fabric 2

MODEL NUMBER					
1476					
Arm Caps	Legs	Motion Arm Lever	Head Pillow	Fabric 1	Fabric 2
X9	X9	H6M	GIF	Grade 4, Momentum, Row, Breeze	Grade 4, Momentum, Row, Breeze

OTTOMAN STANDARD FEATURES

- Slanted Top - Upholstered, Poly or Solid Surface
- Luster Grey Powder Coat on all Exposed Metal
- Black Rubber Flooring Track

OTTOMAN, UPHOLSTERED TOP

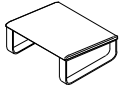

w	outside d	h	weight lbs.	cubic feet
16	14	7	20	13

model	yds com (54")	sq ft col	com 1	col 2	3	4	5	6	7	8	9	10	11	12	13	14	15	L1	L2	L3
1481	0.75	n/a	450	462	476	494	519	554	589	625	660	695	730	766	801	836	871	624	660	695

OTTOMAN, POLY TOP

model	w	d	h	wt	cu ft	list
1481-P	16	14	7	20	13	\$ 475

OTTOMAN, SOLID SURFACE TOP

model	w	d	h	wt	cu ft	list
1481-S	16	14	7	20	13	\$ 750

OPTIONS

Powder Coat	Top	Fabric
Standard MSL Luster Grey	Selection Required	Selection Required
MSL Luster Grey - Standard	1481 Upholstered	Fabric: Grade, Vendor, Pattern, Color
BWT Bone White BUFF Buff CHLK Chalk SGLD Gold GRPH Graphite MSL Luster Grey HIP Oiled Bronze BKO Onyx POLR Polar SBRZ Soft Bronze HIF Warm Grey	1481-P Poly D1N Black D1M Taupe D1P Grey 1481-S Solid Surface CWS Cameo White MWS Modern White CSS Concrete DMS Deep Mink	NOTE: For multiple fabric application see page 14 for information and pricing

HOW TO ORDER

SPECIFY: Powder coat | top | textile pattern and color. See pages 5-14 for information and options on moisture barrier, CAL133, upholstery applications, a complete offering of finishes and ordering details.

MODEL NUMBER

1481

Powder Coat	Top	Fabric
MSL	D1N	Grade 5, Momentum, Row, Breeze

SERONY PATIENT STANDARD FEATURES

- Upholstered Seat and Back
- Clean-Thru Design
- Wall-Saver Design
- Tight Cushion
- Luster Grey Powder Coat on all Exposed Metal
- Poly Arm Caps (specify color)
- Non-Marring Adjustable Glides

PATIENT CHAIR

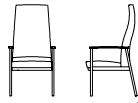

w	outside d	h	sw	seat sd	sh	seat to top of back	arm height	weight lbs.	cubic feet
25	26	46.5	21.5	20	18	15.25	25	55	24

model	yds com (54")	sq ft col	com 1	col 2	3	4	5	6	7	8	9	10	11	12	13	14	15	L1	L2	L3
1478	2.25	n/a	1,066	1,103	1,145	1,198	1,272	1,378	1,484	1,590	1,696	1,801	1,907	2,013	2,119	2,225	2,330	1,533	1,639	1,744

MOTION BACK PATIENT CHAIR

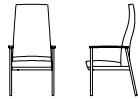

w	outside d	h	sw	seat sd	sh	seat to top of back	arm height	weight lbs.	cubic feet
25	26	46.5	21.5	20	18	15.25	25	65	24

model	yds com (54")	sq ft col	com 1	col 2	3	4	5	6	7	8	9	10	11	12	13	14	15	L1	L2	L3
1478-M	2.25	n/a	1,702	1,739	1,781	1,834	1,908	2,014	2,120	2,226	2,332	2,437	2,543	2,649	2,755	2,861	2,966	2,169	2,275	

OPTIONS

Arm Caps	Powder Coat	Fabric 1
Standard DIN Black Poly	Standard MSL Luster Grey	Selection Required
DIM Taupe Poly DIP Grey Poly A3 Wood (specify finish) Solid Surface \$220 pair CWS Cameo White MWS Modern White CSS Concrete DMS Deep Mink	BWT Bone White BUFF Buff CHLK Chalk SGLD Gold GRPH Graphite MSL Luster Grey HIP Oiled Bronze BKO Onyx POLR Polar SBRZ Soft Bronze HIF Warm Grey	Fabric : Grade, Vendor, Pattern, Color NOTE: For multiple fabric applications see page 14 for information and pricing

HOW TO ORDER

SPECIFY: Arm caps | arm cap finish (if applicable) | powder coat | textile pattern and color. See pages 5-14 for information and options on moisture barrier, CAL133, upholstery applications, a complete offering of finishes and ordering details

MODEL NUMBER

1478

Arm Caps	Powder Coat	Fabric 1
DIN	MSL	Grade 5, Momentum, Row, Breeze

SERONY PATIENT STANDARD FEATURES

- Upholstered Seat and Back
- Wall-Saver Design
- Clean-Thru Design
- Tight Cushion
- Luster Grey Powder Coat on all Exposed Metal
- Black Poly Arm Caps
- Non-Marring Adjustable Glides
- Polyurethane Coated Steel Foot Rest (specify color)

EASY ACCESS CHAIR

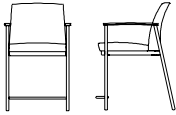

w	outside d	h	sw	seat sd	sh	seat to top of back	arm height	weight lbs.	cubic feet
25	26	40.5	21.5	17.5	23.75	15.25	25	60	24

model	yds com (54")	sq ft col	com 1	col 2	3	4	5	6	7	8	9	10	11	12	13	14	15	L1	L2	L3
1474	1.5	n/a	1,163	1,188	1,216	1,251	1,301	1,371	1,442	1,512	1,583	1,653	1,724	1,794	1,865	1,935	2,006	1,483	1,555	1,624

OPTIONS

Arm Caps	Powder Coat	Foot Rest	Fabric 1
Standard DIN Black Poly Arm Cap	Standard MSL Luster Grey	Selection Required	Selection Required
DIM Taupe Poly D1P Grey Poly A3 Wood Arm Caps (specify finish) Solid Surface \$220 pair CWS Cameo White MWS Modern White CSS Concrete DMS Deep Mink	BWT Bone White BUFF Buff CHLK Chalk SGLD Gold GRPH Graphite MSL Luster Grey HIP Oiled Bronze BKO Onyx POLR Polar SBRZ Soft Bronze HIF Warm Grey	C7V Black C8B Taupe C8A Grey	Fabric : Grade, Vendor, Pattern, Color NOTE: For multiple fabric applications see page 14 for information and pricing

HOW TO ORDER

SPECIFY: Arm Caps | arm cap finish (if applicable) | powder coat | removable covers | textile pattern and color. See pages 5-14 for information and options on moisture barrier, CAL133, upholstery applications, a complete offering of finishes and ordering details.

MODEL NUMBER

1474

Arm Caps	Legs	Foot Rest	Fabric 2
DIN	MSL	C7V	Grade 5, Momentum, Row, Breeze

SERONY PATIENT STANDARD FEATURES

- Slanted Upholstered Top
- Luster Grey POWder Coat on all Exposed Metal
- Tight Cushion
- Non-Marring Adjustable Glides

PATIENT OTTOMAN

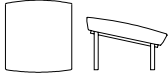

outside			seat			seat to top of back	arm height	weight lbs.	cubic feet
w	d	h	sw	sd	sh				
18	18.75	13.5	18	18.75	13.5	N/A	N/A	12	6

model	yds com (54")	sq ft col	com 1	col 2	3	4	5	6	7	8	9	10	11	12	13	14	15	L1	L2	L3
1479	0.75	n/a	450	462	476	494	519	554	589	625	660	695	730	766	801	836	871	624	660	695

OPTIONS

Powder Coat	Fabric 1
Standard	Selection Required
MSL Luster Grey	
BWT Bone White BUFF Buff CHLK Chalk SGLD Gold GRPH Graphite MSL Luster Grey HIP Oiled Bronze BKO Onyx POLR Polar SBRZ Soft Bronze HIF Warm Grey	Fabric: Grade, Vendor, Pattern, Color NOTE: For multiple fabric application see page 14 for information and pricing

HOW TO ORDER

SPECIFY: Powder coat | removable covers | textile pattern and color. See pages 5-14 for information and options on moisture barrier, CAL133, upholstery applications, a complete offering of finishes and ordering details.

MODEL NUMBER

1479

Powder Coat	Fabric 1
MSL	Grade 5, Momentum, Row, Breeze

SILVR ION METAL PATIENT STANDARD FEATURES

- 360° Clean-Thru Design
- Upholstered Seat and Back
- European Beech Arm Caps
- Warm Grey (with Silver Ion Antimicrobial) Powder Coat on all Exposed Metal is Standard
- Wall-Saver Design
- European Beech Arm Caps and Overlay on Legs
- Non-Marring Adjustable Glides

PATIENT CHAIR

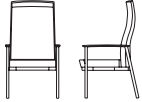

outside			seat			seat to top of back	arm height	weight lbs.	cubic feet
w	d	h	sw	sd	sh				
25	26	46	21	18.5	19	27	25	65	25

model	yds com (54")	sq ft col	com 1	col 2	3	4	5	6	7	8	9	10	11	12	13	14	15	L1	L2	L3
1477	2.5	n/a	1,244	1,285	1,332	1,391	1,473	1,591	1,708	1,826	1,943	2,061	2,179	2,296	2,414	2,531	2,649	1,759	1,878	1,994

OPTIONS

Arm Caps	Finish	Powder Coat	Fabric 1
Standard A3 Wood	Standard X9 No Selection of Option	Standard H1F Warm Grey (with Silver Ion Antimicrobial)	Selection Required
D1N Poly (black) D1M Poly (taupe) D1P Poly (grey)	See page 9 for full list of finish options NOTE: Select finish when 1447 model or A3 wood arm cap option is specified	See page 9 for full list of powder coat options NOTE: Any other powder coat specified will not have Silver Ion antimicrobial technology	Fabric: Grade, Vendor, Pattern, Color NOTE: For multiple fabric applications see page 14 for information and pricing

HOW TO ORDER

SPECIFY: Arm caps | finish (if applicable) | powder coat | removable covers | textile pattern and color. See pages 5-14 for information and options on moisture barrier, CAL133, upholstery applications, a complete offering of finishes and ordering details.

MODEL NUMBER

1477

Arm Caps	Finish	Powder Coat	Fabric 1
D1N	MLC	H1F	Grade 5, Momentum, Row, Breeze

SILVR ION WOOD PATIENT STANDARD FEATURES

- 360° Clean-Thru Design
- Upholstered Seat and Back
- Warm Grey (with Silver Ion Antimicrobial) Powder Coat on all Exposed Metal is Standard
- Wall-Saver Design
- Non-Marring Adjustable Glides

PATIENT CHAIR (SILVR ION WOOD)

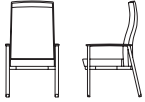

w	outside d	h	sw	seat sd	sh	seat to top of back	arm height	weight lbs.	cubic feet
25	26	46	21	18.5	19	27	25	65	25

model	yds com (54")	sq ft col	com 1	col 2	3	4	5	6	7	8	9	10	11	12	13	14	15	L1	L2	L3
1447	2.5	n/a	1,667	1,708	1,755	1,814	1,896	2,014	2,131	2,249	2,366	2,484	2,602	2,719	2,837	2,954	3,072	2,182	2,301	2,417

OPTIONS

Arm Caps	Finish	Powder Coat	Arm Panel	Fabric 1
Standard A3 Wood	Standard X9 No Selection of Option	Standard HIF Warm Grey (with Silver Ion Antimicrobial)	Standard X9 No Selection of Option	Selection Required
DIN Poly (black) DIM Poly (taupe) DIP Poly (grey)	See page 9 for full list of finish options NOTE: Select finish when 1447 model or A3 wood arm cap option is specified	See page 9 for full list of powder coat options NOTE: Any other powder coat specified will not have Silver Ion antimicrobial technology	Available on 1447 only WAP Pair of Wood (specify finish) \$418 UAP Pair of Upholstered (specify textile) (see pricing below)	Fabric: Grade, Vendor, Pattern, Color NOTE: For multiple fabric applications see page 14 for information and pricing

Arm Panel Options

yds com (54")	sq ft col	com 1	col 2	3	4	5	6	7	8	9	10	11	12	13	14	15	L1	L2	L3
0.75	n/a	528	540	554	572	597	632	667	703	738	773	808	844	879	914	949	702	738	773

HOW TO ORDER

SPECIFY: Arm caps | finish (if applicable) | powder coat | removable covers | arm panels (if applicable) | textile pattern and color. See pages 5-14 for information and options on moisture barrier, CAL133, upholstery applications, a complete offering of finishes and ordering details.

MODEL NUMBER

1447

Arm Caps	Finish	Powder Coat	Arm Panel	Fabric 1
DIN	MLC	HIF	WAP - MLC	Grade 5, Momentum, Row, Breeze

VOYAGE PATIENT CHAIR STANDARD FEATURES

- 1525-MOTION Mechanism Design Specific with up to 8° of Smooth Travel
- Clean-Thru Design
- Field Replaceable Components
- Upholstered Seat and Back
- European Beech Exterior Frame
- Non-Marring Adjustable Glides

PATIENT CHAIR

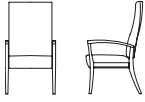

w	outside d	h	sw	seat sd	sh	seat to top of back	arm height	weight lbs.	cubic feet
24	26.5	43.5	21	19	18	23	25.5	45	25

model	yds com (54")	sq ft col	com 1	col 2	3	4	5	6	7	8	9	10	11	12	13	14	15	L1	L2	L3
1525	2.25	n/a	1,158	1,195	1,237	1,290	1,364	1,470	1,576	1,682	1,788	1,893	1,999	2,105	2,211	2,317	2,422	1,625	1,731	1,836

MOTION PATIENT CHAIR

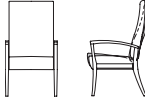

w	outside d	h	sw	seat sd	sh	seat to top of back	arm height	weight lbs.	cubic feet
24	26.5	43.5	21	19	18	23	25.5	45	25

model	yds com (54")	sq ft col	com 1	col 2	3	4	5	6	7	8	9	10	11	12	13	14	15	L1	L2	L3
1525-MOTION	2.25	n/a	1,668	1,705	1,747	1,800	1,874	1,980	2,086	2,192	2,298	2,403	2,509	2,615	2,721	2,827	2,932	2,135	2,241	2,346

OPTIONS

Arm Caps	Seat Back	Removable Covers	Fabric 1
Standard X9 No Arm Cap	Standard X9 No Selection of Option	Standard X9 No Selection of Option	Selection Required
A4 Poly (black) \$185 pair	L4 Back Bumper Guard \$183	Available on 1525 only H7 Removable Seat and Back Covers \$196 B1L Removable Seat Cover only \$98 B1M Removable Back Cover only \$98	Fabric: Grade, Vendor, Pattern, Color NOTE: For multiple fabric applications see page 14 for information and pricing

HOW TO ORDER

SPECIFY: Arm caps | wood finish | removable covers | textile pattern and color. See pages 5-14 for information and options on moisture barrier, CAL133, upholstery applications, a complete offering of finishes and ordering details.

MODEL NUMBER

1525

Arm Caps	Seat Back	Removable Covers	Fabric 1
A4	L4	H7	Grade 5, Momentum, Row, Breeze

OTTOMAN STANDARD FEATURES

- Slanted Upholstered Top
- Maple Exterior Frame and Legs
- Non-Marring Plastic Tack-In Glides

OTTOMAN



model	w	d	h	wt	cu ft
1112	20	19	12	20	4

yds com (54")	sq ft col	com 1	col 2	3	4	5	6	7	8	9	10	11	12	13	14	15	L1	L2	L3
1	n/a	572	588	607	631	664	711	758	805	852	899	946	993	1,040	1,087	1,134	795	842	889

OPTIONS

Finish	Fabric 1
Selection Required	Selection Required
See page 9 for full list of finish options	Fabric: Grade, Vendor, Pattern, Color NOTE: For multiple fabric applications see page 14 for information and pricing

HOW TO ORDER

SPECIFY: Wood finish | textile pattern and color. See **pages 5-14** for information and options on moisture barrier, CAL133, upholstery applications, a complete offering of finishes and ordering details.

MODEL NUMBER

1112

Finish	Fabric 1
MLC	Grade 5, Momentum, Row, Breeze

HUG BARIATRIC STANDARD FEATURES

- Upholstered Seat and Back
- European Beech Frame
- Clean-Thru Design
- Wall-Saver Design
- Rated to 500 lbs.
- Detailed Seams
- Non-Marring Adjustable Glides

BARIATRIC CHAIR

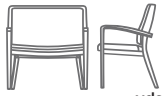

w	outside d	h	sw	seat sd	sh	seat to top of back	arm height	weight lbs.	cubic feet
33.5	26	36.5	30	19	19	17.5	27	25.5	19

model	yds com (54")	sq ft col	com 1	col 2	3	4	5	6	7	8	9	10	11	12	13	14	15	L1	L2	L3
1215-OB	2.25	n/a	1,286	1,323	1,365	1,418	1,492	1,598	1,704	1,810	1,916	2,021	2,127	2,233	2,339	2,445	2,550	1,753	1,859	1,964

OPTIONS

Finish	Arm Cap	Fabric 1	Fabric 2
Selection Required	Standard X9 No Arm Cap	Selection Required	Selection Required
See page 9 for full list of finish options	Resin Pair \$52 D1N Black D1M Taupe D1P Grey Solid Surface Pair \$485 CWS Cameo White MWS Modern White CSS Concrete DMS Deep Mink	Fabric: Grade, Vendor, Pattern, Color	Fabric: Grade, Vendor, Pattern, Color NOTE: For multiple fabric applications see page 14 for information and pricing

HOW TO ORDER

SPECIFY: Arm Caps | Finish | Ferrules | Fabric

MODEL NUMBER

1215-OB

Finish	Arm Cap	Fabric 1	Fabric 2
MNW	X9	Grade 5, Momentum, Row, Breeze	Grade 5, Momentum, Row, Breeze

INTERLUDE UPHOLSTERED BACK BARIATRIC STANDARD FEATURES

- Rated for 500 lbs.
- Clean-Thru Design
- Upholstered Seat and Back
- 1922-OB: Upholstered Arm Panel w/ European Beech Arm Cap
- 1922OA-OB: European Beech Open Arm Frame w/ Arm Cap
- Legs made of 1 x 2 16 Gauge Tubing (.06" Wall Thickness)
- Wallsaver Design
- Non-Marring Adjustable Glides
- Field Replaceable Components

UPHOLSTERED BACK W/ UPHOLSTERED ARM PANELS, BARIATRIC CHAIR



w	outside d	h	sw	seat sd	sh	seat to top of back	arm height	weight lbs.	cubic feet
34.5	24.5	36.75	30	18	19	17.75	25.5	47	27

model	yds com (54")	sq ft col	com 1	col 2	3	4	5	6	7	8	9	10	11	12	13	14	15	L1	L2	L3
1922-OB	2.75	n/a	1,727	1,772	1,824	1,889	1,979	2,108	2,238	2,367	2,496	2,626	2,755	2,884	3,014	3,143	3,272	2,291	2,422	2,550

UPHOLSTERED BACK W/ OPEN ARMS BARIATRIC CHAIR

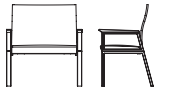

w	outside d	h	sw	seat sd	sh	seat to top of back	arm height	weight lbs.	cubic feet
34.5	24.5	36.75	30	18	19	17.75	25.5	42	27

model	yds com (54")	sq ft col	com 1	col 2	3	4	5	6	7	8	9	10	11	12	13	14	15	L1	L2	L3
1922OA-OB	2.5	n/a	1,747	1,788	1,835	1,894	1,976	2,094	2,211	2,329	2,446	2,564	2,682	2,799	2,917	3,034	3,152	2,262	2,381	2,497

OPTIONS

Arm Caps	Finish	Powder Coat	Removable Covers	Fabric 1
Standard A3 Wood	Standard X9 No Selection of Option	Selection Required	Standard X9 No Selection of Option	Selection Required
A4 Poly (black) \$231 pair	See page 9 for full list of finish options NOTE: Select finish when 1922OA-OB model or A3 wood arm cap option is specified	BWT Bone White BUFF Buff CHLK Chalk SGLD Gold GRPH Graphite MSL Luster Grey HIP Oiled Bronze BKO Onyx POLR Polar SBRZ Soft Bronze HIF Warm Grey	H7 Removable Seat and Back Covers \$196 B1L Removable Seat Cover only \$98 B1M Removable Back Cover only \$98	Fabric: Grade, Vendor, Pattern, Color NOTE: For multiple fabric applications see page 14 for information and pricing

HOW TO ORDER

SPECIFY: Arm finish | wood finish (if applicable) | powder coat | removable covers | textile pattern and color. See pages 5-14 for information and options on moisture barrier, CAL133, upholstery applications, a complete offering of finishes and ordering details.

MODEL NUMBER

1922-OB

Arm Caps	Finish	Powder Coat	Removable Covers	Fabric 1
A3	MLC	BWT	H7	Grade 5, Momentum, Row, Breeze

HEAVY-DUTY GUEST STANDARD FEATURES

- Fully Upholstered Seat and Back
- Fixed Arms
- Floor-Saver Swivel Glides
- Clean-Thru Design
- Heavy-Duty Rated up to 500 lbs. on 30" and 1000 lbs. on 42" with Swivel Glides

BARIATRIC GUEST 30"

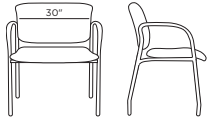

w	outside d	h	sw	seat sd	sh	inside back	arm height	from floor	weight lbs.	cubic feet
34.75	27.75	33	30.75	18.75	18	14.75	n/a	n/a	n/a	28
							fixed black arm pads (BP)	9.5	27.5	61
							fixed silver arm pads (SP)	9.5	27.5	61

- With arms only

model	yds com (54")	sq ft col	com 1	col 2	3	4	5	6	7	8	9	10	11	12	13	14	15	L1	L2	L3
C2439	2.5	50	836	877	924	983	1,065	1,183	1,300	1,418	1,535	1,653	1,771	1,888	2,006	2,123	2,241	1,351	1,470	1,586

BARIATRIC GUEST 42"

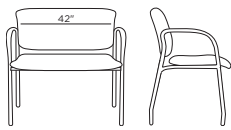

w	outside d	h	sw	seat sd	sh	inside back	arm height	from floor	weight lbs.	cubic feet
46.5	27.75	33	42.5	18.75	18	14.75	n/a	n/a	n/a	36
							fixed black arm pads (BP)	9.5	27.5	80
							fixed silver arm pads (SP)	9.5	27.5	80

- With arms only

model	yds com (54")	sq ft col	com 1	col 2	3	4	5	6	7	8	9	10	11	12	13	14	15	L1	L2	L3
C2449	2.5	50	1,049	1,090	1,137	1,196	1,278	1,396	1,513	1,631	1,748	1,866	1,984	2,101	2,219	2,336	2,454	1,564	1,683	1,799

OPTIONS

Frame	Arm Pads	Glides	Fabric 1	Fabric 2
BF Black SF Silver	 BP Fixed Black Arm Pads - Standard SP Fixed Silver Arm Pads \$32	W37 Floor-Saver Swivel Glides - Standard W38 Felt Tip Swivel Glides \$22	Grade, Vendor, Pattern, Color	Grade, Vendor, Pattern, Color

HOW TO ORDER

SPECIFY: Frame | arms | glides | fabric 1 | fabric 2
See pages 5-14 for information and options on moisture barrier, CAL133, upholstery applications.

MODEL NUMBER

C2439

Frame	Arm Pads	Glides	Fabric 1	Fabric 2
BF	BP	W37	Grade 3, Momentum, Hue, Smoke	Grade 3, Momentum, Epic, Limestone

MODERN AMENITY OPEN ARM/PANEL ARM BARIATRIC CHAIR STANDARD FEATURES

- Rated for 500 lbs.
- Spring Seat Construction
- Clean-Thru Design
- Wall-Saver Design
- Must specify European Beech or American Ash Frame
- Wood Arm Cap
- Non-Marring Adjustable Glides
- Field Replaceable Components
- NOTE: Because of the unique Color of Ash Hardwoods, Stains are a slightly different Color than they appear on the Standard European Beech Hardwoods. If pairing with a Product using Species other than Ash the Stains will appear different. For additional information please contact your Customer Service Representative.

BARIATRIC CHAIR, OPEN ARM



w	outside			sw	seat			seat to top of back	arm height	weight lbs.	cubic feet
	d	h	sd		sh						
33	26	34.5	29.75	22.25	19	15	26.75	55	26		

- Upholstered Seat and Back

model	yds com (54")	sq ft col	com 1	col 2	3	4	5	6	7	8	9	10	11	12	13	14	15	L1	L2	L3
1600-OB	2	n/a	1,512	1,545	1,583	1,630	1,695	1,789	1,883	1,978	2,072	2,166	2,260	2,354	2,448	2,542	2,636	1,930	2,025	2,118

BARIATRIC CHAIR, PANEL ARM

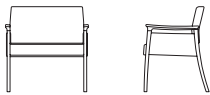

w	outside			sw	seat			seat to top of back	arm height	weight lbs.	cubic feet
	d	h	sd		sh						
33	26	34.5	29.75	22.25	19	15	26.75	59	26		

- Upholstered Arms, Seat and Back

model	yds com (54")	sq ft col	com 1	col 2	3	4	5	6	7	8	9	10	11	12	13	14	15	L1	L2	L3
1610-OB	2.75	n/a	1,605	1,650	1,702	1,767	1,857	1,986	2,116	2,245	2,374	2,504	2,633	2,762	2,892	3,021	3,150	2,169	2,300	2,428

OPTIONS

Wood Species	Arm Caps	Finish	Removable Covers	Fabric 1
Selection Required	Standard A3 Wood Arm Cap	Selection Required	Standard X9 No Selection of Option	Selection Required
A8S European Beech A8T American Ash	Poly \$109 pair D1N Black D1M Taupe D1P Grey Solid Surface \$624 pair CWS Cameo White MWS Modern White CSS Concrete DMS Deep Mink	See page 9 for full list of finish options	H7 Removable Seat and Back Covers \$196 B1L Removable Seat Cover only \$98 B1M Removable Back Cover only \$98	Fabric: Grade, Vendor, Pattern, Color NOTE: For multiple fabric applications see page 14 for information and pricing

HOW TO ORDER

SPECIFY: Wood Species | arm caps | wood finish | removable covers | textile pattern and color. See pages 5-14 for information and options on moisture barrier, CAL133, upholstery applications, a complete offering of finishes and ordering details.

MODEL NUMBER

1600-OB

Wood Species	Arm Caps	Finish	Removable Covers	Fabric 1
A8S	D1N	MLC	H7	Grade 5, Momentum, Row, Breeze

ORCHESTRA BARIATRIC STANDARD FEATURES

- 1408-OB rated for 500 lbs.
- 1408-K rated for 1,000 lbs.
- Clean-Thru Design
- Upholstered Seat and Back
- Open Wood Arm Frame with Wood Arm Cap
- European Beech Exterior Frame
- Field Replaceable Components
- Wall-Saver Design
- Non-Marring Adjustable Glides

BARIATRIC CHAIR



w	outside			sw	seat			seat to top of back	arm height	weight lbs.	cubic feet
	d	h			sd	sh					
34	27.5	34		30	19	18	16.5	25.5	50	26	

model	yds com (54")	sq ft col	com 1	col 2	3	4	5	6	7	8	9	10	11	12	13	14	15	L1	L2	L3
1408-OB	2	n/a	1,478	1,511	1,549	1,596	1,661	1,755	1,849	1,944	2,038	2,132	2,226	2,320	2,414	2,508	2,602	1,896	1,991	2,084

BARIATRIC CHAIR



w	outside			sw	seat			seat to top of back	arm height	weight lbs.	cubic feet
	d	h			sd	sh					
35	27.5	34		30	19	18	16.5	25.5	67	26	

model	yds com (54")	sq ft col	com 1	col 2	3	4	5	6	7	8	9	10	11	12	13	14	15	L1	L2	L3
1408-K	2	n/a	1,810	1,843	1,881	1,928	1,993	2,087	2,181	2,276	2,370	2,464	2,558	2,652	2,746	2,840	2,934	2,228	2,323	2,416

OPTIONS

Arm Caps	Finish	Removable Covers	Fabric 1
Standard X9 No Arm Cap	Selection Required	Standard X9 No Selection of Option	Selection Required
A4 Poly (black) \$185 pair	See page 9 for full list of finish options	H7 Removable Seat and Back Covers \$196 B1L Removable Seat Cover only \$98 B1M Removable Back Cover only \$98	Fabric: Grade, Vendor, Pattern, Color NOTE: For multiple fabric applications see page 14 for information and pricing

HOW TO ORDER

SPECIFY: Arm caps | wood finish | removable covers | textile pattern and color. See pages 5-14 for information and options on moisture barrier, CAL133, upholstery applications, a complete offering of finishes and ordering details.

MODEL NUMBER

1408-OB

Arm Caps	Finish	Removable Covers	Fabric 1
A3	MLC	H7	Grade 5, Momentum, Row, Breeze

REIN+ BARIATRIC STANDARD FEATURES

- Rated to 500 lbs.
- European Beech Hardwood Frame
- Mortise-and-Tenon Construction
- Clean-Thru Design
- Field Replaceable Components
- Wall-Saver Design
- Non-Marring Adjustable Glides
- Can be Ganged to other Rein+ Units using 1810-G or 1810-TG

BARIATRIC CHAIR

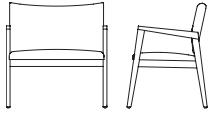

outside			seat			seat to top of back	arm height	weight lbs.	cubic feet
w	d	h	sw	sd	sh				
31.75	25.25	32.5	29.25	20	17.5	15	25.5	35	23

model	yds com (54")	sq ft col	com 1	col 2	3	4	5	6	7	8	9	10	11	12	13	14	15	L1	L2	L3
1810-OB	2	n/a	947	980	1,018	1,065	1,130	1,224	1,318	1,413	1,507	1,601	1,695	1,789	1,883	1,977	2,071	1,365	1,460	1,553

OPTIONS

Arm Caps	Finish	Removable Covers	Fabric 1
Standard X9 No Arm Cap	Selection Required	Standard X9 No Selection of Option	Selection Required
Resin Pair \$101 D1N Black D1M Taupe D1P Grey Solid Surface Pair \$185 CWS Cameo White MWS Modern White CSS Concrete DMS Deep Mink	See page 9 for full list of finish options	B1L Removable Seat Cover only \$98	Fabric: Grade, Vendor, Pattern, Color NOTE: For multiple fabric applications see page 14 for information and pricing

HOW TO ORDER

SPECIFY: Arm caps | wood finish | removable covers | textile pattern and color. See **pages 5-14** for information and options on moisture barrier, CAL133, upholstery applications, a complete offering of finishes and ordering details.

MODEL NUMBER

1810-OB

Arm Caps	Finish	Removable Covers	Fabric 1
D1N	MLC	B1L	Grade 5, Momentum, Row, Breeze

RULE OF THREE BARIATRIC SEATING STANDARD FEATURES

- Rated for 500 lbs.
- 3/4" Tubular Bent Luster Grey Powder Coated Metal Frame
- Black Resin Arm Cap
- Upholstered Seat and Back
- Spring Seat Construction
- Clean-Thru Design
- Wall-Saver Design
- Tight Cushion
- White Plastic Glide fitted into the Bottom of Tubular Leg
- Field Replaceable Components

BARIATRIC CHAIR



w	outside d	h	sw	seat sd	sh	seat to top of back	arm height	weight lbs.	cubic feet
32.25	25	31.75	30	18.5	18.5	13.5	25.5	38	33

model	yds com (54")	sq ft col	com 1	col 2	3	4	5	6	7	8	9	10	11	12	13	14	15	L1	L2	L3
1392-OB	2	n/a	1,138	1,171	1,209	1,256	1,321	1,415	1,509	1,604	1,698	1,792	1,886	1,980	2,074	2,168	2,262	1,556	1,651	1,744

OPTIONS

Arm Caps	Powder Coat	Removable Covers	Fabric 1
Standard DIN Black Resin	Standard MSL Luster Grey	Standard X9 No Selection of Option	Selection Required
A3 Wood (specify finish) \$74 pair	BWT Bone White BUFF Buff CHLK Chalk SGLD Gold GRPH Graphite MSL Luster Grey HIP Oiled Bronze BKO Onyx POLR Polar SBRZ Soft Bronze HIF Warm Grey	H7 Removable Seat and Back Covers \$196 BIL Removable Seat Cover only \$98 BIM Removable Back Cover only \$98	Fabric: Grade, Vendor, Pattern, Color NOTE: For multiple fabric applications see page 14 for information and pricing

HOW TO ORDER

SPECIFY: Arm caps | arm cap finish (if applicable) | powder coat | removable covers | textile pattern and color. See pages 5-14 for information and options on moisture barrier, CAL133, upholstery applications, a complete offering of finishes and ordering details.

MODEL NUMBER

1392-OB

Arm Caps	Powder Coat	Removable Covers	Fabric 1
A3 - MNW	MSL	H7	Grade 5, Momentum, Row, Breeze

SERONY BARIATRIC STANDARD FEATURES

- Upholstered Seat and Back
- Wall-Saver Design
- Clean-Thru Design
- Tight Cushion
- Luster Grey Powder Coat on all Exposed Metal
- Black Poly Arm Caps
- Non-Marring Adjustable Glides

BARIATRIC

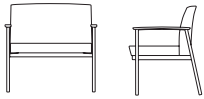

w	outside			seat			seat to top of back	arm height	weight lbs.	cubic feet
	d	h	sw	sd	sh					
34	26	33	30	20	18		15.25	25	58	26

model	yds com (54")	sq ft col	com 1	col 2	3	4	5	6	7	8	9	10	11	12	13	14	15	L1	L2	L3
1472-OB	2	n/a	1,145	1,178	1,216	1,263	1,328	1,422	1,516	1,611	1,705	1,799	1,893	1,987	2,081	2,175	2,269	1,563	1,658	1,751

OPTIONS

Arm Caps	Powder Coat	Fabric 1
Standard DIN Black Poly	Standard MSL Luster Grey	Selection Required
D1M Taupe Poly D1P Grey Poly A3 Wood (specify finish) Solid Surface \$220 pair CWS Cameo White MWS Modern White CSS Concrete DMS Deep Mink	BWT Bone White BUFF Buff CHLK Chalk SGLD Gold GRPH Graphite MSL Luster Grey HIP Oiled Bronze BKO Onyx POLR Polar SBRZ Soft Bronze HIF Warm Grey	Fabric : Grade, Vendor, Pattern, Color NOTE: For multiple fabric applications see page 14 for information and pricing

HOW TO ORDER

SPECIFY: Arm Caps | arm cap finish (if applicable) | powder coat | textile pattern and color. See pages 5-14 for information and options on moisture barrier, CAL133, upholstery applications, a complete offering of finishes and ordering details.

MODEL NUMBER

1472

ARM CAPS	POWDER COAT	FABRIC 1
DIN	MSL	GRADE 5, MOMENTUM, ROW, BREEZE

SILVR ION METAL BARIATRIC STANDARD FEATURES

- 1471-OB rated for 500 lbs.
- 1471-K rated for 1,000 lbs.
- 360° Clean-Thru Design
- Upholstered Seat and Back
- Wall-Saver Design
- Warm Grey (with Silver Ion Antimicrobial) Powder Coat on all Exposed Metal
- European Beech Arm Caps
- Non-Marring Adjustable Glides

BARIATRIC CHAIR

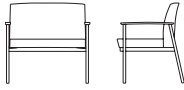

w	outside d	h	sw	seat sd	sh	seat to top of back	arm height	weight lbs.	cubic feet
34.5	26	33	30	18.5	19	14.25	25	72	26

model	yds com (54")	sq ft col	com 1	col 2	3	4	5	6	7	8	9	10	11	12	13	14	15	L1	L2	L3
1471-OB	2	n/a	1,342	1,375	1,413	1,460	1,525	1,619	1,713	1,808	1,902	1,996	2,090	2,184	2,278	2,372	2,466	1,760	1,855	1,948

BARIATRIC CHAIR



w	outside d	h	sw	seat sd	sh	seat to top of back	arm height	weight lbs.	cubic feet
34.5	26	33	30	18.5	19	14.25	25	72	26

model	yds com (54")	sq ft col	com 1	col 2	3	4	5	6	7	8	9	10	11	12	13	14	15	L1	L2	L3
1471-K	2	n/a	1,342	1,375	1,413	1,460	1,525	1,619	1,713	1,808	1,902	1,996	2,090	2,184	2,278	2,372	2,466	1,760	1,855	1,948

OPTIONS

Arm Caps	Powder Coat	Removable Covers	Fabric 1
Standard A3 Wood Arm Cap (specify finish)	Standard H1F Warm Grey	Standard X9 No Selection of Option	Selection Required
D1N Poly (black) D1M Poly (taupe) D1N Poly (grey)	See page 9 for full list of powder coat options NOTE: Any other powder coat specified will not have Silver Ion antimicrobial technology	H7 Removable Seat and Back Covers \$196 B1L Removable Seat Cover only \$98 B1M Removable Back Cover only \$98	Fabric: Grade, Vendor, Pattern, Color NOTE: For multiple fabric applications see page 14 for information and pricing

HOW TO ORDER

SPECIFY: Arm caps | arm cap finish (if applicable) | powder coat | removable covers | textile pattern and color. See pages 5-14 for information and options on moisture barrier, CAL133, upholstery applications, a complete offering of finishes and ordering details.

MODEL NUMBER

1471-OB

Arm Caps	Powder Coat	Removable Covers	Fabric 1
D1N	H1F	H7	Grade 5, Momentum, Row, Breeze

SILVR ION WOOD BARIATRIC STANDARD FEATURES

- 1441-OB rated for 500 lbs.
- 1441-K rated for 1,000 lbs.
- 360° Clean-Thru Design
- Upholstered Seat and Back
- Warm Grey (with Silver Ion Antimicrobial) Powder Coat on all Exposed Metal
- European Beech Arm Caps and Overlay on Legs
- Wall-Saver Design
- Non-Marring Adjustable Glides

BARIATRIC CHAIR

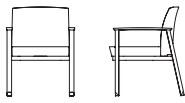

w	outside		h	sw	seat		sh	seat to top of back	arm height	weight lbs.	cubic feet
	d				sd						
34.5	26		33	30	18.5		19	14.25	25	72	26

model	yds com (54")	sq ft col	com 1	col 2	3	4	5	6	7	8	9	10	11	12	13	14	15	L1	L2	L3
1441-OB	2	n/a	1,758	1,791	1,829	1,876	1,941	2,035	2,129	2,224	2,318	2,412	2,506	2,600	2,694	2,788	2,882	2,176	2,271	2,364

BARIATRIC CHAIR



w	outside		h	sw	seat		sh	seat to top of back	arm height	weight lbs.	cubic feet
	d				sd						
34.5	26		33	30	18.5		19	14.25	25	72	26

model	yds com (54")	sq ft col	com 1	col 2	3	4	5	6	7	8	9	10	11	12	13	14	15	L1	L2	L3
1441-K	2	n/a	1,758	1,791	1,829	1,876	1,941	2,035	2,129	2,224	2,318	2,412	2,506	2,600	2,694	2,788	2,882	2,176	2,271	2,364

OPTIONS

Arm Caps	Finish	Powder Coat	Removable Covers	Arm Panels	Fabric 1
Standard A3 Wood Arm Cap	Selection Required	Standard HIF Warm Grey	Standard X9 No Selection of Option	Standard X9 No Selection of Option	Selection Required
D1N Poly (black) D1M Poly (taupe) D1N Poly (grey)	See page 9 for full list of finish options	See page 9 for full list of powder coat options NOTE: Any other powder coat specified will not have Silver Ion antimicrobial technology	H7 Removable Seat and Back Covers \$196 B1L Removable Seat Cover only \$98 B1M Removable Back Cover only \$98	WAP Pair of Wood (specify finish) \$418 UAP Pair of Upholstered (specify textile) (see pricing below)	Fabric: Grade, Vendor, Pattern, Color NOTE: For multiple fabric applications see page 14 for information and pricing

Arm Panel Options

yds com (54")	sq ft col	com 1	col 2	3	4	5	6	7	8	9	10	11	12	13	14	15	L1	L2	L3
0.75	n/a	529	541	555	573	598	633	668	704	739	774	809	845	880	915	950	703	739	774

HOW TO ORDER

SPECIFY: Arm caps | wood finish | powder coat | removable covers | arm panels | textile pattern and color. See pages 5-14 for information and options on moisture barrier, CAL133, upholstery applications, a complete offering of finishes and ordering details.

MODEL NUMBER

1441-OB

Arm Caps	Finish	Powder Coat	Removable Covers	Arm Panels	Fabric 1
D1N	MLC	HIF	H7	WAP - MHM	Grade 5, Momentum, Row, Breeze

VOYAGE BARIATRIC RECLINER STANDARD FEATURES

- Rated for 750 lbs.
- Durable Steel Recliner Mechanism
- Footrest and Back operate Independently of One Another
- Back can be Infinitely Positioned to any Sleep Position Angle
- Upholstered Seat and Back
- Upholstered Arms on 1507-OB
- Upholstered Arm Panels with European Beech Open Arm Frame on 1507WA-OB
- Tight Cushion
- Warm Grey (with Silver Ion Antimicrobial) Powder Coated Steel Foot Release Lever
- 5" Fixed Casters in Front, 5" Swivel Rear Casters with Brake

CLOSED ARM BARIATRIC RECLINER

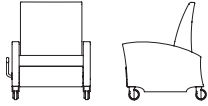

w	outside d	h	sw	seat sd	sh	seat to top of back	arm height	extended length	weight lbs.	cubic feet
39	37.5	45.25	29	21	21	24.25	27.5	72	153	50

model	yds com (54")	sq ft col	com 1	col 2	3	4	5	6	7	8	9	10	11	12	13	14	15	L1	L2	L3
1507-OB	6.5	n/a	3,706	3,813	3,935	4,088	4,302	4,608	4,913	5,219	5,525	5,830	6,136	6,442	6,747	7,053	7,359	5,001	5,309	5,612

OPEN ARM BARIATRIC RECLINER

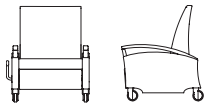

w	outside d	h	sw	seat sd	sh	seat to top of back	arm height	extended length	weight lbs.	cubic feet
39	37.5	45.25	29	21	21	24.25	27.5	72	153	50

model	yds com (54")	sq ft col	com 1	col 2	3	4	5	6	7	8	9	10	11	12	13	14	15	L1	L2	L3
1507WA-OB	6.5	n/a	4,147	4,254	4,376	4,529	4,743	5,049	5,354	5,660	5,966	6,271	6,577	6,883	7,188	7,494	7,800	5,442	5,750	6,053

OPTIONS

Arm Caps and Arm Rests	Finish (1507WA-OB only)	Attachments	Seat Back	Caster and Base	Removable Covers	Head Rest	Fabric 1
Standard X9 No Arm Cap	Selection Required	Standard X9 No Selection of Option	Standard X9 No Selection of Option	Standard X9 No Selection of Option	Standard X9 No Selection of Option	Standard X9 No Selection of Option	Selection Required
Black Poly Arm Caps H3S Left Side Facing \$155 H3T Right Side Facing \$155 A4 Pair \$309 Ergo Arm Rests (not available on 1507WA-OB) G1G Left Side Facing \$246 G1H Right Side Facing \$246 H3R Pair \$492	See page 9 for full list of finish options	K9 3DL Drop Table - Right Facing (specify color) \$183 DBH Hook \$93 NOTE: DBH Hook is field installed Heated Seat and Back H1C Standard power cord (not available on 1507WA-OB) \$313 H1D Fully retractable power cord (not available on 1507WA-OB) \$1,181	L2 Push Bar \$152 H1Z Padded Push Bar \$284 L4 Back Bump Guard \$183	CLC Central Locking Casters \$980 E1K Pull-Out Foot Tray \$246	H7 Removable Seat and Back Covers \$249 B1L Removable Seat Cover only \$125 B1M Removable Back Cover only \$125	G1F Head Pillow (attached with velcro for comfort and adjustability) (see pricing below)	Fabric: Grade, Vendor, Pattern, Color NOTE: For multiple fabric applications see page 14 for information and pricing

Head Rest Options

yds com (54")	sq ft col	com 1	col 2	3	4	5	6	7	8	9	10	11	12	13	14	15	L1	L2	L3
0.75	n/a	84	96	110	128	153	188	223	259	294	329	364	400	435	470	505	258	294	329

HOW TO ORDER

SPECIFY: Arm caps | wood finish (1507WA-OB only) | attachments | seat back | caster and base | removable covers | head rest | textile pattern and color. See pages 5-14 for information and options on moisture barrier, CAL133, upholstery applications, a complete offering of finishes and ordering details.

MODEL NUMBER

1507WA-OB

Arm Caps and Arm Rests	Finish (1507WA-OB only)	Attachments	Seat Back	Caster and Base	Removable Covers	Head Rest	Fabric 1
X9	MLC	K9	L2	CLC	H7	G1F	Grade 5, Momentum, Row, Breeze

VOYAGE BARIATRIC STANDARD FEATURES

- 1520-OB rated for 500 lbs.
- 1520-K rated for 1,000 lbs.
- Clean-Thru Design
- Field Replaceable Components
- Upholstered Seat and Back
- Wall-Saver Design
- European Beech Exterior Frame
- Non-Marring Adjustable Glides

BARIATRIC CHAIR

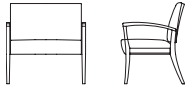

w	outside			sw	seat			seat to top of back							arm height	weight lbs.	cubic feet
	d	h			sd	sh											
33	26.5	34		30	19.5	17		17							25.5	55	28

model	yds com (54")	sq ft col	com 1	col 2	3	4	5	6	7	8	9	10	11	12	13	14	15	L1	L2	L3
1520-OB	2	n/a	1,303	1,336	1,374	1,421	1,486	1,580	1,674	1,769	1,863	1,957	2,051	2,145	2,239	2,333	2,427	1,721	1,816	1,909

BARIATRIC CHAIR

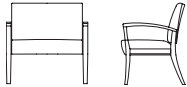

w	outside			sw	seat			seat to top of back							arm height	weight lbs.	cubic feet		
	d	h			sd	sh													
34	26.5	34		30	19.5	17		17									25.5	60	28

model	yds com (54")	sq ft col	com 1	col 2	3	4	5	6	7	8	9	10	11	12	13	14	15	L1	L2	L3
1520-K	2	n/a	1,417	1,450	1,488	1,535	1,600	1,694	1,788	1,883	1,977	2,071	2,165	2,259	2,353	2,447	2,541	1,835	1,930	2,023

OPTIONS

Arm Caps	Finish	Removable Covers	Fabric 1
Standard X9 No Arm Cap	Selection Required	Standard X9 No Selection of Option	Selection Required
A4 Poly (black) \$185 pair	See page 9 for full list of finish options	H7 Removable Seat and Back Covers \$196 B1L Removable Seat Cover only \$98 B1M Removable Back Cover only \$98	Fabric: Grade, Vendor, Pattern, Color NOTE: For multiple fabric applications see page 14 for information and pricing

HOW TO ORDER

SPECIFY: Arm caps | wood finish | removable covers | textile pattern and color. See pages 5-14 for information and options on moisture barrier, CAL133, upholstery applications, a complete offering of finishes and ordering details.

MODEL NUMBER

1520-OB

Arm Caps	Finish	Removable Covers	Fabric 1
X9	MLC	H7	Grade 5, Momentum, Row, Breeze

AMENITY THREE-POSITION CLOSED & OPEN ARM RECLINER STANDARD FEATURES

- Durable Steel Three-Position Recliner Mechanism
- Upholstered Arms with Maple Wood Legs on 1377
- Upholstered Seat and Back
- Tight Cushion
- Upholstered Arms with Maple Wood Legs on 1377
- Maple Exterior Frame with Open Arms on 1377-OA
- Trendelenburg Mechanism Activated via a Release Lever located on the Outside Back of the Recliner
- Non-Marring Adjustable Glides

THREE-POSITION CLOSED ARM RECLINER

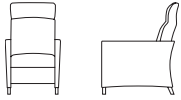

w	outside			sw	seat			seat to top of back	arm height	extended length	weight lbs.	cubic feet
	d	h			sd	sh						
26.5	34	43		21.5	20.5	18		29	25	68	90	38

model	yds com (54")	sq ft col	com 1	col 2	3	4	5	6	7	8	9	10	11	12	13	14	15	L1	L2	L3
1377	6.5	n/a	2,856	2,963	3,085	3,238	3,452	3,758	4,063	4,369	4,675	4,980	5,286	5,592	5,897	6,203	6,509	4,151	4,459	4,762

THREE-POSITION OPEN ARM RECLINER

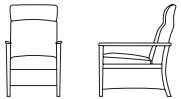

w	outside			sw	seat			seat to top of back	arm height	extended length	weight lbs.	cubic feet
	d	h			sd	sh						
26.5	34	43		21.5	20.5	18		29	25	68	90	38

model	yds com (54")	sq ft col	com 1	col 2	3	4	5	6	7	8	9	10	11	12	13	14	15	L1	L2	L3
1377-OA	4.5	n/a	2,688	2,762	2,847	2,953	3,101	3,312	3,524	3,735	3,947	4,159	4,370	4,582	4,793	5,005	5,217	3,593	3,807	4,016

OPTIONS

Arm Caps	Finish	Attachments	Seat Back	Caster	Mechanism	Fabric 1
Standard X9 No Arm Cap	Standard X9 No Selection of Option	Standard X9 No Selection of Option	Standard X9 No Selection of Option	Standard X9 No Selection of Option	Standard X9 No Selection of Option	Selection Required
A3 Wood (specify finish) (available on 1377) \$247 pair A4 Poly (black) \$309 pair	See page 9 for full list of finish options NOTE: Select finish when 1377-OA model or A3 wood arm cap option is specified	K9 3DL Drop Table - Right Facing (specify color) (available on 1377) \$183 DBH Hook \$93 NOTE: DBH Hook is field installed	L2 Push Bar \$152 L4 Back Bump Guard \$183	K8 Casters (set of 4) (front locking) (available on 1377) \$288	L3 Trendelenburg \$238	Fabric: Grade, Vendor, Pattern, Color NOTE: For multiple fabric applications see page 14 for information and pricing

HOW TO ORDER

SPECIFY: Arm caps | arm cap/wood finish (if applicable) | attachments | seat back | caster | mechanism | textile pattern and color. See pages 5-14 for information and options on moisture barrier, CAL133, upholstery applications, a complete offering of finishes and ordering details.

MODEL NUMBER

1377

Arm Caps	Finish	Attachments	Seat Back	Caster	Mechanism	Fabric 1
A3 - MLC	X9	K9 - LC3	L2	K8	L3	Grade 5, Momentum, Row, Breeze

AMENITY RECLINER STANDARD FEATURES

- Durable Steel Recliner Mechanism
- Footrest and Back operate Independently of One Another
- Back can be Infinitely Positioned to any Sleep Position Angle
- Upholstered Arms, Seat and Back
- Warm Grey (with Silver Ion Antimicrobial) Powder Coated Steel Foot Release Lever
- 4" Swivel Front Casters with Brake, 4" Fixed Rear
- 1614 rated for 750 lbs.

RECLINER

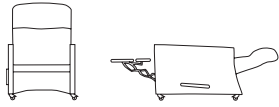

w	outside d	h	sw	seat sd	sh	seat to top of back	arm height	extended length	weight lbs.	cubic feet
31.5	39	44	24	21	21	30	25.5	72	130	38

model	yds com (54")	sq ft col	com 1	col 2	3	4	5	6	7	8	9	10	11	12	13	14	15	L1	L2	L3
1607	6.25	n/a	3,119	3,222	3,339	3,486	3,692	3,986	4,280	4,574	4,868	5,162	5,455	5,749	6,043	6,337	6,631	4,366	4,662	4,953

BARIATRIC RECLINER

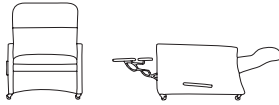

w	outside d	h	sw	seat sd	sh	seat to top of back	arm height	extended length	weight lbs.	cubic feet
38	38	48	28	21	20	33	27	76	150	50

model	yds com (54")	sq ft col	com 1	col 2	3	4	5	6	7	8	9	10	11	12	13	14	15	L1	L2	L3
1614	8.25	n/a	3,840	3,976	4,131	4,325	4,596	4,984	5,372	5,760	6,148	6,536	6,924	7,312	7,700	8,088	8,476	5,476	5,867	6,252

OPTIONS

Arm Caps	Attachments	Seat Back	Fabric 1
Standard X9 No Arm Cap	Standard X9 No Selection of Option	Standard X9 No Selection of Option	Selection Required
A3 Wood (specify finish) \$247 pair A4 Poly (black) \$309 pair	K9 3DL Drop Table - Right Facing (specify color) \$183 DBH Hook \$93 NOTE: DBH Hook is field installed	L2 Push Bar \$152 L4 Back Bump Guard \$183	Fabric: Grade, Vendor, Pattern, Color NOTE: For multiple fabric applications see page 14 for information and pricing

HOW TO ORDER

SPECIFY: Arm caps | arm cap finish (if applicable) | attachments | seat back | textile pattern and color. See pages 5-14 for information and options on moisture barrier, CAL133, upholstery applications, a complete offering of finishes and ordering details.

MODEL NUMBER

1607

Arm Caps	Attachments	Seat Back	Fabric 1
A3 - MLC	K9 - LC3	L2	Grade 5, Momentum, Row, Breeze

AMICO THREE-POSITION RECLINER STANDARD FEATURES

- Durable Steel Three-Position Recliner Mechanism
- Upholstered Arms, Seat and Back
- Tight Cushion
- Tapered European Beech Legs
- Non-Marring Adjustable Glides

THREE-POSITION RECLINER

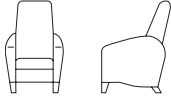

	outside			seat			seat to top	arm	extended	weight	cubic
	w	d	h	sw	sd	sh	of back	height	length	lbs.	feet
	28.5	35	42	21.5	20	20	27	27	62	102	38

model	yds com (54")	sq ft col	com 1	col 2	3	4	5	6	7	8	9	10	11	12	13	14	15	L1	L2	L3
1659-R	6.25	n/a	2,545	2,648	2,765	2,912	3,118	3,412	3,706	4,000	4,294	4,588	4,881	5,175	5,469	5,763	6,057	3,792	4,088	4,379

OPTIONS

Arm Caps	Finish	Attachments	Seat Back	Caster	Fabric 1
Standard X9 No Arm Cap	Selection Required	Standard X9 No Selection of Option	Standard X9 No Selection of Option	Standard X9 No Selection of Option	Selection Required
A3 Wood (specify finish) \$247 pair A4 Poly (black) \$309 pair	See page 9 for full list of finish options	K9 3DL Drop Table - Right Facing (specify color) \$183 DBH Hook \$93 NOTE: DBH Hook is field installed	L2 Push Bar \$152 L4 Back Bump Guard \$183	K8 Casters (set of 4) (front locking) \$288	Fabric: Grade, Vendor, Pattern, Color NOTE: For multiple fabric applications see page 14 for information and pricing

HOW TO ORDER

SPECIFY: Arm caps | wood finish (if applicable) | attachments | seat back | caster | mechanism | textile pattern and color. See pages 5-14 for information and options on moisture barrier, CAL133, upholstery applications, a complete offering of finishes and ordering details.

MODEL NUMBER

1659-R

Arm Caps	Finish	Attachments	Seat Back	Caster	Fabric 1
A4	MLC	K9 - LC3	L2	K8	Grade 5, Momentum, Row, Breeze

CORONADO THREE-POSITION RECLINER STANDARD FEATURES

- Durable Steel Three-Position Recliner Mechanism
- Upholstered Arms, Seat and Back
- Tight Cushion
- Tapered Maple Legs on 1707
- 4" Swivel Front Casters with Brake, 4" Fixed Rear
- Non-Marring Adjustable Glides

THREE-POSITION HIGH LEG RECLINER

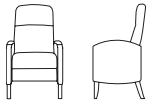

w	outside d	h	sw	seat sd	sh	seat to top of back	arm height	extended length	weight lbs.	cubic feet
26.5	36	43	21.5	21	20	28	24	65	102	38

model	yds com (54")	sq ft col	com 1	col 2	3	4	5	6	7	8	9	10	11	12	13	14	15	L1	L2	L3
1707	5.75	n/a	2,791	2,886	2,994	3,129	3,318	3,589	3,859	4,129	4,400	4,670	4,941	5,211	5,481	5,752	6,022	3,940	4,213	4,480

THREE-POSITION RECLINER WITH CASTERS

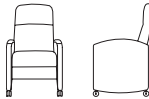

w	outside d	h	sw	seat sd	sh	seat to top of back	arm height	extended length	weight lbs.	cubic feet
26.5	36	43	21.5	21	20	28	24	65	96	38

model	yds com (54")	sq ft col	com 1	col 2	3	4	5	6	7	8	9	10	11	12	13	14	15	L1	L2	L3
1707C	5.75	n/a	2,703	2,798	2,906	3,041	3,230	3,501	3,771	4,041	4,312	4,582	4,853	5,123	5,393	5,664	5,934	3,852	4,125	4,392

CORONADO WALL-SAVER RECLINER STANDARD FEATURES

- Direct Drive Activation Synchronizes Right and Left Sides for Easy Opening
- Wall Clearance of 2.5"
- Upholstered Arms, Seat and Back
- Tight Cushion
- Non-Marring Adjustable Glides

WALL-SAVER RECLINER

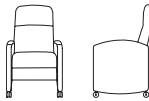

w	outside d	h	sw	seat sd	sh	seat to top of back	arm height	extended length	weight lbs.	cubic feet
27	36	42.5	22	21	21	23	26.5	65	88	38

model	yds com (54")	sq ft col	com 1	col 2	3	4	5	6	7	8	9	10	11	12	13	14	15	L1	L2	L3
1727	6.25	n/a	3,123	3,226	3,343	3,490	3,696	3,990	4,284	4,578	4,872	5,166	5,459	5,753	6,047	6,341	6,635	4,370	4,666	4,957

OPTIONS

Arm Caps	Finish	Attachments	Seat Back	Caster	Fabric 1
Standard X9 No Arm Cap	Standard X9 No Selection of Option	Standard X9 No Selection of Option	Standard X9 No Selection of Option	Standard X9 No Selection of Option	Selection Required
A3 Wood (specify finish) \$247 pair A4 Poly (black) \$309 pair	See page 9 for full list of finish options NOTE: Select finish when 1707 model or A3 wood arm cap option is specified	K9 3DL Drop Table - Right Facing (specify color) \$183 DBH Hook \$93 NOTE: DBH Hook is field installed	L2 Push Bar \$152 L4 Back Bump Guard \$183	K8 Casters (set of 4) (front locking) (available on 1727 only) \$288	Fabric: Grade, Vendor, Pattern, Color NOTE: For multiple fabric applications see page 14 for information and pricing

HOW TO ORDER

SPECIFY: Arm caps | arm cap/wood finish (if applicable) | attachments | seat back | caster | textile pattern and color. See pages 5-14 for information and options on moisture barrier, CAL133, upholstery applications, a complete offering of finishes and ordering details.

MODEL NUMBER					
1707					
Arm Caps	Finish	Attachments	Seat Back	Caster	Fabric 1
A3 - MLC	MLC	K9 - LC3	L2	K8	Grade 5, Momentum, Row, Breeze

CORONADO WALL-SAVER RECLINER STANDARD FEATURES

- Direct Drive Activation Synchronizes Right and Left Sides for Easy Opening
- Wall Clearance of 2.5"
- Upholstered Arms, Seat and Back
- Tight Cushion
- Non-Marring Adjustable Glides

WALL-SAVER RECLINER

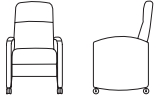

w	outside			sw	seat			seat to top of back	arm height	extended length	weight lbs.	cubic feet
	d	h			sd	sh						
27	36	42.5		22	21	21		23	26.5	65	88	38

model	yds com (54")	sq ft col	com 1	col 2	3	4	5	6	7	8	9	10	11	12	13	14	15	L1	L2	L3
1727	6.25	n/a	3,123	3,226	3,343	3,490	3,696	3,990	4,284	4,578	4,872	5,166	5,459	5,753	6,047	6,341	6,635	4,370	4,666	4,957

OPTIONS

Arm Caps	Finish	Attachments	Seat Back	Caster	Fabric 1
Standard X9 No Arm Cap	Standard X9 No Selection of Option	Standard X9 No Selection of Option	Standard X9 No Selection of Option	Standard X9 No Selection of Option	Selection Required
A3 Wood (specify finish) \$247 pair A4 Poly (black) \$309 pair	See page 9 for full list of finish options NOTE: Select finish when 1707 model or A3 wood arm cap option is specified	K9 3DL Drop Table - Right Facing (specify color) \$183 DBH Hook \$93 NOTE: DBH Hook is field installed	L2 Push Bar \$152 L4 Back Bump Guard \$183	K8 Casters (set of 4) (front locking) (available on 1727 only) \$288	Fabric: Grade, Vendor, Pattern, Color NOTE: For multiple fabric applications see page 14 for information and pricing

HOW TO ORDER

SPECIFY: Arm caps | arm cap/wood finish (if applicable) | attachments | seat back | caster | textile pattern and color. See pages 5-14 for information and options on moisture barrier, CAL133, upholstery applications, a complete offering of finishes and ordering details.

MODEL NUMBER

1707

Arm Caps	Finish	Attachments	Seat Back	Caster	Fabric 1
A3 - MLC	MLC	K9 - LC3	L2	K8	Grade 5, Momentum, Row, Breeze

MODERN AMENITY THREE-POSITION OPEN ARM RECLINER STANDARD FEATURES

- Durable Steel Three-Position Recliner Mechanism
- Upholstered Seat and Back
- Tight Cushion
- Must specify European Beech or American Ash Frame
- Open Arm Frame with Wood Arm Cap is Standard
- Wall-Saver Design
- Non-Marring Adjustable Glides
- NOTE: Because of the unique Color of Ash Hardwoods, Stains are a slightly different Color than they appear on the Standard European Beech Hardwoods. If pairing with a Product using Species other than Ash the Stains will appear different. For additional information please contact your Customer Service Representative.

OPEN ARM THREE-POSITION RECLINER

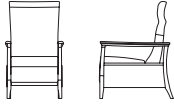

	outside			seat		seat to top	arm	extended	weight	cubic
w	d	h	sw	sd	sh	of back	height	length	lbs.	feet
26.5	33.25	44	21	20	19	25	25.25	68.5	87	36

model	yds com (54")	sq ft col	com 1	col 2	3	4	5	6	7	8	9	10	11	12	13	14	15	L1	L2	L3
1677-OA	4.25	n/a	2,482	2,552	2,632	2,732	2,872	3,072	3,271	3,471	3,671	3,871	4,071	4,271	4,470	4,670	4,870	3,339	3,540	3,738

OPTIONS

Wood Species	Arm Caps	Finish	Attachment	Seat Back	Fabric 1
Selection Required	Standard A3 Wood	Selection Required	Standard X9 No Selection of Option	Standard X9 No Selection of Option	Selection Required
A8S European Beech A8T American Ash	Poly \$210 pair DIN Black DIM Taupe DIP Grey Solid Surface \$615 pair CWS Cameo White MWS Modern White CSS Concrete DMS Deep Mink	See page 9 for full list of finish options	DBH Hook \$93 NOTE: DBH Hook is field installed	L4 Back Bump Guard \$183	Fabric: Grade, Vendor, Pattern, Color NOTE: For multiple fabric applications see page 14 for information and pricing

HOW TO ORDER

SPECIFY: Wood species | arm caps | wood finish | attachment | seat back | textile pattern and color. See pages 5-14 for information and options on moisture barrier, CAL133, upholstery applications, a complete offering of finishes and ordering details.

MODEL NUMBER

1677-OA

Wood Species	Arm Caps	Finish	Attachment	Seat Back	Fabric 1
A8T	A3	MLC	DBH	L4	Grade 5, Momentum, Row, Breeze

MODERN AMENITY THREE-POSITION CLOSED ARM RECLINER STANDARD FEATURES

- Durable Steel Three-Position Recliner Mechanism
- Upholstered Seat and Back
- Tight Cushion
- Must specify European Beech or American Ash
- Upholstered Arm Panel with No Arm Cap is Standard
- Wall-Saver Design
- Non-Marring Adjustable Glides
- NOTE: Because of the unique Color of Ash Hardwoods, Stains are a slightly different Color than they appear on the Standard European Beech Hardwoods. If pairing with a Product using Species other than Ash the Stains will appear different. For additional information please contact your Customer Service Representative.

CLOSED ARM THREE-POSITION RECLINER

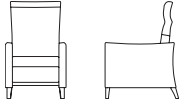

	outside			seat			seat to top	arm	extended	weight	cubic
	w	d	h	sw	sd	sh	of back	height	length	lbs.	feet
	26.5	33.25	44	21	20	19	25	25.25	68.5	87	36

model	yds com (54")	sq ft col	com 1	col 2	3	4	5	6	7	8	9	10	11	12	13	14	15	L1	L2	L3
1677	6	n/a	2,213	2,312	2,425	2,566	2,763	3,045	3,327	3,610	3,892	4,174	4,456	4,738	5,020	5,302	5,585	3,411	3,695	3,974

OPTIONS

Wood Species	Arm Caps	Finish	Attachments	Seat Back	Fabric 1
Selection Required	Standard X9 No Arm Cap	Selection Required	Standard X9 No Selection of Option	Standard X9 No Selection of Option	Selection Required
A8S European Beech A8T American Ash	A3 Wood (specify finish) Poly \$210 pair DIN Black DIM Taupe DIP Grey Solid Surface \$615 pair CWS Cameo White MWS Modern White CSS Concrete DMS Deep Mink	See page 9 for full list of finish options	K9 3DL Drop Table - Right Facing (specify color) \$183 DBH Hook \$93 NOTE: DBH Hook is field installed	L4 Back Bump Guard \$183	Fabric: Grade, Vendor, Pattern, Color NOTE: For multiple fabric applications see page 14 for information and pricing

HOW TO ORDER

SPECIFY: Wood species | arm caps | wood finish | attachments | seat back | textile pattern and color. See pages 5-14 for information and options on moisture barrier, CAL133, upholstery applications, a complete offering of finishes and ordering details.

MODEL NUMBER

1677

Wood Species	Arm Caps	Finish	Attachments	Seat Back	Fabric 1
A8T	A3	MLC	K9 - LC3	L4	Grade 5, Momentum, Row, Breeze

MODERN AMENITY THREE-POSITION CLOSED ARM RECLINER WITH CASTERS STANDARD FEATURES

- Durable Steel Three-Position Recliner Mechanism
- Upholstered Seat and Back
- Tight Cushion
- Upholstered Arm Panel without Arm Cap is Standard
- 4 - 5" Individual Locking Back Casters Standard (Black)
- NOTE: Because of the unique Color of Ash Hardwoods, Stains are a slightly different Color than they appear on the Standard European Beech Hardwoods. If pairing with a Product using Species other than Ash the Stains will appear different. For additional information please contact your Customer Service Representative.

CLOSED ARM THREE-POSITION W/ CASTERS

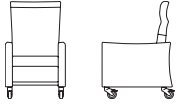

w	outside			sw	seat			seat to top of back	arm height	extended length	weight lbs.	cubic feet
	d	h			sd	sh						
26.5	33.25	44		21	20	19	25	25.25	68.5	87	36	

model	yds com (54")	sq ft col	com			col			1			2			3			4			5			6			7			8			9			10			11			12			13			14			15			L1			L2			L3		
			1	2	3	4	5	6	7	8	9	10	11	12	13	14	15	L1	L2	L3																																										
1677C	6	n/a	2,629	2,728	2,841	2,982	3,179	3,461	3,743	4,026	4,308	4,590	4,872	5,154	5,436	5,718	6,001	3,827	4,111	4,390																																										

OPTIONS

Wood Species	Arm Caps	Attachments	Seat Back	Fabric 1
Standard X9 No Selection of Option	Standard X9 No Arm Cap	Standard X9 No Selection of Option	Standard X9 No Selection of Option	Selection Required
A8S European Beech A8T American Ash NOTE: Select wood species when A3 wood arm cap option is specified	A3 Wood (specify finish) Poly \$210 pair DIN Black DIM Taupe DIP Grey Solid Surface \$615 pair CWS Cameo White MWS Modern White CSS Concrete DMS Deep Mink	K9 3DL Drop Table - Right Facing (specify color) \$183 DBH Hook \$93 NOTE: DBH Hook is field installed	L2 Push Bar \$152 H1Z Padded Push Bar \$284 L4 Back Bump Guard \$183	Fabric: Grade, Vendor, Pattern, Color NOTE: For multiple fabric applications see page 14 for information and pricing

HOW TO ORDER

SPECIFY: Wood species (if applicable) | arm caps | arm cap finish (if applicable) | attachments | seat back | textile pattern and color. See pages 5-14 for information and options on moisture barrier, CAL133, upholstery applications, a complete offering of finishes and ordering details.

MODEL NUMBER

1677C

Wood Species	Arm Caps	Attachments	Seat Back	Fabric 1
A8T	A3 - MNW	K9 - LC3	L2	Grade 5, Momentum, Row, Breeze

MODERN AMENITY RECLINER STANDARD FEATURES

- Durable Steel Recliner Mechanism
- Footrest and Back operate Independently of One Another
- Back can be Infinitely Positioned to any Sleep Position Angle
- Upholstered Arms, Seat and Back
- Tight Cushion
- Warm Grey (with Silver Ion Antimicrobial) Powder Coated Steel Release Lever
- NOTE: Because of the unique Color of Ash Hardwoods, Stains are a slightly different Color than they appear on the Standard European Beech Hardwoods. If pairing with a Product using Species other than Ash the Stains will appear different. For additional information please contact your Customer Service Representative.

RECLINER

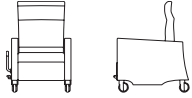

	outside			seat			seat to top	arm	extended	weight	cubic
	w	d	h	sw	sd	sh	of back	height	length	lbs.	feet
	34	39	48	24	20	20.25	30	28	72	145	50

model	yds com (54")	sq ft col	com 1	col 2	3	4	5	6	7	8	9	10	11	12	13	14	15	L1	L2	L3
1307	6	n/a	3,604	3,703	3,816	3,957	4,154	4,436	4,718	5,001	5,283	5,565	5,847	6,129	6,411	6,693	6,976	4,802	5,086	5,365

OPTIONS

Wood Species	Arm Caps	Arm	Attachments	Seat Back	Caster and Base	Removable Covers	Fabric 1
Standard X9 No Selection of Option	Standard X9 No Arm Cap	Standard X9 No Selection of Option	Standard X9 No Selection of Option	Standard X9 No Selection of Option	Standard X9 No Selection of Option	Standard X9 No Selection of Option	Selection Required
A8S European Beech A8T American Ash NOTE: Select wood species when A3 wood arm cap option is specified	A3 Wood (specify finish) \$163 pair Poly \$210 pair D1N Black D1M Taupe D1P Grey Solid Surface \$615 pair CWS Cameo White MWS Modern White CSS Concrete DMS Deep Mink	E1N Fold-Down (right side facing) \$570	K9 3DL Drop Table - Right Facing (specify color) (not available with fold-down arm option) \$183 DBH Hook \$93 NOTE: DBH Hook is field installed Heated Seat and Back H1C Standard power cord \$313 H1D Fully retractable power cord \$1,181	L2 Push Bar \$152 H1Z Padded Push Bar \$284 L4 Back Bump Guard \$183	Black Locking Casters CLC Central \$980 K8 Individual Black Locking Casters B9S Central \$980 B9R Individual White Locking Casters E1K Pull-Out Foot Tray \$246	B1L Removable Seat Cover only \$125	Fabric: Grade, Vendor, Pattern, Color NOTE: For multiple fabric applications see page 14 for information and pricing

HOW TO ORDER

SPECIFY: Wood species (if applicable) | arm caps | arm cap finish (if applicable) | arm | attachments | seat back | caster and base | removable cover | textile pattern and color. See pages 5-14 for information and options on moisture barrier, CAL133, upholstery applications, a complete offering of finishes and ordering details.

MODEL NUMBER

1307

Wood Species	Arm Caps	Arm	Attachments	Seat Back	Caster and Base	Removable Covers	Fabric 1
X9	D1N	E1N	K9 - LC3	L2	CLC	B1L	Grade 5, Momentum, Row, Breeze

MODERN AMENITY LITE RECLINER STANDARD FEATURES

- Durable Steel Recliner Mechanism
- Footrest and Back operate Independently of One Another
- Back can be Infinitely Positioned to any Sleep Position Angle
- Upholstered Arms, Seat and Back
- Tight Cushion
- Warm Grey (with Silver Ion Antimicrobial) Powder Coated Steel Release Lever
- NOTE: Because of the unique Color of Ash Hardwoods, Stains are a slightly different Color than they appear on the Standard European Beech Hardwoods. If pairing with a Product using Species other than Ash the Stains will appear different. For additional information please contact your Customer Service Representative.

LITE RECLINER

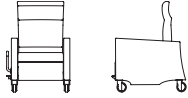

	outside			seat			seat to top	arm	extended	weight	cubic
	w	d	h	sw	sd	sh	of back	height	length	lbs.	feet
	32	39	48	22	20	20.25	27.75	28	72	145	38

model	yds com (54")	sq ft col	com 1	col 2	3	4	5	6	7	8	9	10	11	12	13	14	15	L1	L2	L3
1307-SR	6	n/a	3,116	3,215	3,328	3,469	3,666	3,948	4,230	4,513	4,795	5,077	5,359	5,641	5,923	6,205	6,488	4,314	4,598	4,877

OPTIONS

Wood Species	Arm Caps	Arm	Attachments	Seat Back	Caster and Base	Removable Covers	Fabric 1
Standard X9 No Selection of Option	Standard X9 No Arm Cap	Standard X9 No Selection of Option	Standard X9 No Selection of Option	Standard X9 No Selection of Option	Standard X9 No Selection of Option	Standard X9 No Selection of Option	Selection Required
A8S European Beech A8T American Ash NOTE: Select wood species when A3 wood arm cap option is specified	A3 Wood (specify finish) \$163 pair Poly \$210 pair D1N Black D1M Taupe D1P Grey Solid Surface \$615 pair CWS Cameo White MWS Modern White CSS Concrete DMS Deep Mink	E1N Fold-Down (right side facing) \$570	K9 3DL Drop Table - Right Facing (specify color) (not available with fold-down arm option) \$183 DBH Hook \$93 NOTE: DBH Hook is field installed Heated Seat and Back H1C Standard power cord \$313 H1D Fully retractable power cord \$1,181	L2 Push Bar \$152 H1Z Padded Push Bar \$284 L4 Back Bump Guard \$183	Black Locking Casters CLC Central \$980 K8 Individual Black Locking Casters B9S Central \$980 B9R Individual White Locking Casters E1K Pull-Out Foot Tray \$246	B1L Removable Seat Cover only \$125	Fabric: Grade, Vendor, Pattern, Color NOTE: For multiple fabric applications see page 14 for information and pricing

HOW TO ORDER

SPECIFY: Wood species (if applicable) | arm caps | arm cap finish (if applicable) | arm | attachments | seat back | caster and base | removable cover | textile pattern and color. See pages 5-14 for information and options on moisture barrier, CAL133, upholstery applications, a complete offering of finishes and ordering details.

MODEL NUMBER

1307-SR

Wood Species	Arm Caps	Arm	Attachments	Seat Back	Caster and Base	Removable Covers	Fabric 1
X9	D1N	E1N	K9 - LC3	L2	CLC	B1L	Grade 5, Momentum, Row, Breeze

MODERN AMENITY BARIATRIC RECLINER STANDARD FEATURES

- Rated for 750 lbs.
- Upholstered Arms, Seat and Back
- Durable Steel Recliner Mechanism
- Tight Cushion
- Footrest and Back operate Independently of One Another
- Warm Grey (with Silver Ion Antimicrobial) Powder Coated Steel Release Lever
- Back can be Infinitely Positioned to any Sleep Position Angle
- NOTE: Because of the unique Color of Ash Hardwoods, Stains are a slightly different Color than they appear on the Standard European Beech Hardwoods. If pairing with a Product using Species other than Ash the Stains will appear different. For additional information please contact your Customer Service Representative.

BARIATRIC RECLINER

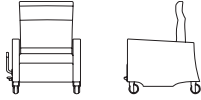

	outside			seat			seat to top	arm	extended	weight	cubic
	w	d	h	sw	sd	sh	of back	height	length	lbs.	feet
	39	39	48	29	20	20.25	30	28	72	155	50

model	yds com (54")	sq ft col	com 1	col 2	3	4	5	6	7	8	9	10	11	12	13	14	15	L1	L2	L3
1307-OB	6.5	n/a	3,789	3,896	4,018	4,171	4,385	4,691	4,996	5,302	5,608	5,913	6,219	6,525	6,830	7,136	7,442	5,084	5,392	5,695

OPTIONS

Wood Species	Arm Caps	Attachments	Seat Back	Caster and Base	Removable Covers	Fabric 1
Standard X9 No Selection of Option	Standard X9 No Arm Cap	Standard X9 No Selection of Option	Standard X9 No Selection of Option	Standard X9 No Selection of Option	Standard X9 No Selection of Option	Selection Required
A8S European Beech A8T American Ash NOTE: Select wood species when A3 wood arm cap option is specified	A3 Wood (specify finish) \$163 pair Poly \$210 pair D1N Black D1M Taupe D1P Grey Solid Surface \$615 pair CWS Cameo White MWS Modern White CSS Concrete DMS Deep Mink	K9 3DL Drop Table - Right Facing (specify color) (not available with fold-down arm option) \$183 DBH Hook \$93 NOTE: DBH Hook is field installed Heated Seat and Back H1C Standard power cord \$313 H1D Fully retractable power cord \$1,181	L2 Push Bar \$152 H1Z Padded Push Bar \$284 L4 Back Bump Guard \$183	Black Locking Casters CLC Central \$980 K8 Individual Black Locking Casters B9S Central \$980 B9R Individual White Locking Casters E1K Pull-Out Foot Tray \$246	B1L Removable Seat Cover only \$125	Fabric: Grade, Vendor, Pattern, Color NOTE: For multiple fabric applications see page 14 for information and pricing

HOW TO ORDER

SPECIFY: Wood species (if applicable) | arm caps | arm cap finish (if applicable) | attachments | seat back | caster and base | removable cover | textile pattern and color. See pages 5-14 for information and options on moisture barrier, CAL133, upholstery applications, a complete offering of finishes and ordering details.

MODEL NUMBER

1307-OB

Wood Species	Arm Caps	Attachments	Seat Back	Caster and Base	Removable Covers	Fabric 1
X9	D1N	K9 - LC3	L2	CLC	B1L	Grade 5, Momentum, Row, Breeze

MODERN AMENITY RECLINER WITH TRENDELENBURG STANDARD FEATURES

- Painted Heavy Gauge Stamped Steel Lay Flat Recliner Mechanism with Heavy Steel Trendelenburg Release
- Footrest and Back operate Independently of One Another
- Back can be Infinitely Positioned to any Sleep Position Angle
- Upholstered Arms, Seat and Back
- Tight Cushion
- Warm Grey (with Silver Ion Antimicrobial) Powder Coated Steel Release Lever
- NOTE: Because of the unique Color of Ash Hardwoods, Stains are a slightly different Color than they appear on the Standard European Beech Hardwoods. If pairing with a Product using Species other than Ash the Stains will appear different. For additional information please contact your Customer Service Representative.

RECLINER WITH TRENDELENBURG

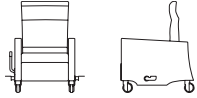

	outside			seat			seat to top	arm	extended	weight	cubic
	w	d	h	sw	sd	sh	of back	height	length	lbs.	feet
	40.75	39	48	24	20	20.25	30	28	72	168	50

model	yds com (54")	sq ft col	com 1	col 2	3	4	5	6	7	8	9	10	11	12	13	14	15	L1	L2	L3
1317	6	n/a	4,062	4,161	4,274	4,415	4,612	4,894	5,176	5,459	5,741	6,023	6,305	6,587	6,869	7,151	7,434	5,260	5,544	5,823

OPTIONS

Wood Species	Arm Caps	Arm	Attachments	Seat Back	Caster and Base	Removable Covers	Fabric 1
Standard X9 No Selection of Option	Standard X9 No Arm Cap	Standard X9 No Selection of Option	Standard X9 No Selection of Option	Standard X9 No Selection of Option	Standard X9 No Selection of Option	Standard X9 No Selection of Option	Selection Required
A8S European Beech A8T American Ash NOTE: Select wood species when A3 wood arm cap option is specified	A3 Wood (specify finish) \$163 pair Poly \$210 pair D1N Black D1M Taupe D1P Grey Solid Surface \$615 pair CWS Cameo White MWS Modern White CSS Concrete DMS Deep Mink	E1N Fold-Down (right side facing) \$570	K9 3DL Drop Table - Right Facing (specify color) (not available with fold-down arm option) \$183 DBH Hook \$93 NOTE: DBH Hook is field installed Heated Seat and Back H1C Standard power cord \$313 H1D Fully retractable power cord \$1,181	L2 Push Bar \$152 H1Z Padded Push Bar \$284 L4 Back Bump Guard \$183	Black Locking Casters CLC Central \$980 K8 Individual Black Locking Casters B9S Central \$980 B9R Individual White Locking Casters E1K Pull-Out Foot Tray \$246	B1L Removable Seat Cover only \$125	Fabric: Grade, Vendor, Pattern, Color NOTE: For multiple fabric applications see page 14 for information and pricing

HOW TO ORDER

SPECIFY: Wood species (if applicable) | arm caps | arm cap finish (if applicable) | arm | attachments | seat back | caster and base | removable cover | textile pattern and color. See pages 5-14 for information and options on moisture barrier, CAL133, upholstery applications, a complete offering of finishes and ordering details.

MODEL NUMBER

1317

Wood Species	Arm Caps	Arm	Attachments	Seat Back	Caster and Base	Removable Covers	Fabric 1
X9	D1N	E1N	K9 - LC3	L2	CLC	B1L	Grade 5, Momentum, Row, Breeze

ORCHESTRA RECLINER STANDARD FEATURES

- Durable Steel Recliner Mechanism
- Footrest and Back operate Independently of One Another
- Back can be Infinitely Positioned to any Sleep Position Angle
- Upholstered Arms, Seat and Back
- Tight Cushion
- Warm Grey (with Silver Ion Antimicrobial) Powder Coated Steel Foot Release Lever
- 5" Fixed Casters in Front, 5" Swivel Rear Casters with Brake

RECLINER

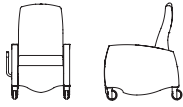

w	outside d	h	sw	seat sd	sh	seat to top of back	arm height	extended length	weight lbs.	cubic feet
34	36	47	24	20	20.25	28.5	28	75	135	38

model	yds com (54")	sq ft col	com 1	col 2	3	4	5	6	7	8	9	10	11	12	13	14	15	L1	L2	L3
1408-R	6.5	n/a	3,400	3,507	3,629	3,782	3,996	4,302	4,607	4,913	5,219	5,524	5,830	6,136	6,441	6,747	7,053	4,695	5,003	5,306

OPTIONS

Arm Caps and Arm Rests	Arm	Attachments	Seat Back	Caster and Base	Removable Covers	Head Rest	Fabric 1
Standard X9 No Arm Cap	Standard X9 No Selection of Option	Standard X9 No Selection of Option	Standard X9 No Selection of Option	Standard X9 No Selection of Option	Standard X9 No Selection of Option	Standard X9 No Selection of Option	Selection Required
Arm Caps A3 Wood (specify finish) \$247 pair Black Poly Arm Caps H3S Left Side Facing \$155 H3T Right Side Facing \$155 A4 Pair \$309 Ergo Arm Rests G1G Left Side Facing \$246 G1H Right Side Facing \$246 H3R Pair \$492	E1N Fold-Down (right side facing) \$570 NOTE: E1N option not available with G1H or H3R Ergo Arm Rests	K9 3DL Drop Table - Right Facing (specify color) (not available with fold-down arm option) \$183 DBH Hook \$93 NOTE: DBH Hook is field installed Heated Seat and Back H1C Standard power cord \$313 H1D Fully retractable power cord \$1,181	L2 Push Bar \$152 H1Z Padded Push Bar \$284 L4 Back Bump Guard \$183	CLC Central Locking Casters \$980 E1K Pull-Out Foot Tray \$246	H7 Removable Seat and Back Covers (back cover not available with adjustable head rest) \$249 B1L Removable Seat Cover only \$125 B1M Removable Back Cover only (back cover not available with adjustable head rest) \$125	G1F Head Pillow (attached with velcro for comfort and adjustability) (see pricing below) FIW Single Adjustable Head Rest (see pricing below) FIX Double Adjustable Head Rest (see pricing below)	Fabric: Grade, Vendor, Pattern, Color NOTE: For multiple fabric applications see page 14 for information and pricing

Head Rest Options G1F

yds com (54")	sq ft col	com 1	col 2	3	4	5	6	7	8	9	10	11	12	13	14	15	L1	L2	L3
0.75	n/a	85	97	111	129	154	189	224	260	295	330	365	401	436	471	506	259	295	330

Head Rest Options FIW

yds com (54")	sq ft col	com 1	col 2	3	4	5	6	7	8	9	10	11	12	13	14	15	L1	L2	L3
0.75	n/a	614	626	640	658	683	718	753	789	824	859	894	930	965	1,000	1,035	788	824	859

Head Rest Options FIX

yds com (54")	sq ft col	com 1	col 2	3	4	5	6	7	8	9	10	11	12	13	14	15	L1	L2	L3
0.75	n/a	1,114	1,126	1,140	1,158	1,183	1,218	1,253	1,289	1,324	1,359	1,394	1,430	1,465	1,500	1,535	1,288	1,324	1,359

HOW TO ORDER

SPECIFY: Arm caps and arm rests | arm cap finish (if applicable) | arm | attachments | seat back | caster and base | removable covers | head rest | textile pattern and color. See pages 5-14 for information and options on moisture barrier, CAL133, upholstery applications, a complete offering of finishes and ordering details.

MODEL NUMBER

1408-R

Arm Caps and Arm Rests	Arm	Attachments	Seat Back	Caster and Base	Removable Covers	Head Rest	Fabric 1
A3 - MLC	E1N	K9 - LC3	L2	CLC	H7	G1F	Grade 5, Momentum, Row, Breeze

ORCHESTRA LITE RECLINER STANDARD FEATURES

- Durable Steel Recliner Mechanism
- Footrest and Back operate Independently of One Another
- Back can be Infinitely Positioned to any Sleep Position Angle
- Upholstered Arms, Seat and Back
- Tight Cushion
- Warm Grey (with Silver Ion Antimicrobial) Powder Coated Steel Foot Release Lever
- 5" Fixed Casters in Front, 5" Swivel Rear Casters with Brake

LITE RECLINER

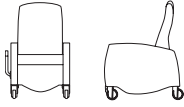

w	outside d	h	sw	seat sd	sh	seat to top of back	arm height	extended length	weight lbs.	cubic feet
32	36	46	22	20	20.25	27.5	28	75	135	38

model	yds com (54")	sq ft col	com 1	col 2	3	4	5	6	7	8	9	10	11	12	13	14	15	L1	L2	L3
1408-SR	6	n/a	3,228	3,327	3,440	3,581	3,778	4,060	4,342	4,625	4,907	5,189	5,471	5,753	6,035	6,317	6,600	4,426	4,710	4,989

OPTIONS

Arm Caps and Arm Rests	Arm	Attachments	Seat Back	Caster and Base	Removable Covers	Head Rest	Fabric 1
Standard X9 No Arm Cap	Standard X9 No Selection of Option	Standard X9 No Selection of Option	Standard X9 No Selection of Option	Standard X9 No Selection of Option	Standard X9 No Selection of Option	Standard X9 No Selection of Option	Selection Required
Arm Caps A3 Wood (specify finish) \$247 pair Black Poly Arm Caps H3S Left Side Facing \$155 H3T Right Side Facing \$155 A4 Pair \$309 Ergo Arm Rests G1G Left Side Facing \$246 G1H Right Side Facing \$246 H3R Pair \$492	E1N Fold-Down (right side facing) \$570 NOTE: E1N option not available with G1H or H3R Ergo Arm Rests	K9 3DL Drop Table - Right Facing (specify color) (not available with fold-down arm option) \$183 DBH Hook \$93 NOTE: DBH Hook is field installed Heated Seat and Back H1C Standard power cord \$313 H1D Fully retractable power cord \$1,181	L2 Push Bar \$152 L4 Back Bump Guard \$183	CLC Central Locking Casters \$980 E1K Pull-Out Foot Tray \$246	H7 Removable Seat and Back Covers \$249 B1L Removable Seat Cover only \$125 B1M Removable Back Cover only \$125	G1F Head Pillow (attached with velcro for comfort and adjustability) (see pricing below)	Fabric: Grade, Vendor, Pattern, Color NOTE: For multiple fabric applications see page 14 for information and pricing

Head Rest Options

yds com (54")	sq ft col	com 1	col 2	3	4	5	6	7	8	9	10	11	12	13	14	15	L1	L2	L3
0.75	n/a	85	97	111	129	154	189	224	260	295	330	365	401	436	471	506	259	295	330

HOW TO ORDER

SPECIFY: Arm caps and arm rests | arm cap finish (if applicable) | arm | attachments | seat back | caster and base | removable covers | head rest | textile pattern and color. See pages 5-14 for information and options on moisture barrier, CAL133, upholstery applications, a complete offering of finishes and ordering details.

MODEL NUMBER

1408-SR

Arm Caps and Arm Rests	Arm	Attachments	Seat Back	Caster and Base	Removable Covers	Head Rest	Fabric 1
A3 - MLC	E1N	K9 - LC3	L2	CLC	H7	G1F	Grade 5, Momentum, Row, Breeze

ORCHESTRA BARIATRIC RECLINER STANDARD FEATURES

- Rated for 750 lbs.
- Durable Steel Recliner Mechanism
- Footrest and Back operate Independently of One Another
- Back can be Infinitely Positioned to any Sleep Position Angle
- Upholstered Arms, Seat and Back
- Warm Grey (with Silver Ion Antimicrobial) Powder Coated Steel Foot Release Lever
- 5" Fixed Casters in Front, 5" Swivel Rear Casters with Brake

BARIATRIC RECLINER

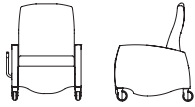

w	outside d	h	sw	seat sd	sh	seat to top of back	arm height	extended length	weight lbs.	cubic feet
36	36	47	29	20	20.25	28.5	28	75	155	50

model	yds com (54")	sq ft col	com 1	col 2	3	4	5	6	7	8	9	10	11	12	13	14	15	L1	L2	L3
1408-R-OB	7	n/a	4,221	4,336	4,468	4,632	4,863	5,192	5,521	5,850	6,180	6,509	6,838	7,167	7,496	7,825	8,154	5,614	5,946	6,271

OPTIONS

Arm Caps and Arm Rests	Attachments	Seat Back	Caster and Base	Removable Covers	Head Rest	Fabric 1
Standard X9 No Arm Cap	Standard X9 No Selection of Option	Standard X9 No Selection of Option	Standard X9 No Selection of Option	Standard X9 No Selection of Option	Standard X9 No Selection of Option	Selection Required
Arm Caps A3 Wood (specify finish) \$247 pair Black Poly Arm Caps H3S Left Side Facing \$155 H3T Right Side Facing \$155 A4 Pair \$309 Ergo Arm Rests G1G Left Side Facing \$246 G1H Right Side Facing \$246 H3R Pair \$492	K9 3DL Drop Table - Right Facing (specify color) (not available with fold-down arm option) \$183 DBH Hook \$93 NOTE: DBH Hook is field installed Heated Seat and Back H1C Standard power cord \$313 H1D Fully retractable power cord \$1,181	L2 Push Bar \$152 H1Z Padded Push Bar \$284 L4 Back Bump Guard \$183	CLC Central Locking Casters \$980 E1K Pull-Out Foot Tray \$246	H7 Removable Seat and Back Covers \$249 B1L Removable Seat Cover only \$125 B1M Removable Back Cover only \$125	G1F Head Pillow (attached with velcro for comfort and adjustability) (see pricing below)	Fabric: Grade, Vendor, Pattern, Color NOTE: For multiple fabric applications see page 14 for information and pricing

Head Rest Options

yds com (54")	sq ft col	com 1	col 2	3	4	5	6	7	8	9	10	11	12	13	14	15	L1	L2	L3
0.75	n/a	85	97	111	129	154	189	224	260	295	330	365	401	436	471	506	259	295	330

HOW TO ORDER

SPECIFY: Arm caps and arm rests | arm cap finish (if applicable) | attachments | seat back | caster and base | removable covers | head rest | textile pattern and color. See pages 5-14 for information and options on moisture barrier, CAL133, upholstery applications, a complete offering of finishes and ordering details.

MODEL NUMBER

1408-R-OB

Arm Caps and Arm Rests	Attachments	Seat Back	Caster and Base	Removable Covers	Head Rest	Fabric 1
A3 - MLC	K9 - LC3	L2	CLC	H7	G1F	Grade 5, Momentum, Row, Breeze

ORCHESTRA RECLINER WITH TRENDELENBURG STANDARD FEATURES

- Painted Heavy Gauge Stamped Steel Lay Flat Recliner Mechanism with Heavy Steel Trendelenburg Release
- Trendelenburg Mechanism Activated via a Release Lever located at the Bottom of the Left and Right Arm Panels
- Footrest and Back operate Independently of One Another
- Back can be Infinitely Positioned to any Sleep Position Angle
- Upholstered Arms, Seat and Back
- Tight Cushion
- Warm Grey (with Silver Ion Antimicrobial) Powder Coated Steel Foot Release Lever
- 5" Fixed Casters in Front, 5" Swivel Rear Casters with Brake

RECLINER WITH TRENDELENBURG

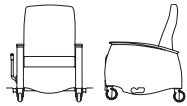

w	outside d	h	sw	seat sd	sh	seat to top of back	arm height	extended length	weight lbs.	cubic feet
39	36	47	24	20	20.25	28.5	28	75	200	50

model	yds com (54")	sq ft col	com 1	col 2	3	4	5	6	7	8	9	10	11	12	13	14	15	L1	L2	L3
1417	7	n/a	4,596	4,711	4,843	5,007	5,238	5,567	5,896	6,225	6,555	6,884	7,213	7,542	7,871	8,200	8,529	5,989	6,321	6,646

OPTIONS

Arm Caps and Arm Rests	Arm	Attachments	Seat Back	Caster and Base	Removable Covers	Head Rest	Fabric 1
Standard X9 No Arm Cap	Standard X9 No Selection of Option	Standard X9 No Selection of Option	Standard X9 No Selection of Option	Standard X9 No Selection of Option	Standard X9 No Selection of Option	Standard X9 No Selection of Option	Selection Required
Arm Caps A3 Wood (specify finish) \$247 pair H35 Left Side Facing \$155 H37 Right Side Facing \$155 A4 Pair \$309 Ergo Arm Rests G1G Left Side Facing \$246 G1H Right Side Facing \$246 H3R Pair \$492	E1N Fold-Down (right side facing) \$570 NOTE: E1N option not available with G1H or H3R Ergo Arm Rests	K9 3DL Drop Table - Right Facing (specify color) (not available with fold-down arm option) \$183 DBH Hook \$93 NOTE: DBH Hook is field installed Heated Seat and Back H1C Standard power cord \$313 H1D Fully retractable power cord \$1,181	L2 Push Bar \$152 H1Z Padded Push Bar \$284 L4 Back Bump Guard \$183	CLC Central Locking Casters \$980 E1K Pull-Out Foot Tray \$246	H7 Removable Seat and Back Covers (back cover not available with adjustable head rest) \$249 B1L Removable Seat Cover only \$125 B1M Removable Back Cover only (back cover not available with adjustable head rest) \$125	G1F Head Pillow (attached with velcro for comfort and adjustability) (see pricing below) FIW Single Adjustable Head Rest (see pricing below) FIX Double Adjustable Head Rest (see pricing below)	Fabric: Grade, Vendor, Pattern, Color NOTE: For multiple fabric applications see page 14 for information and pricing

Head Rest Options G1F

yds com (54")	sq ft col	com 1	col 2	3	4	5	6	7	8	9	10	11	12	13	14	15	L1	L2	L3
0.75	n/a	85	97	111	129	154	189	224	260	295	330	365	401	436	471	506	259	295	330

Head Rest Options FIW

yds com (54")	sq ft col	com 1	col 2	3	4	5	6	7	8	9	10	11	12	13	14	15	L1	L2	L3
0.75	n/a	614	626	640	658	683	718	753	789	824	859	894	930	965	1,000	1,035	788	824	859

Head Rest Options FIX

yds com (54")	sq ft col	com 1	col 2	3	4	5	6	7	8	9	10	11	12	13	14	15	L1	L2	L3
0.75	n/a	1,114	1,126	1,140	1,158	1,183	1,218	1,253	1,289	1,324	1,359	1,394	1,430	1,465	1,500	1,535	1,288	1,324	1,359

HOW TO ORDER

SPECIFY: Arm caps and arm rests | arm cap finish (if applicable) | arm | attachments | seat back | caster and base | removable covers | head rest | textile pattern and color. See pages 5-14 for information and options on moisture barrier, CAL133, upholstery applications, a complete offering of finishes and ordering details.

MODEL NUMBER

1417

Arm Caps and Arm Rests	Arm	Attachments	Seat Back	Caster and Base	Removable Covers	Head Rest	Fabric 1
A3 - MLC	E1N	K9 - LC3	L2	CLC	H7	G1F	Grade 5, Momentum, Row, Breeze

ORCHESTRA WINGBACK RECLINER STANDARD FEATURES

- Durable Steel Recliner Mechanism
- Upholstered Arms, Seat and Back
- 5" Fixed Casters in Front, 5" Swivel Rear Casters with Brake
- Footrest and Back operate Independently of One Another
- Tight Cushion
- Warm Grey (with Silver Ion Antimicrobial) Powder Coated Steel Foot Release Lever
- 1408-W-OB rated for 750 lbs.
- Back can be Infinitely Positioned to any Sleep Position Angle

WINGBACK RECLINER

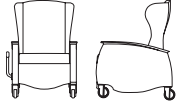

w	outside			sw	seat			seat to top of back	arm height	extended length	weight lbs.	cubic feet
	d	h			sd	sh						
34	36	47		24	20	20.25		28.5	28	75	135	38

model	yds com (54")	sq ft col	com 1	col 2	3	4	5	6	7	8	9	10	11	12	13	14	15	L1	L2	L3
1408-W	7	n/a	4,316	4,431	4,563	4,727	4,958	5,287	5,616	5,945	6,275	6,604	6,933	7,262	7,591	7,920	8,249	5,709	6,041	6,366

WINGBACK BARIATRIC RECLINER

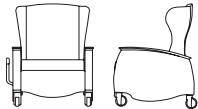

w	outside			sw	seat			seat to top of back	arm height	extended length	weight lbs.	cubic feet
	d	h			sd	sh						
36	36	47		29	20	20.25		28.5	28	75	155	50

model	yds com (54")	sq ft col	com 1	col 2	3	4	5	6	7	8	9	10	11	12	13	14	15	L1	L2	L3
1408-W-OB	7.5	n/a	4,669	4,792	4,934	5,110	5,357	5,709	6,062	6,415	6,767	7,120	7,473	7,825	8,178	8,531	8,883	6,159	6,515	6,864

OPTIONS

Arm Caps and Arm Rests	Arm	Attachments	Seat Back	Caster and Base	Removable Covers	Head Rest	Fabric 1
Standard X9 No Arm Cap	Standard X9 No Selection of Option	Standard X9 No Selection of Option	Standard X9 No Selection of Option	Standard X9 No Selection of Option	Standard X9 No Selection of Option	Standard X9 No Selection of Option	Selection Required
A3 Wood (specify finish) \$247 pair H3S Left Side Facing \$155 H3T Right Side Facing \$155 A4 Pair \$309 Ergo Arm Rests G1G Left Side Facing \$246 G1H Right Side Facing \$246 H3R Pair \$492	E1N Fold-Down (right side facing) (not available on 1408-W-OB) \$570 NOTE: E1N option not available with G1H or H3R Ergo Arm Rests	K9 3DL Drop Table - Right Facing (specify color) (not available with fold-down arm option) \$183 DBH Hook \$93 NOTE: DBH Hook is field installed Heated Seat and Back H1C Standard power cord (not available on 1408-W-OB) \$313 H1D Fully retractable power cord (not available on 1408-W-OB) \$1,181	L2 Push Bar \$152 H1Z Padded Push Bar \$284 L4 Back Bump Guard \$183	CLC Central Locking Casters \$980 E1K Pull-Out Foot Tray \$246	B1L Removable Seat Cover only \$125	G1F Head Pillow (attached with velcro for comfort and adjustability) (see pricing below)	Fabric: Grade, Vendor, Pattern, Color NOTE: For multiple fabric applications see page 14 for information and pricing

Head Rest Options	yds com (54")	sq ft col	com 1	col 2	3	4	5	6	7	8	9	10	11	12	13	14	15	L1	L2	L3
0.75	n/a	85	97	111	129	154	189	224	260	295	330	365	401	436	471	506	259	295	330	

HOW TO ORDER

SPECIFY: Arm caps and arm rests | arm cap finish (if applicable) | arm | attachments | seat back | caster and base | removable covers | head rest | textile pattern and color. See pages 5-14 for information and options on moisture barrier, CAL133, upholstery applications, a complete offering of finishes and ordering details.

MODEL NUMBER

1408-W

Arm Caps and Arm Rests	Arm	Attachments	Seat Back	Caster and Base	Removable Covers	Head Rest	Fabric 1
A3 - MLC	E1N	K9 - LC3	L2	CLC	B1L	G1F	Grade 5, Momentum, Row, Breeze

ORCHESTRA WINGBACK RECLINER WITH TRENDELENBURG STANDARD FEATURES

- Painted Heavy Gauge Stamped Steel Lay Flat Recliner Mechanism with Heavy Steel Trendelenburg Release
- Trendelenburg Mechanism Activated via a Release Lever located at the Bottom of the Left and Right Arm Panels
- Footrest and Back operate Independently of One Another
- Back can be Infinitely Positioned to any Sleep Position Angle
- Upholstered Arms, Seat and Back
- Tight Cushion
- Warm Grey (with Silver Ion Antimicrobial) Powder Coated Steel Foot Release Lever
- 5" Fixed Casters in Front, 5" Swivel Rear Casters with Brake

WINGBACK RECLINER WITH TRENDELENBURG

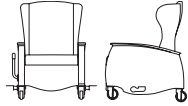

w	outside d	h	sw	seat sd	sh	seat to top of back	arm height	extended length	weight lbs.	cubic feet
39	36	47	24	20	20.25	28.5	28	75	200	50

model	yds com (54")	sq ft col	com 1	col 2	3	4	5	6	7	8	9	10	11	12	13	14	15	L1	L2	L3
1417-W	7	n/a	5,161	5,276	5,408	5,572	5,803	6,132	6,461	6,790	7,120	7,449	7,778	8,107	8,436	8,765	9,094	6,554	6,886	7,211

OPTIONS

Arm Caps and Arm Rests	Arm	Attachments	Seat Back	Caster and Base	Removable Covers	Head Rest	Fabric 1
Standard X9 No Arm Cap	Standard X9 No Selection of Option	Standard X9 No Selection of Option	Standard X9 No Selection of Option	Standard X9 No Selection of Option	Standard X9 No Selection of Option	Standard X9 No Selection of Option	Selection Required
Arm Caps A3 Wood (specify finish) \$247 pair Black Poly Arm Caps H3S Left Side Facing \$155 H3T Right Side Facing \$155 A4 Pair \$309 Ergo Arm Rests G1G Left Side Facing \$246 G1H Right Side Facing \$246 H3R Pair \$492	E1N Fold-Down (right side facing) \$570 NOTE: E1N option not available with G1H or H3R Ergo Arm Rests	K9 3DL Drop Table - Right Facing (specify color) (not available with fold-down arm option) \$183 DBH Hook \$93 NOTE: DBH Hook is field installed Heated Seat and Back H1C Standard power cord \$313 H1D Fully retractable power cord \$1,181	L2 Push Bar \$152 H1Z Padded Push Bar \$284 L4 Back Bump Guard \$183	CLC Central Locking Casters \$980 E1K Pull-Out Foot Tray \$246	B1L Removable Seat Cover only \$125	G1F Head Pillow (attached with velcro for comfort and adjustability) (see pricing below)	Fabric: Grade, Vendor, Pattern, Color NOTE: For multiple fabric applications see page 14 for information and pricing

Head Rest Options

yds com (54")	sq ft col	com 1	col 2	3	4	5	6	7	8	9	10	11	12	13	14	15	L1	L2	L3
0.75	n/a	85	97	111	129	154	189	224	260	295	330	365	401	436	471	506	259	295	330

HOW TO ORDER

SPECIFY: Arm caps and arm rests | arm cap finish (if applicable) | arm | attachments | seat back | caster and base | removable covers | head rest | textile pattern and color. See pages 5-14 for information and options on moisture barrier, CAL133, upholstery applications, a complete offering of finishes and ordering details.

MODEL NUMBER

1417-W

Arm Caps and Arm Rests	Arm	Attachments	Seat Back	Caster and Base	Removable Covers	Head Rest	Fabric 1
A3 - MLC	E1N	K9 - LC3	L2	CLC	B1L	G1F	Grade 5, Momentum, Row, Breeze

ORCHESTRA GLIDER RECLINER STANDARD FEATURES

- Durable Steel Recliner Mechanism with Automatic Lock-Out when Reclined
- Upholstered Arms, Seat and Back
- Warm Grey (with Silver Ion Antimicrobial) Powder Coated Steel Lock-Out Lever
- Footrest and Back operate Independently of One Another
- Tight Cushion
- European Beech Front Legs (must specify finish)
- Back can be Infinitely Positioned to any Sleep Position Angle
- Warm Grey (with Silver Ion Antimicrobial) Powder Coated Steel Foot Release Lever
- Black Cylinder Back Legs
- Non-Marring Adjustable Glides

GLIDER RECLINER

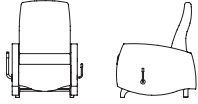

w	outside			sw	seat			seat to top of back	arm height	extended length	weight lbs.	cubic feet
	d	h			sd	sh						
35.75	36	45		24	20	19	26	26	75	165	38	

model	yds com (54")	sq ft col	com 1	col 2	3	4	5	6	7	8	9	10	11	12	13	14	15	L1	L2	L3
1408-GR	5.75	n/a	3,591	3,686	3,794	3,929	4,118	4,389	4,659	4,929	5,200	5,470	5,741	6,011	6,281	6,552	6,822	4,740	5,013	5,280

OPTIONS

Arm Caps and Arm Rests	Attachments	Seat Back	Caster	Removable Covers	Head Rest	Fabric 1
Standard X9 No Arm Cap	Standard X9 No Selection of Option	Standard X9 No Selection of Option	Standard X9 No Selection of Option	Standard X9 No Selection of Option	Standard X9 No Selection of Option	Selection Required
Arm Caps A3 Wood (specify finish) \$247 pair Black Poly Arm Caps H3S Left Side Facing \$155 H3T Right Side Facing \$155 A4 Pair \$309 Ergo Arm Rests G1G Left Side Facing \$246 G1H Right Side Facing \$246 H3R Pair \$492	K9 3DL Drop Table - Right Facing (specify color) (not available with fold-down arm option) \$183 DBH Hook \$93 NOTE: DBH Hook is field installed	L2 Push Bar \$152 H1Z Padded Push Bar \$284 L4 Back Bump Guard \$183	D1D Rear Locking (set of 2) \$183	H7 Removable Seat and Back Covers (back cover not available with adjustable head rest) \$249 B1L Removable Seat Cover only \$125 B1M Removable Back Cover only (back cover not available with adjustable head rest) \$125	G1F Head Pillow (attached with velcro for comfort and adjustability) (see pricing below) FIW Single Adjustable Head Rest (see pricing below) FIX Double Adjustable Head Rest (see pricing below)	Fabric: Grade, Vendor, Pattern, Color NOTE: For multiple fabric applications see page 14 for information and pricing

Head Rest Options G1F

yds com (54")	sq ft col	com 1	col 2	3	4	5	6	7	8	9	10	11	12	13	14	15	L1	L2	L3
0.75	n/a	85	97	111	129	154	189	224	260	295	330	365	401	436	471	506	259	295	330

Head Rest Options FIW

yds com (54")	sq ft col	com 1	col 2	3	4	5	6	7	8	9	10	11	12	13	14	15	L1	L2	L3
0.75	n/a	614	626	640	658	683	718	753	789	824	859	894	930	965	1,000	1,035	788	824	859

Head Rest Options FIX

yds com (54")	sq ft col	com 1	col 2	3	4	5	6	7	8	9	10	11	12	13	14	15	L1	L2	L3
0.75	n/a	1,114	1,126	1,140	1,158	1,183	1,218	1,253	1,289	1,324	1,359	1,394	1,430	1,465	1,500	1,535	1,288	1,324	1,359

HOW TO ORDER

SPECIFY: Arm caps and arm rests | arm cap finish (if applicable) | attachments | seat back | caster | removable covers | head rest | textile pattern and color. See pages 5-14 for information and options on moisture barrier, CAL133, upholstery applications, a complete offering of finishes and ordering details.

MODEL NUMBER

1408-GR

Arm Caps and Arm Rests	Attachments	Seat Back	Caster	Removable Covers	Head Rest	Fabric 1
A3 - MLC	K9 - LC3	L2	D1D	H7	G1F	Grade 5, Momentum, Row, Breeze

ORCHESTRA MINI RECLINER STANDARD FEATURES

- Durable Steel Recliner Mechanism
- Upholstered Seat and Back
- Tight Cushion
- European Beech Open Arm Frame with Wood Arm Cap
- European Beech Exterior Frame
- Non-Marring Adjustable Glides

MINI RECLINER

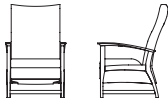

w	outside d	h	sw	seat sd	sh	seat to top of back	arm height	extended length	weight lbs.	cubic feet
27	32	42.5	22.5	20	18	24.5	25	62	87	38

model	yds com (54")	sq ft col	com 1	col 2	3	4	5	6	7	8	9	10	11	12	13	14	15	L1	L2	L3
1487-R	3.75	n/a	2,515	2,577	2,647	2,735	2,859	3,035	3,212	3,388	3,564	3,741	3,917	4,093	4,270	4,446	4,622	3,274	3,452	3,626

OPTIONS

Arm Caps	Finish	Seat Back	Removable Covers	Fabric 1
Standard A3 Wood (specify finish)	Selection Required	Standard X9 No Selection of Option	Standard X9 No Selection of Option	Selection Required
A4 Poly (black) \$309 pair	See page 9 for full list of finish options	L4 Back Bump Guard \$183	H7 Removable Seat and Back Covers \$221 B1L Removable Seat Cover only \$111 B1M Removable Back Cover only \$111	NOTE: For multiple fabric applications see page 14 for information and pricing

HOW TO ORDER

SPECIFY: Arm caps | wood finish | seat back | removable covers | textile pattern and color. See pages 5-14 for information and options on moisture barrier, CAL133, upholstery applications, a complete offering of finishes and ordering details.

MODEL NUMBER

1487-R

Arm Caps	Finish	Seat Back	Removable Covers	Fabric 1
A3	MHM	L4	H7	Grade 5, Momentum, Row, Breeze

VOYAGE THREE-POSITION RECLINER STANDARD FEATURES

- Durable Steel Recliner Mechanism
- Upholstered Arms on 1577
- Upholstered Seat and Back
- European Beech Open Arm Frame on 1577WA
- Tight Cushion
- 3" Swivel Casters in Front, 3" Rear Casters with Brake
- Optional Trendelenburg Mechanism Activated via a Release Lever located on the Outside Back of the Recliner

THREE-POSITION RECLINER, CLOSED ARM

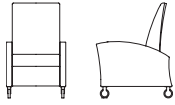

w	outside d	h	sw	seat sd	sh	seat to top of back	arm height	extended length	weight lbs.	cubic feet
27.5	33	44	21.5	20.5	19.5	24.5	26.25	64	90	38

model	yds com (54")	sq ft col	com 1	col 2	3	4	5	6	7	8	9	10	11	12	13	14	15	L1	L2	L3
1577	5.75	n/a	2,560	2,655	2,763	2,898	3,087	3,358	3,628	3,898	4,169	4,439	4,710	4,980	5,250	5,521	5,791	3,709	3,982	4,249

THREE-POSITION RECLINER, OPEN ARM

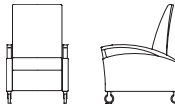

w	outside d	h	sw	seat sd	sh	seat to top of back	arm height	extended length	weight lbs.	cubic feet
27.5	33	44	21.5	20.5	19.5	24.5	26.25	64	90	38

model	yds com (54")	sq ft col	com 1	col 2	3	4	5	6	7	8	9	10	11	12	13	14	15	L1	L2	L3
1577WA	5.75	n/a	2,967	3,062	3,170	3,305	3,494	3,765	4,035	4,305	4,576	4,846	5,117	5,387	5,657	5,928	6,198	4,116	4,389	4,656

OPTIONS

Arm Caps	Finish (1577WA only)	Attachments	Seat Back	Mechanism	Fabric 1
Standard X9 No Arm Cap	Selection Required	Standard X9 No Selection of Option	Standard X9 No Selection of Option	Standard X9 No Selection of Option	Selection Required
A4 Poly (black) \$309 pair	See page 9 for full list of finish options	K9 3DL Drop Table - Right Facing (specify color) \$183 DBH Hook \$93 NOTE: DBH Hook is field installed	L2 Push Bar \$152 L4 Back Bump Guard \$183	L3 Trendelenburg \$238	Fabric: Grade, Vendor, Pattern, Color NOTE: For multiple fabric applications see page 14 for information and pricing

HOW TO ORDER

SPECIFY: Arm caps | wood finish (1577WA only) | attachments | seat back | mechanism | textile pattern and color. See pages 5-14 for information and options on moisture barrier, CAL133, upholstery applications, a complete offering of finishes and ordering details.

MODEL NUMBER

1577WA

Arm Caps	Finish (1577WA only)	Attachments	Seat Back	Mechanism	Fabric 1
X9	MLC	K9 - LC3	L2	L3	Grade 5, Momentum, Row, Breeze

VOYAGE CLOSED ARM RECLINER STANDARD FEATURES

- Durable Steel Recliner Mechanism
- Footrest and Back operate Independently of One Another
- Back can be Infinitely Positioned to any Sleep Position Angle
- Upholstered Arm Panels, Seat and Back
- Tight Cushion
- Warm Grey (with Silver Ion Antimicrobial) Powder Coated Steel Foot Release Lever
- 5" Fixed Casters in Front, 5" Swivel Rear Casters with Brake

CLOSED ARM RECLINER

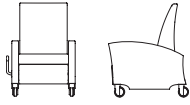

w	outside d	h	sw	seat sd	sh	seat to top of back	arm height	extended length	weight lbs.	cubic feet
34	37.5	45.25	24	21	21	24.25	27.5	72	133	38

model	yds com (54")	sq ft col	com 1	col 2	3	4	5	6	7	8	9	10	11	12	13	14	15	L1	L2	L3
1507TR	5.5	n/a	3,392	3,483	3,586	3,715	3,896	4,155	4,414	4,672	4,931	5,189	5,448	5,707	5,965	6,224	6,483	4,492	4,753	5,009

OPTIONS

Arm Caps and Arm Rests	Arm	Attachments	Seat Back	Caster and Base	Removable Covers	Head Rest	Fabric 1
Standard X9 No Arm Cap	Standard X9 No Selection of Option	Standard X9 No Selection of Option	Standard X9 No Selection of Option	Standard X9 No Selection of Option	Standard X9 No Selection of Option	Standard X9 No Selection of Option	Selection Required
Black Poly Arm Caps H35 Left Side Facing \$155 H3T Right Side Facing \$155 A4 Pair \$309 Ergo Arm Rests G1G Left Side Facing \$246 G1H Right Side Facing \$246 H3R Pair \$492	E1N Fold-Down (right side facing) \$570 NOTE: E1N option not available with G1H or H3R Ergo Arm Rests	K9 3DL Drop Table - Right Facing (specify color) (not available with fold-down arm option) \$183 DBH Hook \$93 NOTE: DBH Hook is field installed Heated Seat and Back H1C Standard power cord \$313 H1D Fully retractable power cord \$1,181	L2 Push Bar \$152 H1Z Padded Push Bar \$284 L4 Back Bump Guard \$183	CLC Central Locking Casters \$980 E1K Pull-Out Foot Tray \$246	H7 Removable Seat and Back Covers (back cover not available with adjustable head rest) \$249 B1L Removable Seat Cover only \$125 B1M Removable Back Cover only (back cover not available with adjustable head rest) \$125	G1F Head Pillow (attached with velcro for comfort and adjustability) (see pricing below) F1W Single Adjustable Head Rest (see pricing below) F1X Double Adjustable Head Rest (see pricing below)	Fabric: Grade, Vendor, Pattern, Color NOTE: For multiple fabric applications see page 14 for information and pricing

Head Rest Options G1F

yds com (54")	sq ft col	com 1	col 2	3	4	5	6	7	8	9	10	11	12	13	14	15	L1	L2	L3
0.75	n/a	84	96	110	128	153	188	223	259	294	329	364	400	435	470	505	258	294	329

Head Rest Options F1W

yds com (54")	sq ft col	com 1	col 2	3	4	5	6	7	8	9	10	11	12	13	14	15	L1	L2	L3
0.75	n/a	611	623	637	655	680	715	750	786	821	856	891	927	962	997	1,032	785	821	856

Head Rest Options F1X

yds com (54")	sq ft col	com 1	col 2	3	4	5	6	7	8	9	10	11	12	13	14	15	L1	L2	L3
0.75	n/a	1,108	1,120	1,134	1,152	1,177	1,212	1,247	1,283	1,318	1,353	1,388	1,424	1,459	1,494	1,529	1,282	1,318	1,353

HOW TO ORDER

SPECIFY: Arm caps and arm rests | arm | attachments | seat back | caster and base | removable covers | head rest | textile pattern and color. See pages 5-14 for information and options on moisture barrier, CAL133, upholstery applications, a complete offering of finishes and ordering details.

MODEL NUMBER

1507TR

Arm Caps and Arm Rests	Arm	Attachments	Seat Back	Caster and Base	Removable Covers	Head Rest	Fabric 1
A4	E1N	K9 - LC3	L2	CLC	H7	G1F	Grade 5, Momentum, Row, Breeze

VOYAGE OPEN ARM RECLINER STANDARD FEATURES

- Durable Steel Recliner Mechanism
- Upholstered Arm Panels, Seat and Back
- Warm Grey (with Silver Ion Antimicrobial) Powder Coated Steel Foot Release Lever
- Footrest and Back operate Independently of One Another
- European Beech Open Arm Frame on Top of Arm Panel
- 5" Fixed Casters in Front, 5" Swivel Rear Casters with Brake
- Back can be Infinitely Positioned to any Sleep Position Angle
- Tight Cushion

OPEN ARM RECLINER

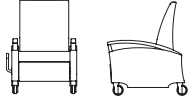

	outside			seat			seat to top	arm	extended	weight	cubic
	w	d	h	sw	sd	sh	of back	height	length	lbs.	feet
	34	37.5	45.25	24	21	21	24.25	27.5	72	133	38

model	yds com (54")	sq ft col	com 1	col 2	3	4	5	6	7	8	9	10	11	12	13	14	15	L1	L2	L3
1507WA	5.5	n/a	3,825	3,916	4,019	4,148	4,329	4,588	4,847	5,105	5,364	5,622	5,881	6,140	6,398	6,657	6,916	4,925	5,186	5,442

OPTIONS

Arm Caps	Finish	Attachments	Seat Back	Caster and Base	Removable Covers	Head Rest	Fabric 1
Standard X9 No Arm Cap	Selection Required	Standard X9 No Selection of Option	Standard X9 No Selection of Option	Standard X9 No Selection of Option	Standard X9 No Selection of Option	Standard X9 No Selection of Option	Selection Required
A4 Poly (black) \$309 pair	See page 9 for full list of finish options	K9 3DL Drop Table - Right Facing (specify color) \$183 DBH Hook \$93 NOTE: DBH Hook is field installed	L2 Push Bar \$152 HIZ Padded Push Bar \$284 L4 Back Bump Guard \$183	CLC Central Locking Casters \$980 EIK Pull-Out Foot Tray \$246	H7 Removable Seat and Back Covers (back cover not available with adjustable head rest) \$249 B1L Removable Seat Cover only \$125 B1M Removable Back Cover only (back cover not available with adjustable head rest) \$125	G1F Head Pillow (attached with velcro for comfort and adjustability) (see pricing below) F1W Single Adjustable Head Rest (see pricing below) F1X Double Adjustable Head Rest (see pricing below)	Fabric: Grade, Vendor, Pattern, Color NOTE: For multiple fabric applications see page 14 for information and pricing

Head Rest Options G1F

yds com (54")	sq ft col	com 1	col 2	3	4	5	6	7	8	9	10	11	12	13	14	15	L1	L2	L3
0.75	n/a	84	96	110	128	153	188	223	259	294	329	364	400	435	470	505	258	294	329

Head Rest Options F1W

yds com (54")	sq ft col	com 1	col 2	3	4	5	6	7	8	9	10	11	12	13	14	15	L1	L2	L3
0.75	n/a	611	623	637	655	680	715	750	786	821	856	891	927	962	997	1,032	785	821	856

Head Rest Options F1X

yds com (54")	sq ft col	com 1	col 2	3	4	5	6	7	8	9	10	11	12	13	14	15	L1	L2	L3
0.75	n/a	1,108	1,120	1,134	1,152	1,177	1,212	1,247	1,283	1,318	1,353	1,388	1,424	1,459	1,494	1,529	1,282	1,318	1,353

HOW TO ORDER

SPECIFY: Arm caps | wood finish | attachments | seat back | caster and base | removable covers | head rest | textile pattern and color. See pages 5-14 for information and options on moisture barrier, CAL133, upholstery applications, a complete offering of finishes and ordering details.

MODEL NUMBER

1507WA

Arm Caps	Finish	Attachments	Seat Back	Caster and Base	Removable Covers	Head Rest	Fabric 1
X9	MLC	K9 - LC3	L2	CLC	H7	G1F	Grade 5, Momentum, Row, Breeze

VOYAGE BARIATRIC RECLINER STANDARD FEATURES

- Rated for 750 lbs.
- Durable Steel Recliner Mechanism
- Footrest and Back operate Independently of One Another
- Back can be Infinitely Positioned to any Sleep Position Angle
- Upholstered Seat and Back
- Upholstered Arms on 1507-OB
- Upholstered Arm Panels with European Beech Open Arm Frame on 1507WA-OB
- Tight Cushion
- Warm Grey (with Silver Ion Antimicrobial) Powder Coated Steel Foot Release Lever
- 5" Fixed Casters in Front, 5" Swivel Rear Casters with Brake

CLOSED ARM BARIATRIC RECLINER

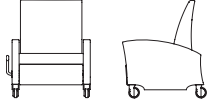

w	outside			sw	seat			seat to top of back	arm height	extended length	weight lbs.	cubic feet
	d	h			sd	sh						
39	37.5	45.25		29	21	21	24.25	27.5	72	153	50	

model	yds com (54")	sq ft col	com 1	col 2	3	4	5	6	7	8	9	10	11	12	13	14	15	L1	L2	L3
1507-OB	6.5	n/a	3,706	3,813	3,935	4,088	4,302	4,608	4,913	5,219	5,525	5,830	6,136	6,442	6,747	7,053	7,359	5,001	5,309	5,612

OPEN ARM BARIATRIC RECLINER

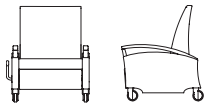

w	outside			sw	seat			seat to top of back	arm height	extended length	weight lbs.	cubic feet
	d	h			sd	sh						
39	37.5	45.25		29	21	21	24.25	27.5	72	153	50	

model	yds com (54")	sq ft col	com 1	col 2	3	4	5	6	7	8	9	10	11	12	13	14	15	L1	L2	L3
1507WA-OB	6.5	n/a	4,147	4,254	4,376	4,529	4,743	5,049	5,354	5,660	5,966	6,271	6,577	6,883	7,188	7,494	7,800	5,442	5,750	6,053

OPTIONS

Arm Caps and Arm Rests	Finish (1507WA-OB only)	Attachments	Seat Back	Caster and Base	Removable Covers	Head Rest	Fabric 1
Standard X9 No Arm Cap	Selection Required	Standard X9 No Selection of Option	Standard X9 No Selection of Option	Standard X9 No Selection of Option	Standard X9 No Selection of Option	Standard X9 No Selection of Option	Selection Required
Black Poly Arm Caps H35 Left Side Facing \$155 H3T Right Side Facing \$155 A4 Pair \$309 Ergo Arm Rests (not available on 1507WA-OB) G1G Left Side Facing \$246 G1H Right Side Facing \$246 H3R Pair \$492	See page 9 for full list of finish options	K9 3DL Drop Table - Right Facing (specify color) \$183 DBH Hook \$93 NOTE: DBH Hook is field installed Heated Seat and Back H1C Standard power cord (not available on 1507WA-OB) \$313 H1D Fully retractable power cord (not available on 1507WA-OB) \$1,181	L2 Push Bar \$152 H1Z Padded Push Bar \$284 L4 Back Bump Guard \$183	CLC Central Locking Casters \$980 E1K Pull-Out Foot Tray \$246	H7 Removable Seat and Back Covers \$249 B1L Removable Seat Cover only \$125 B1M Removable Back Cover only \$125	G1F Head Pillow (attached with velcro for comfort and adjustability) (see pricing below)	Fabric: Grade, Vendor, Pattern, Color NOTE: For multiple fabric applications see page 14 for information and pricing

Head Rest Options

yds com (54")	sq ft col	com 1	col 2	3	4	5	6	7	8	9	10	11	12	13	14	15	L1	L2	L3
0.75	n/a	84	96	110	128	153	188	223	259	294	329	364	400	435	470	505	258	294	329

HOW TO ORDER

SPECIFY: Arm caps | wood finish (1507WA-OB only) | attachments | seat back | caster and base | removable covers | head rest | textile pattern and color. See pages 5-14 for information and options on moisture barrier, CAL133, upholstery applications, a complete offering of finishes and ordering details.

MODEL NUMBER

1507WA-OB

Arm Caps and Arm Rests	Finish (1507WA-OB only)	Attachments	Seat Back	Caster and Base	Removable Covers	Head Rest	Fabric 1
X9	MLC	K9 - LC3	L2	CLC	H7	G1F	Grade 5, Momentum, Row, Breeze

VOYAGE CLOSED ARM RECLINER WITH TRENDELEBURG STANDARD FEATURES

- Painted Heavy Gauge Stamped Steel Lay Flat Recliner Mechanism with Heavy Steel Trendelenburg Release
- Trendelenburg Mechanism Activated via a Release Lever located at the Bottom of the Left and Right Arm Panels
- Footrest and Back operate Independently of One Another
- Back can be Infinitely Positioned to any Sleep Position Angle
- Upholstered Arms, Seat and Back
- Tight Cushion
- Warm Grey (with Silver Ion Antimicrobial) Powder Coated Steel Foot Release Lever
- 5" Fixed Casters in Front, 5" Swivel Rear Casters with Brake

CLOSED ARM RECLINER WITH TRENDELEBURG

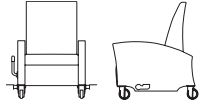

w	outside d	h	sw	seat sd	sh	seat to top of back	arm height	extended length	weight lbs.	cubic feet
42	37.5	45.25	24	21	21	24.25	27.5	72	198	50

model	yds com (54")	sq ft col	com 1	col 2	3	4	5	6	7	8	9	10	11	12	13	14	15	L1	L2	L3
1517TR	6	n/a	4,731	4,830	4,943	5,084	5,281	5,563	5,845	6,128	6,410	6,692	6,974	7,256	7,538	7,820	8,103	5,929	6,213	6,492

OPTIONS

Arm Caps and Arm Rests	Arm	Attachments	Seat Back	Caster and Base	Removable Covers	Head Rest	Fabric 1
Standard X9 No Arm Cap	Standard X9 No Selection of Option	Standard X9 No Selection of Option	Standard X9 No Selection of Option	Standard X9 No Selection of Option	Standard X9 No Selection of Option	Standard X9 No Selection of Option	Selection Required
Black Poly Arm Caps \$155 H35 Left Side Facing \$155 H3T Right Side Facing \$155 A4 Pair \$309 Ergo Arm Rests G1G Left Side Facing \$246 G1H Right Side Facing \$246 H3R Pair \$492	E1N Fold-Down (right side facing) \$570 NOTE: E1N option not available with G1H or H3R Ergo Arm Rests	K9 3DL Drop Table - Right Facing (specify color) (not available with fold-down arm option) \$183 DBH Hook \$93 NOTE: DBH Hook is field installed Heated Seat and Back H1C Standard power cord \$313 H1D Fully retractable power cord \$1,181	L2 Push Bar \$148 H1Z Padded Push Bar \$284 L4 Back Bump Guard \$183	CLC Central Locking Casters \$980 E1K Pull-Out Foot Tray \$246	H7 Removable Seat and Back Covers (back cover not available with adjustable head rest) \$249 B1L Removable Seat Cover only \$125 B1M Removable Back Cover only (back cover not available with adjustable head rest) \$125	G1F Head Pillow (attached with velcro for comfort and adjustability) (see pricing below) F1W Single Adjustable Head Rest (see pricing below) F1X Double Adjustable Head Rest (see pricing below)	Fabric: Grade, Vendor, Pattern, Color NOTE: For multiple fabric applications see page 14 for information and pricing

Head Rest Options G1F

yds com (54")	sq ft col	com 1	col 2	3	4	5	6	7	8	9	10	11	12	13	14	15	L1	L2	L3
0.75	n/a	84	96	110	128	153	188	223	259	294	329	364	400	435	470	505	258	294	329

Head Rest Options F1W

yds com (54")	sq ft col	com 1	col 2	3	4	5	6	7	8	9	10	11	12	13	14	15	L1	L2	L3
0.75	n/a	611	623	637	655	680	715	750	786	821	856	891	927	962	997	1,032	785	821	856

Head Rest Options F1X

yds com (54")	sq ft col	com 1	col 2	3	4	5	6	7	8	9	10	11	12	13	14	15	L1	L2	L3
0.75	n/a	1,108	1,120	1,134	1,152	1,177	1,212	1,247	1,283	1,318	1,353	1,388	1,424	1,459	1,494	1,529	1,282	1,318	1,353

HOW TO ORDER

SPECIFY: Arm caps and arm rests | arm | attachments | seat back | caster and base | removable covers | head rest | textile pattern and color. See pages 5-14 for information and options on moisture barrier, CAL133, upholstery applications, a complete offering of finishes and ordering details.

MODEL NUMBER

1517TR

Arm Caps and Arm Rests	Arm	Attachments	Seat Back	Caster and Base	Removable Covers	Head Rest	Fabric 1
A4	E1N	K9 - LC3	L2	CLC	H7	G1F	Grade 5, Momentum, Row, Breeze

VOYAGE OPEN ARM RECLINER WITH TRENDELENBURG STANDARD FEATURES

- Painted Heavy Gauge Stamped Steel Lay Flat Recliner Mechanism with Heavy Steel Trendelenburg Release
- Trendelenburg Mechanism Activated via a Release Lever located at the Bottom of the Left and Right Arm Panels
- Footrest and Back operate Independently of One Another
- Back can be Infinitely Positioned to any Sleep Position Angle
- Upholstered Arm Panels, Seat and Back
- European Beech Open Arm Frame on Top of Arm Panel
- Tight Cushion
- Warm Grey (with Silver Ion Antimicrobial) Powder Coated Steel Foot Release Lever
- 5" Fixed Casters in Front, 5" Swivel Rear Casters with Brake

OPEN ARM RECLINER WITH TRENDELENBURG

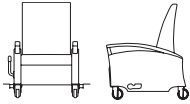

w	outside d	h	sw	seat sd	sh	seat to top of back	arm height	extended length	weight lbs.	cubic feet
42	37.5	45.25	24	21	21	24.25	27.5	72	198	50

model	yds com (54")	sq ft col	com 1	col 2	3	4	5	6	7	8	9	10	11	12	13	14	15	L1	L2	L3
1517WA	6	n/a	5,121	5,220	5,333	5,474	5,671	5,953	6,235	6,518	6,800	7,082	7,364	7,646	7,928	8,210	8,493	6,319	6,603	6,882

OPTIONS

Arm Caps	Finish	Attachments	Seat Back	Caster and Base	Removable Covers	Head Rest	Fabric 1
Standard X9 No Arm Cap	Selection Required	Standard X9 No Selection of Option	Standard X9 No Selection of Option	Standard X9 No Selection of Option	Standard X9 No Selection of Option	Standard X9 No Selection of Option	Selection Required
A4 Poly (black) \$309 pair	See page 9 for full list of finish options	K9 3DL Drop Table - Right Facing (specify color) \$183 DBH Hook \$93 NOTE: DBH Hook is field installed	L2 Push Bar \$152 H1Z Padded Push Bar \$284 L4 Back Bump Guard \$183	CLC Central Locking Casters \$980 E1K Pull-Out Foot Tray \$246	H7 Removable Seat and Back Covers (back cover not available with adjustable head rest) \$249 B1L Removable Seat Cover only \$125 B1M Removable Back Cover only (back cover not available with adjustable head rest) \$125	G1F Head Pillow (attached with velcro for comfort and adjustability) (see pricing below) F1W Single Adjustable Head Rest (see pricing below) F1X Double Adjustable Head Rest (see pricing below)	Fabric: Grade, Vendor, Pattern, Color NOTE: For multiple fabric applications see page 14 for information and pricing

Head Rest Options G1F

yds com (54")	sq ft col	com 1	col 2	3	4	5	6	7	8	9	10	11	12	13	14	15	L1	L2	L3
0.75	n/a	84	96	110	128	153	188	223	259	294	329	364	400	435	470	505	258	294	329

Head Rest Options F1W

yds com (54")	sq ft col	com 1	col 2	3	4	5	6	7	8	9	10	11	12	13	14	15	L1	L2	L3
0.75	n/a	611	623	637	655	680	715	750	786	821	856	891	927	962	997	1,032	785	821	856

Head Rest Options F1X

yds com (54")	sq ft col	com 1	col 2	3	4	5	6	7	8	9	10	11	12	13	14	15	L1	L2	L3
0.75	n/a	1,108	1,120	1,134	1,152	1,177	1,212	1,247	1,283	1,318	1,353	1,388	1,424	1,459	1,494	1,529	1,282	1,318	1,353

HOW TO ORDER

SPECIFY: Arm caps | wood finish | attachments | seat back | caster and base | removable covers | head rest | textile pattern and color. See pages 5-14 for information and options on moisture barrier, CAL133, upholstery applications, a complete offering of finishes and ordering details.

MODEL NUMBER

1517WA

Arm Caps	Finish	Attachments	Seat Back	Caster and Base	Removable Covers	Head Rest	Fabric 1
X9	MLC	K9 - LC3	L2	CLC	H7	G1F	Grade 5, Momentum, Row, Breeze

AMICO SLEEP CHAIR AND LOVESEAT STANDARD FEATURES

- Multi-Position Steel Frame Mechanism
- Upholstered Arms, Seat and Back
- Tight Cushions
- Two 2" Locking Casters on Back, Coalbox Caster in Front of 1659-2SC
- Non-Marring Adjustable Glides
- NOTE: When in Sleep Position do not Sit or Stand on Back

SLEEP CHAIR

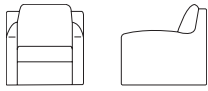

w	outside			sw	seat			seat to top	arm	extended	sleep surface	weight	cubic
	d	h		sd	sh	of back	height	length	length	length	lbs.	feet	
32	37.5	33.5		25.5	22	18	20	25	85.5	82	150	29	

model	yds com (54")	sq ft col	com 1	col 2	3	4	5	6	7	8	9	10	11	12	13	14	15	L1	L2	L3
1659-S	8.25	n/a	3,057	3,193	3,348	3,542	3,813	4,201	4,589	4,977	5,365	5,753	6,141	6,529	6,917	7,305	7,693	4,693	5,084	5,469

SLEEP LOVESEAT WITH CASTERS

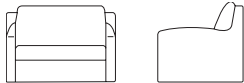

w	outside			sw	seat			seat to top	arm	extended	sleep surface	weight	cubic
	d	h		sd	sh	of back	height	length	length	length	length	lbs.	feet
53.5	37.5	33.5		47	22	18	20	25	89	82	185	49	

model	yds com (54")	sq ft col	com 1	col 2	3	4	5	6	7	8	9	10	11	12	13	14	15	L1	L2	L3
1659-2SC	10.25	n/a	4,259	4,428	4,620	4,861	5,199	5,681	6,163	6,645	7,127	7,609	8,091	8,573	9,055	9,537	10,019	6,285	6,771	7,248

OPTIONS

Arm Caps	Caster	Fabric 1
Standard X9 No Arm Cap	Standard X9 No Casters (1659-S) Back Locking (1659-2SC)	Selection Required
A3 Wood (specify finish) \$183 pair A4 Poly (black) \$247 pair	K8 Casters (set of 4) (2 locking) (available on 1659-S) \$288	Fabric: Grade, Vendor, Pattern, Color NOTE: For multiple fabric applications see page 14 for information and pricing

HOW TO ORDER

SPECIFY: Arm caps | arm cap finish (if applicable) | caster | textile pattern and color. See pages 5-14 for information and options on moisture barrier, CAL133, upholstery applications, a complete offering of finishes and ordering details.

MODEL NUMBER

1659-S

Arm Caps	Caster	Fabric 1
A3 - MLC	K8	Grade 5, Momentum, Row, Breeze

CORONADO SLEEP CHAIR AND LOVESEAT STANDARD FEATURES

- Multi-Position Steel Frame Mechanism
- Upholstered Arms, Seat and Back
- Tight Cushions
- Two 2" Locking Casters on Back, Two Non-Locking on Front of 1759-2SC
- Non-Marring Adjustable Glides
- NOTE: When in Sleep Position do not Sit or Stand on Back

SLEEP CHAIR

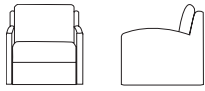

w	outside			sw	seat			seat to top of back	arm height	extended length	sleep surface length	weight lbs.	cubic feet
	d	h			sd	sh							
32	35	33.5		25.5	22	18		20	25	85.5	82	150	29

model	yds com (54")	sq ft col	com 1	col 2	3	4	5	6	7	8	9	10	11	12	13	14	15	L1	L2	L3
1759-S	8.25	n/a	3,057	3,193	3,348	3,542	3,813	4,201	4,589	4,977	5,365	5,753	6,141	6,529	6,917	7,305	7,693	4,693	5,084	5,469

SLEEP LOVESEAT WITH CASTERS

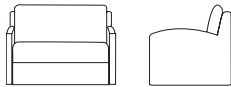

w	outside			sw	seat			seat to top of back	arm height	extended length	sleep surface length	weight lbs.	cubic feet
	d	h			sd	sh							
53.5	35	33.5		47	22	18		20	25	85.5	82	185	49

model	yds com (54")	sq ft col	com 1	col 2	3	4	5	6	7	8	9	10	11	12	13	14	15	L1	L2	L3
1759-2SC	10.25	n/a	4,259	4,428	4,620	4,861	5,199	5,681	6,163	6,645	7,127	7,609	8,091	8,573	9,055	9,537	10,019	6,285	6,771	7,248

OPTIONS

Arm Caps	Caster	Fabric 1
Standard X9 No Arm Cap	Standard X9 No Casters (1759-S) Back Locking (1759-2SC)	Selection Required
A3 Wood (specify finish) \$183 pair A4 Poly (black) \$247 pair	K8 Casters (set of 4) (2 locking) (available on 1759-S) \$288	Fabric: Grade, Vendor, Pattern, Color NOTE: For multiple fabric applications see page 14 for information and pricing

HOW TO ORDER

SPECIFY: Arm caps | arm cap finish (if applicable) | caster | textile pattern and color. See pages 5-14 for information and options on moisture barrier, CAL133, upholstery applications, a complete offering of finishes and ordering details.

MODEL NUMBER

1759-S

Arm Caps	Caster	Fabric 1
A3 - MLC	K8	Grade 5, Momentum, Row, Breeze

RETROSPECT SLEEP SOFA STANDARD FEATURES

- Armless
- Upholstered Seat and Back
- Loose Folding Back Cushion
- Tight Seat Cushion
- Beige Antimicrobial Sleep Surface
- Two Upholstered Drawers
- 3.5" Machine Turned Satin Aluminum Legs
- Non-Marring Adjustable Glides
- 7" x 15" Veneer or HPL Tablet with Exposed Wood Edge and Satin Aluminum Finished Swivel Arm

76" SLEEP SOFA

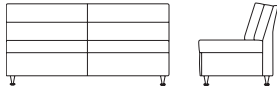

w	outside			sw	seat		seat to top of back	arm height	sleep surface		weight lbs.	cubic feet
	d	h	sd		sh	l			w			
76	34	33	76	19.5	19.5	15	23.5	76	30	185	88	

model	yds com (54")	sq ft col	com 1	col 2	3	4	5	6	7	8	9	10	11	12	13	14	15	L1	L2	L3
7058-S76	11	n/a	3,623	3,804	4,011	4,270	4,632	5,149	5,666	6,183	6,701	7,218	7,735	8,252	8,770	9,287	9,804	5,796	6,317	6,829

80" SLEEP SOFA

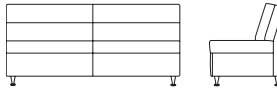

w	outside			sw	seat		seat to top of back	arm height	sleep surface		weight lbs.	cubic feet
	d	h	sd		sh	l			w			
80	34	33	80	19.5	19.5	15	23.5	76	30	185	88	

model	yds com (54")	sq ft col	com 1	col 2	3	4	5	6	7	8	9	10	11	12	13	14	15	L1	L2	L3
7058-S80	11.5	n/a	3,844	4,033	4,250	4,520	4,898	5,439	5,980	6,521	7,062	7,602	8,143	8,684	9,225	9,765	10,306	6,114	6,659	7,194

OPTIONS

Arm Styles	Arm Caps	Leg, Caster and Base	Tablet	Front Panel	Fabric 1
Standard X9 No Arms	Standard X9 No Arm Cap	Standard X9 Turned Satin Aluminum Legs	Standard X9 No Selection of Option	Standard X9 Two Upholstered Drawers	Selection Required
B9 Straight Arm (set of 2) (adds 5" to overall length) C1 Flared Arm (set of 2) (adds 7" to overall length) (see pricing below)	FIT Poly (black) \$206 FIU Wood (specify finish) \$181	L5 Brushed Chrome Leg M2 Wood Legs K8 Casters (set of 6) (3 locking) \$376 L8 Plynth Base \$305	FIM Left Side Facing (specify color) HPL \$561 , Veneer \$571 FIN Right Side Facing (specify color) HPL \$561 , Veneer \$571	L7 Drawerless (Solid Upholstered Front Panel) M1 Set of 2 Exposed Wood Veneer Drawer Fronts (specify finish) \$506 L6 Set of 2 TFL Drawer Fronts (specify finish) \$506	Fabric: Grade, Vendor, Pattern, Color NOTE: For multiple fabric applications see page 14 for information and pricing

Arm Style B9

yds com (54")	sq ft col	com 1	col 2	3	4	5	6	7	8	9	10	11	12	13	14	15	L1	L2	L3
2.5	n/a	367	408	455	514	596	714	831	949	1,066	1,184	1,302	1,419	1,537	1,654	1,772	882	1,001	1,117

Arm Style C1

yds com (54")	sq ft col	com 1	col 2	3	4	5	6	7	8	9	10	11	12	13	14	15	L1	L2	L3
2.5	n/a	372	413	460	519	601	719	836	954	1,071	1,189	1,307	1,424	1,542	1,659	1,777	887	1,006	1,122

HOW TO ORDER

SPECIFY: Arm styles | arm caps | arm cap finish (if applicable) | leg style | tablet | tablet finish (if applicable) | front panel | front panel finish (if applicable) | textile pattern and color. See pages 5-14 for information and options on moisture barrier, CAL133, upholstery applications, a complete offering of finishes and ordering details.

MODEL NUMBER

7058-S76

Arm Styles	Arm Caps	Leg, Caster and Base	Tablet	Front Panel	Fabric 1
B9	FIU - MLC	M2 - MLC	FIM - MLC	L7	Grade 5, Momentum, Row, Breeze

RETROSPECT SIDE SLEEPER STANDARD FEATURES

- Upholstered Arms, Seat, Back and Front Panel
- Semi-Attached Folding Back Cushion
- Tight Seat Cushion
- Beige Antimicrobial Sleep Surface
- 1625" x 1.375" Brushed Aluminum Leg
- Metal Trundle Cart on Casters
- Two Storage Cubbies inside Trundle
- Non-Marring Adjustable Glides
- 7" x 15" Veneer or HPL Tablet with Exposed Wood Edge and Satin Aluminum Finished Swivel Arm

**LEFT OPENING (7058-SSL)
RIGHT OPENING (7058-SSR)**

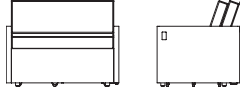

w	outside d	h	sw	seat sd	sh	seat to top of back	arm height	sleep surface length	weight lbs.	cubic feet
44	34	33.5	40	20	20	13	23.5	79.25	187	40

model	yds com (54")	sq ft col	com 1	col 2	3	4	5	6	7	8	9	10	11	12	13	14	15	L1	L2	L3
7058-SSL	7.75	n/a	3,849	3,977	4,122	4,305	4,560	4,924	5,288	5,653	6,017	6,382	6,746	7,111	7,475	7,840	8,204	5,388	5,755	6,116
7058-SSR																				

OPTIONS

Arm Caps	Caster	Tablet	Front Panel	Fabric 1
Standard X9 No Arm Cap	Standard X9 No Selection of Option	Standard X9 No Selection of Option	Standard H8 Upholstered Front Panel	Selection Required
A3 Wood (specify finish) \$163 pair A4 Poly (black) \$222 pair	K8 Non-Swivel Locking Casters (set of 4) \$285	FIM Left Side Facing (specify color) HPL \$561 , Veneer \$571 FIN Right Side Facing (specify color) HPL \$561 , Veneer \$571	H9 Exposed Wood (specify finish) \$208 B2W Exposed TFL (specify color) \$69	NOTE: For multiple fabric applications see page 14 for information and pricing

HOW TO ORDER

SPECIFY: Arm caps | arm cap finish (if applicable) | caster | tablet | tablet finish (if applicable) | front panel | front panel finish (if applicable) | textile pattern and color. See pages 5-14 for information and options on moisture barrier, CAL133, upholstery applications, a complete offering of finishes and ordering details.

MODEL NUMBER

7058-SSL

Arm Caps	Caster	Tablet	Front Panel	Fabric 1
A3 - MLC	K8	FIM - MLC	H9 - MLC	Grade 5, Momentum, Row, Breeze

REVERIE STRAIGHT ARM SLEEPERS WITH LEGS STANDARD FEATURES

- Upholstered Seat and Back
- Straight Upholstered Arm with European Beech Arm Cap
- Tight Cushion on Seat
- Back Cushion Semi-Attached, Movable with Mechanism
- Open under Seats
- 3/4" Thick Black Back Panel Located Between the Modesty and the Upholstered Back
- Black Antimicrobial Sleep Surface
- Warm Grey (with Silver Ion Antimicrobial) Powder Coat Legs with no Trim Detail between Front and Back Legs
- Non-Marring Adjustable Glides

68" SLEEPER

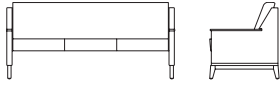

		outside			seat			seat to top	arm	sleep surface		weight	cubic
		w	d	h	sw	sd	sh	of back	height	w	d	lbs.	feet
		74	33.75	35.75	68.75	20	18.75	22	23.25	68	29	280	51

model	yds com (54")	sq ft col	com 1	col 2	3	4	5	6	7	8	9	10	11	12	13	14	15	L1	L2	L3
8058-68	9.25	n/a	4,399	4,551	4,725	4,943	5,247	5,682	6,117	6,552	6,987	7,422	7,857	8,292	8,727	9,162	9,597	6,230	6,669	7,099

72" SLEEPER

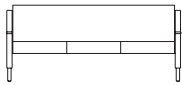

		outside			seat			seat to top	arm	sleep surface		weight	cubic
		w	d	h	sw	sd	sh	of back	height	w	d	lbs.	feet
		78	33.75	35.75	72.75	20	18.75	22	23.25	72	29	290	65

model	yds com (54")	sq ft col	com 1	col 2	3	4	5	6	7	8	9	10	11	12	13	14	15	L1	L2	L3
8058-72	9.5	n/a	4,488	4,644	4,823	5,046	5,359	5,806	6,253	6,699	7,146	7,593	8,039	8,486	8,933	9,380	9,826	6,368	6,818	7,261

OPTIONS

Seat	Arm Caps	Leg, Caster and Trim Detail	Powder Coated Leg and Trim	3DL Tablet with Spill Groove	3DL Center Table with Spill Groove	Removable Seat Covers	Under Seat Storage Shelf	Front Modesty Panel	Drawer Fronts	Fabric 1
Selection Required	Standard A3 Wood (specify finish)	Standard X9 Metal Leg / No Trim Detail	Standard H1F Warm Grey	Standard X9 No Selection of Option	Standard X9 No Selection of Option	Standard X9 No Selection of Option	Standard X9 No Selection of Option	Standard X9 No Selection of Option	Standard X9 No Selection of Option	Selection Required
B9E Solid Seat Cushion (not available with center table options) B9F Individual Seat Cushions	A4 Poly (black) \$275 pair Solid Surface CWS Cameo White MWS Modern White CSS Concrete DMS Deep Mink	K8 Locking Casters (set of 4) \$132 B7B Wood Trim Side Detail (specify finish) \$219 B7C Metal Trim Side Detail (specify color) \$330 NOTE: Trim Detail not available with K8 Casters	See page 9 for full list of powder coat options	F1M Left Side Facing (specify color) \$439 F1N Right Side Facing (specify color) \$439	B6X No Power Cut Out (specify color) \$247 B6Y With Power Cut Out (specify color) \$330 NOTE: To order Power Supply Unit see page 243	B1L Removable Seat Cover \$330	B2T Wood Veneer (specify finish) \$330 B7F TFL (specify color) \$330	B7D Wood Veneer (specify finish) \$330 B6Z 3DL (specify color) \$330 B7A Upholstered (see pricing below)	B9D Wood Veneer (specify finish) \$1,109 B9C 3DL (specify color) \$1,156 B8M Upholstered (see pricing below)	Fabric: Grade, Vendor, Pattern, Color NOTE: For multiple fabric applications see page 14 for information and pricing

Front Modesty Panel Options

yds com (54")	sq ft col	com 1	col 2	3	4	5	6	7	8	9	10	11	12	13	14	15	L1	L2	L3
2.5	n/a	375	416	463	522	604	722	839	957	1,074	1,192	1,310	1,427	1,545	1,662	1,780	890	1,009	1,125

Drawer Front Options

yds com (54")	sq ft col	com 1	col 2	3	4	5	6	7	8	9	10	11	12	13	14	15	L1	L2	L3
1.5	n/a	946	971	999	1,034	1,084	1,154	1,225	1,295	1,366	1,436	1,507	1,577	1,648	1,718	1,789	1,266	1,338	1,407

HOW TO ORDER

SPECIFY: Seat | arm caps | arm cap finish (if applicable) | leg and caster | wood trim finish (if applicable) | powder coat | tablet | tablet finish (if applicable) | center table | center table finish (if applicable) | removable covers | storage shelf | storage shelf finish (if applicable) | modesty | modesty finish (if applicable) | drawers | drawer finish (if applicable) | textile pattern and color. See pages 5-14 for information and options on moisture barrier, CAL133, upholstery applications, a complete offering of finishes and ordering details.

MODEL NUMBER

8058-68

Seat	Arm Caps	Leg, Caster and Trim Detail	Powder Coated Leg and Trim	3DL Tablet with Spill Groove	3DL Center Table with Spill Groove	Removable Seat Covers	Under Seat Storage Shelf	Front Modesty Panel	Drawer Fronts	Fabric 1
B9F	A3 - MHM	K8	X9	F1M - MH3	B6X - MH3	B1L	X9	X9	B9D - MHM	Grade 5, Momentum, Row, Breeze

REVERIE STRAIGHT ARM SLEEPERS WITH LEGS STANDARD FEATURES

- Upholstered Seat and Back
- Straight Upholstered Arm with European Beech Arm Cap
- Tight Cushion on Seat
- Back Cushion Semi-Attached, Movable with Mechanism
- Open under Seats
- 3/4" Thick Black Back Panel Located Between the Modesty and the Upholstered Back
- Black Antimicrobial Sleep Surface
- Warm Grey (with Silver Ion Antimicrobial) Powder Coat Legs with no Trim Detail between Front and Back Legs
- Non-Marring Adjustable Glides

76" SLEEPER

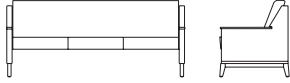

outside			seat			seat to top	arm	sleep surface		weight	cubic
w	d	h	sw	sd	sh	of back	height	w	d	lbs.	feet
82	33.75	35.75	76.75	20	18.75	22	23.25	76	29	300	57

model	yds com (54")	sq ft col	com 1	col 2	3	4	5	6	7	8	9	10	11	12	13	14	15	L1	L2	L3
8058-76	9.75	n/a	4,627	4,787	4,971	5,200	5,521	5,980	6,438	6,896	7,355	7,813	8,272	8,730	9,189	9,647	10,106	6,556	7,018	7,472

80" SLEEPER

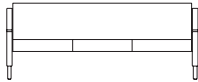

outside			seat			seat to top	arm	sleep surface		weight	cubic
w	d	h	sw	sd	sh	of back	height	w	d	lbs.	feet
86	33.75	35.75	80.75	20	18.75	22	23.25	80	29	310	60

model	yds com (54")	sq ft col	com 1	col 2	3	4	5	6	7	8	9	10	11	12	13	14	15	L1	L2	L3
8058-80	10	n/a	4,658	4,823	5,011	5,246	5,575	6,045	6,515	6,986	7,456	7,926	8,396	8,867	9,337	9,807	10,277	6,636	7,110	7,575

OPTIONS

Seat	Arm Caps	Leg, Caster and Trim Detail	Powder Coated Leg and Trim	3DL Tablet with Spill Groove	3DL Center Table with Spill Groove	Removable Seat Covers	Under Seat Storage Shelf	Front Modesty Panel	Drawer Fronts	Fabric 1
Selection Required	Standard A3 Wood (specify finish)	Standard X9 Metal Leg / No Trim Detail	Standard H1F Warm Grey	Standard X9 No Selection of Option	Standard X9 No Selection of Option	Standard X9 No Selection of Option	Standard X9 No Selection of Option	Standard X9 No Selection of Option	Standard X9 No Selection of Option	Selection Required
B9E Solid Seat Cushion (not available with center table options) B9F Individual Seat Cushions	A4 Poly (black) \$275 pair Solid Surface CWS Cameo White MWS Modern White CSS Concrete DMS Deep Mink	K8 Locking Casters (set of 4) \$132 B7B Wood Trim Side Detail (specify finish) \$219 B7C Metal Trim Side Detail (specify color) \$330 NOTE: Trim Detail not available with K8 Casters	See page 9 for full list of powder coat options	F1M Left Side Facing (specify color) \$439 F1N Right Side Facing (specify color) \$439	B6X No Power Cut Out (specify color) \$247 B6Y With Power Cut Out (specify color) \$330 NOTE: To order Power Supply Unit see page 243	B1L Removable Seat Cover \$330	B2T Wood Veneer (specify finish) \$330 B7F TFL (specify color) \$330	B7D Wood Veneer (specify finish) \$330 B6Z 3DL (specify color) \$330 B7A Upholstered (see pricing below)	B9D Wood Veneer (specify finish) \$1,109 B9C 3DL (specify color) \$1,156 B8M Upholstered (see pricing below)	Fabric: Grade, Vendor, Pattern, Color NOTE: For multiple fabric applications see page 14 for information and pricing

Front Modesty Panel Options

yds com (54")	sq ft col	com 1	col 2	3	4	5	6	7	8	9	10	11	12	13	14	15	L1	L2	L3
2.5	n/a	375	416	463	522	604	722	839	957	1,074	1,192	1,310	1,427	1,545	1,662	1,780	890	1,009	1,125

Drawer Front Options

yds com (54")	sq ft col	com 1	col 2	3	4	5	6	7	8	9	10	11	12	13	14	15	L1	L2	L3
1.5	n/a	946	971	999	1,034	1,084	1,154	1,225	1,295	1,366	1,436	1,507	1,577	1,648	1,718	1,789	1,266	1,338	1,407

HOW TO ORDER

SPECIFY: Seat | arm caps | arm cap finish (if applicable) | leg and caster | wood trim finish (if applicable) | powder coat | tablet | tablet finish (if applicable) | center table | center table finish (if applicable) | removable covers | storage shelf | storage shelf finish (if applicable) | modesty | modesty finish (if applicable) | drawers | drawer finish (if applicable) | textile pattern and color. See pages 5-14 for information and options on moisture barrier, CAL133, upholstery applications, a complete offering of finishes and ordering details.

MODEL NUMBER

8058-76

Seat	Arm Caps	Leg, Caster and Trim Detail	Powder Coated Leg and Trim	3DL Tablet with Spill Groove	3DL Center Table with Spill Groove	Removable Seat Covers	Under Seat Storage Shelf	Front Modesty Panel	Drawer Fronts	Fabric 1
B9F	A3 - MHM	K8	X9	F1M - MH3	B6X - MH3	B1L	X9	X9	B9D - MHM	Grade 5, Momentum, Row, Breeze

REVERIE MAZE ARM SLEEPERS STANDARD FEATURES

- Upholstered Seat and Back
- Tight Cushion on Seat
- Back Cushion Semi-Attached, Movable with Mechanism
- Open under Seats
- 3/4" Thick Black Back Panel Located Between the Modesty and the Upholstered Back
- Warm Grey (with Silver Ion Antimicrobial) Powder Coated Leg and Arm Frame with European Beech Arm Cap
- Wall-Saver Design
- Black Antimicrobial Sleep Surface
- Non-Marring Adjustable Glides

68" MAZE ARM SLEEPER

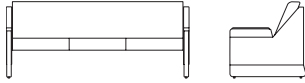

outside			seat			seat to top		arm		sleep surface		weight		cubic	
w	d	h	sw	sd	sh	of back		height		w	d	lbs.	feet		
73.75	34.25	35.75	68.75	20	18.75	22		23.5		68	29	280	52		

model	yds com (54")	sq ft col	com 1	col 2	3	4	5	6	7	8	9	10	11	12	13	14	15	L1	L2	L3
8059-68	9.25	n/a	5,038	5,190	5,364	5,582	5,886	6,321	6,756	7,191	7,626	8,061	8,496	8,931	9,366	9,801	10,236	6,869	7,308	7,738

72" MAZE ARM SLEEPER

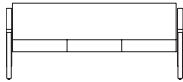

outside			seat			seat to top		arm		sleep surface		weight		cubic	
w	d	h	sw	sd	sh	of back		height		w	d	lbs.	feet		
77.75	34.25	35.75	72.75	20	18.75	22		23.5		72	29	290	55		

model	yds com (54")	sq ft col	com 1	col 2	3	4	5	6	7	8	9	10	11	12	13	14	15	L1	L2	L3
8059-72	9.5	n/a	5,094	5,250	5,429	5,652	5,965	6,412	6,859	7,305	7,752	8,199	8,645	9,092	9,539	9,986	10,432	6,974	7,424	7,867

OPTIONS

Seat	Arm Caps	Powder Coated Leg Colors	3DL Center Table with Spill Groove	Removable Seat Covers	Under Seat Storage Shelf	Front Modesty Panel	Drawer Fronts	Fabric 1
Selection Required	Standard A3 Wood (specify finish)	Standard H1F Warm Grey	Standard X9 No Selection of Option	Standard X9 No Selection of Option	Standard X9 No Selection of Option	Standard X9 No Selection of Option	Standard X9 No Selection of Option	Selection Required
B9E Solid Seat Cushion (not available with center table options) B9F Individual Seat Cushions	A4 Poly (black) \$275 pair Solid Surface \$143 pair CWS Cameo White MWS Modern White CSS Concrete DMS Deep Mink	See page 9 for full list of powder coat options	B6X No Power Cut Out (specify color) \$247 B6Y With Power Cut Out (specify color) \$330 NOTE: To order Power Supply Unit see page 243	B1L Removable Seat Cover \$330	B2T Wood Veneer (specify finish) \$330 B7F TFL (specify color) \$330	B7D Wood Veneer (specify finish) \$330 B6Z 3DL (specify color) \$330 B7A Upholstered (see pricing below)	B9D Wood Veneer (specify finish) \$1,072 B9C 3DL (specify color) \$1,117 B8M Upholstered (see pricing below)	Fabric: Grade, Vendor, Pattern, Color NOTE: For multiple fabric applications see page 14 for information and pricing

Front Modesty Panel Options

yds com (54")	sq ft col	com 1	col 2	3	4	5	6	7	8	9	10	11	12	13	14	15	L1	L2	L3
2.5	n/a	375	416	463	522	604	722	839	957	1,074	1,192	1,310	1,427	1,545	1,662	1,780	890	1,009	1,125

Drawer Front Options

yds com (54")	sq ft col	com 1	col 2	3	4	5	6	7	8	9	10	11	12	13	14	15	L1	L2	L3
1.5	n/a	946	971	999	1,034	1,084	1,154	1,225	1,295	1,366	1,436	1,507	1,577	1,648	1,718	1,789	1,266	1,338	1,407

HOW TO ORDER

SPECIFY: Seat | arm caps | arm cap finish (if applicable) | powder coat | center table | center table finish (if applicable) | removable covers | storage shelf | storage shelf finish (if applicable) | modesty | modesty finish (if applicable) | drawers | drawer finish (if applicable) | textile pattern and color. See pages 5-14 for information and options on moisture barrier, CAL133, upholstery applications, a complete offering of finishes and ordering details.

MODEL NUMBER

8059-68

Seat	Arm Caps	Powder Coated Leg Colors	3DL Center Table with Spill Groove	Removable Seat Covers	Under Seat Storage Shelf	Front Modesty Panel	Drawer Fronts	Fabric 1
B9F	A3 - MHM	H1F	B6X - MH3	B1L	X9	X9	B9D - MHM	Grade 5, Momentum, Row, Breeze

REVERIE MAZE ARM SLEEPERS STANDARD FEATURES

- Upholstered Seat and Back
- Tight Cushion on Seat
- Back Cushion Semi-Attached, Movable with Mechanism
- Open under Seats
- 3/4" Thick Black Back Panel Located Between the Modesty and the Upholstered Back
- Warm Grey (with Silver Ion Antimicrobial) Powder Coated Leg and Arm Frame with European Beech Arm Cap
- Wall-Saver Design
- Black Antimicrobial Sleep Surface
- Non-Marring Adjustable Glides

76" MAZE ARM SLEEPER

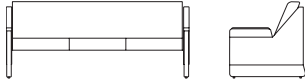

outside			seat			seat to top		sleep surface		weight		cubic	
w	d	h	sw	sd	sh	of back		height		w	d	lbs.	feet
81.75	34.25	35.75	76.75	20	18.75	22		23.5		76	29	300	58

model	yds com (54")	sq ft col	com 1	col 2	3	4	5	6	7	8	9	10	11	12	13	14	15	L1	L2	L3
8059-76	9.75	n/a	5,165	5,325	5,509	5,738	6,059	6,518	6,976	7,434	7,893	8,351	8,810	9,268	9,727	10,185	10,644	7,094	7,556	8,010

80" MAZE ARM SLEEPER

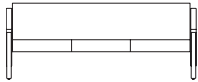

outside			seat			seat to top		sleep surface		weight		cubic	
w	d	h	sw	sd	sh	of back		height		w	d	lbs.	feet
85.75	34.25	35.75	80.75	20	18.75	22		23.5		80	29	310	61

model	yds com (54")	sq ft col	com 1	col 2	3	4	5	6	7	8	9	10	11	12	13	14	15	L1	L2	L3
8059-80	10	n/a	5,259	5,424	5,612	5,847	6,176	6,646	7,116	7,587	8,057	8,527	8,997	9,468	9,938	10,408	10,878	7,237	7,711	8,176

OPTIONS

Seat	Arm Caps	Powder Coated Leg Colors	3DL Center Table with Spill Groove	Removable Seat Covers	Under Seat Storage Shelf	Front Modesty Panel	Drawer Fronts	Fabric 1
Selection Required	Standard A3 Wood (specify finish)	Standard H1F Warm Grey	Standard X9 No Selection of Option	Standard X9 No Selection of Option	Standard X9 No Selection of Option	Standard X9 No Selection of Option	Standard X9 No Selection of Option	Selection Required
B9E Solid Seat Cushion (not available with center table options)	A4 Poly (black) \$275 pair	See page 9 for full list of powder coat options	B6X No Power Cut Out (specify color) \$247	B1L Removable Seat Cover \$330	B2T Wood Veneer (specify finish) \$330	B7D Wood Veneer (specify finish) \$330	B9D Wood Veneer (specify finish) \$1,072	Fabric: Grade, Vendor, Pattern, Color NOTE: For multiple fabric applications see page 14 for information and pricing
B9F Individual Seat Cushions	Solid Surface \$143 pair		B6Y With Power Cut Out (specify color) \$330		B7F TFL (specify color) \$330	B6Z 3DL (specify color) \$330	B9C 3DL (specify color) \$1,117	
	CWS Cameo White MWS Modern White CSS Concrete DMS Deep Mink		NOTE: To order Power Supply Unit see page 243			B7A Upholstered (see pricing below)	B8M Upholstered (see pricing below)	

Front Modesty Panel Options

yds com (54")	sq ft col	com 1	col 2	3	4	5	6	7	8	9	10	11	12	13	14	15	L1	L2	L3
2.5	n/a	375	416	463	522	604	722	839	957	1,074	1,192	1,310	1,427	1,545	1,662	1,780	890	1,009	1,125

Drawer Front Options

yds com (54")	sq ft col	com 1	col 2	3	4	5	6	7	8	9	10	11	12	13	14	15	L1	L2	L3
1.5	n/a	946	971	999	1,034	1,084	1,154	1,225	1,295	1,366	1,436	1,507	1,577	1,648	1,718	1,789	1,266	1,338	1,407

HOW TO ORDER

SPECIFY: Seat | arm caps | arm cap finish (if applicable) | powder coat | center table | center table finish (if applicable) | removable covers | storage shelf | storage shelf finish (if applicable) | modesty | modesty finish (if applicable) | drawers | drawer finish (if applicable) | textile pattern and color. See pages 5-14 for information and options on moisture barrier, CAL133, upholstery applications, a complete offering of finishes and ordering details.

MODEL NUMBER

8059-76

Seat	Arm Caps	Powder Coated Leg Colors	3DL Center Table with Spill Groove	Removable Seat Covers	Under Seat Storage Shelf	Front Modesty Panel	Drawer Fronts	Fabric 1
B9F	A3 - MHM	H1F	B6X - MH3	B1L	X9	X9	B9D - MHM	Grade 5, Momentum, Row, Breeze

REVERIE BOX ARM SLEEPERS STANDARD FEATURES

- Upholstered Seat and Back
- Tight Cushion on Seat
- Back Cushion Semi-Attached, Movable with Mechanism
- Open under Seats
- 3/4" Thick Black Back Panel Located Between the Modesty and the Upholstered Back
- 9" wide Upholstered Arm with Upholstered Arm Cap
- Adds 18" to Sleep Surface Length
- Black Antimicrobial Sleep Surface
- Warm Grey (with Silver Ion Antimicrobial) Powder Coated Legs
- Non-Marring Adjustable Glides

68" BOX ARM SLEEPER

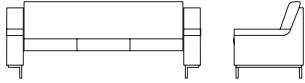

		outside			seat			seat to top	arm	sleep surface		weight	cubic
		w	d	h	sw	sd	sh	of back	height	w	d	lbs.	feet
		85.75	33.25	35.75	68.75	20	18.75	22	23	68	29	280	59

model	yds com (54")	sq ft col	com 1	col 2	3	4	5	6	7	8	9	10	11	12	13	14	15	L1	L2	L3
8060-68	9.75	n/a	4,640	4,800	4,984	5,213	5,534	5,993	6,451	6,909	7,368	7,826	8,285	8,743	9,202	9,660	10,119	6,569	7,031	7,485

72" BOX ARM SLEEPER

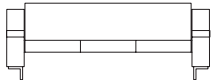

		outside			seat			seat to top	arm	sleep surface		weight	cubic
		w	d	h	sw	sd	sh	of back	height	w	d	lbs.	feet
		89.75	33.25	35.75	72.75	20	18.75	22	23	72	29	290	61

model	yds com (54")	sq ft col	com 1	col 2	3	4	5	6	7	8	9	10	11	12	13	14	15	L1	L2	L3
8060-72	10	n/a	4,665	4,830	5,018	5,253	5,582	6,052	6,522	6,993	7,463	7,933	8,403	8,874	9,344	9,814	10,284	6,643	7,117	7,582

OPTIONS

Seat	Arm Caps	Caster	Powder Coated Leg Colors	3DL Tablet with Spill Groove	3DL Center Table with Spill Groove	Removable Seat Covers	Under Seat Storage Shelf	Front Modesty Panel	Drawer Fronts	Fabric 1
Selection Required	Standard X9 Upholstered	Standard X9 No Selection of Option	Standard HIF Warm Grey	Standard X9 No Selection of Option	Standard X9 No Selection of Option	Standard X9 No Selection of Option	Standard X9 No Selection of Option	Standard X9 No Selection of Option	Standard X9 No Selection of Option	Selection Required
B9E Solid Seat Cushion (not available with center table options) B9F Individual Seat Cushions	Solid Surface \$659 pair CWS Cameo White MWS Modern White CSS Concrete DMS Deep Mink	K8 Locking Casters (set of 4) \$132	See page 9 for full list of powder coat options	FIM Left Side Facing (specify color) \$439 FIN Right Side Facing (specify color) \$439	B6X No Power Cut Out (specify color) \$247 B6Y With Power Cut Out (specify color) \$330 NOTE: To order Power Supply Unit see page 243	B1L Removable Seat Cover \$330	B2T Wood Veneer (specify finish) \$330 B7F TFL (specify color) \$330	B7D Wood Veneer (specify finish) \$330 B6Z 3DL (specify color) \$330 B7A Upholstered (see pricing below)	B9D Wood Veneer (specify finish) \$1,109 B9C 3DL (specify color) \$1,156 B8M Upholstered (see pricing below)	Fabric: Grade, Vendor, Pattern, Color NOTE: For multiple fabric applications see page 14 for information and pricing

Front Modesty Panel Options

yds com (54")	sq ft col	com 1	col 2	3	4	5	6	7	8	9	10	11	12	13	14	15	L1	L2	L3
2.5	n/a	375	416	463	522	604	722	839	957	1,074	1,192	1,310	1,427	1,545	1,662	1,780	890	1,009	1,125

Drawer Front Options

yds com (54")	sq ft col	com 1	col 2	3	4	5	6	7	8	9	10	11	12	13	14	15	L1	L2	L3
1.5	n/a	946	971	999	1,034	1,084	1,154	1,225	1,295	1,366	1,436	1,507	1,577	1,648	1,718	1,789	1,266	1,338	1,407

HOW TO ORDER

SPECIFY: Seat | arm caps | caster | powder coat | tablet | tablet finish (if applicable) | center table | center table finish (if applicable) | removable covers | storage shelf | storage shelf finish (if applicable) | modesty | modesty finish (if applicable) | drawers | drawer finish (if applicable) | textile pattern and color. See pages 5-14 for information and options on moisture barrier, CAL133, upholstery applications, a complete offering of finishes and ordering details.

MODEL NUMBER

8060-68

Seat	Arm Caps	Caster	Powder Coated Leg Colors	3DL Tablet with Spill Groove	3DL Center Table with Spill Groove	Removable Seat Covers	Under Seat Storage Shelf	Front Modesty Panel	Drawer Fronts	Fabric 1
B9F	GLW	X9	HIF	FIM - MH3	B6X - MH3	B1L	X9	X9	B9D - MHM	Grade 5, Momentum, Row, Breeze

REVERIE BOX ARM SLEEPERS STANDARD FEATURES

- Upholstered Seat and Back
- Tight Cushion on Seat
- Back Cushion Semi-Attached, Movable with Mechanism
- Open under Seats
- 3/4" Thick Black Back Panel Located Between the Modesty and the Upholstered Back
- 9" wide Upholstered Arm with Upholstered Arm Cap
- Adds 18" to Sleep Surface Length
- Black Antimicrobial Sleep Surface
- Warm Grey (with Silver Ion Antimicrobial) Powder Coated Legs
- Non-Marring Adjustable Glides

76" BOX ARM SLEEPER

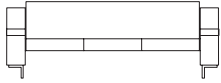

		outside			seat			seat to top	arm	sleep surface		weight	cubic
		w	d	h	sw	sd	sh	of back	height	w	d	lbs.	feet
		93.75	33.25	35.75	76.75	20	18.75	22	23	76	29	300	64

model	yds com (54")	sq ft col	com 1	col 2	3	4	5	6	7	8	9	10	11	12	13	14	15	L1	L2	L3
8060-76	10.25	n/a	4,805	4,974	5,166	5,407	5,745	6,227	6,709	7,191	7,673	8,155	8,637	9,119	9,601	10,083	10,565	6,831	7,317	7,794

80" BOX ARM SLEEPER

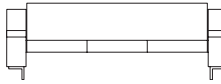

		outside			seat			seat to top	arm	sleep surface		weight	cubic
		w	d	h	sw	sd	sh	of back	height	w	d	lbs.	feet
		97.75	33.25	35.75	80.75	20	18.75	22	23	80	29	310	67

model	yds com (54")	sq ft col	com 1	col 2	3	4	5	6	7	8	9	10	11	12	13	14	15	L1	L2	L3
8060-80	10.5	n/a	4,859	5,032	5,229	5,476	5,822	6,316	6,809	7,303	7,797	8,291	8,784	9,278	9,772	10,265	10,759	6,934	7,432	7,921

OPTIONS

Seat	Arm Caps	Caster	Powder Coated Leg Colors	3DL Tablet with Spill Groove	3DL Center Table with Spill Groove	Removable Seat Covers	Under Seat Storage Shelf	Front Modesty Panel	Drawer Fronts	Fabric 1
Selection Required	Standard X9 Upholstered	Standard X9 No Selection of Option	Standard HIF Warm Grey	Standard X9 No Selection of Option	Standard X9 No Selection of Option	Standard X9 No Selection of Option	Standard X9 No Selection of Option	Standard X9 No Selection of Option	Standard X9 No Selection of Option	Standard X9 No Selection of Option
B9E Solid Seat Cushion (not available with center table options) B9F Individual Seat Cushions	Solid Surface \$659 pair CWS Cameo White MWS Modern White CSS Concrete DMS Deep Mink	K8 Locking Casters (set of 4) \$132	See page 9 for full list of powder coat options	FIM Left Side Facing (specify color) \$439 FIN Right Side Facing (specify color) \$439	B6X No Power Cut Out (specify color) \$247 B6Y With Power Cut Out (specify color) \$330 NOTE: To order Power Supply Unit see page 243	B1L Removable Seat Cover \$330	B2T Wood Veneer (specify finish) \$330 B7F TFL (specify color) \$330	B7D Wood Veneer (specify finish) \$330 B6Z 3DL (specify color) \$330 B7A Upholstered (see pricing below)	B9D Wood Veneer (specify finish) \$1,109 B9C 3DL (specify color) \$1,156 B8M Upholstered (see pricing below)	Fabric: Grade, Vendor, Pattern, Color NOTE: For multiple fabric applications see page 14 for information and pricing

Front Modesty Panel Options

yds com (54")	sq ft col	com 1	col 2	3	4	5	6	7	8	9	10	11	12	13	14	15	L1	L2	L3
2.5	n/a	375	416	463	522	604	722	839	957	1,074	1,192	1,310	1,427	1,545	1,662	1,780	890	1,009	1,125

Drawer Front Options

yds com (54")	sq ft col	com 1	col 2	3	4	5	6	7	8	9	10	11	12	13	14	15	L1	L2	L3
1.5	n/a	946	971	999	1,034	1,084	1,154	1,225	1,295	1,366	1,436	1,507	1,577	1,648	1,718	1,789	1,266	1,338	1,407

HOW TO ORDER

SPECIFY: Seat | arm caps | caster | powder coat | tablet | tablet finish (if applicable) | center table | center table finish (if applicable) | removable covers | storage shelf | storage shelf finish (if applicable) | modesty | modesty finish (if applicable) | drawers | drawer finish (if applicable) | textile pattern and color. See pages 5-14 for information and options on moisture barrier, CAL133, upholstery applications, a complete offering of finishes and ordering details.

MODEL NUMBER

8060-76

Seat	Arm Caps	Caster	Powder Coated Leg Colors	3DL Tablet with Spill Groove	3DL Center Table with Spill Groove	Removable Seat Covers	Under Seat Storage Shelf	Front Modesty Panel	Drawer Fronts	Fabric 1
B9F	GLW	X9	HIF	FIM - MH3	B6X - MH3	B1L	X9	X9	B9D - MHM	Grade 5, Momentum, Row, Breeze

REVERIE FLOOR LENGTH STRAIGHT ARM SLEEPERS STANDARD FEATURES

- Upholstered Seat and Back
- Tight Cushion on Seat
- Back Cushion Semi-Attached, Movable with Mechanism
- Open under Seats
- 3/4" Thick Black Back Panel Located Between the Modesty and the Upholstered Back
- Fully Upholstered Arm Panel with European Beech Arm Cap
- Black Antimicrobial Sleep Surface
- Aluminum Legs
- Non-Marring Adjustable Glides

68" FLOOR LENGTH STRAIGHT ARM SLEEPER

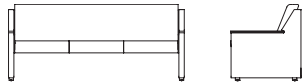

model	yds com (54")	sq ft col	com 1	outside			seat			seat to top of back	arm height	sleep surface		weight			cubic feet			
				w	d	h	sw	sd	sh			w	d	lbs.	L1	L2		L3		
8061-68	9.5	n/a	4,328	4,484	4,663	4,886	5,199	5,646	6,093	6,539	6,986	7,433	7,879	8,326	8,773	9,220	9,666	6,208	6,658	7,101

72" FLOOR LENGTH STRAIGHT ARM SLEEPER

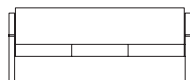

model	yds com (54")	sq ft col	com 1	outside			seat			seat to top of back	arm height	sleep surface		weight			cubic feet			
				w	d	h	sw	sd	sh			w	d	lbs.	L1	L2		L3		
8061-72	9.75	n/a	4,378	4,538	4,722	4,951	5,272	5,731	6,189	6,647	7,106	7,564	8,023	8,481	8,940	9,398	9,857	6,307	6,769	7,223

OPTIONS

Seat	Arm Caps	3DL Tablet with Spill Groove	3DL Center Table with Spill Groove	Removable Seat Covers	Under Seat Storage Shelf	Front Modesty Panel	Drawer Fronts	Fabric 1
Selection Required	Standard A3 Wood (specify finish)	Standard X9 No Selection of Option	Standard X9 No Selection of Option	Standard X9 No Selection of Option	Standard X9 No Selection of Option	Standard X9 No Selection of Option	Standard X9 No Selection of Option	Selection Required
B9E Solid Seat Cushion (not available with center table options) B9F Individual Seat Cushions	A4 Poly (black) \$275 pair Solid Surface \$296 pair CWS Cameo White MWS Modern White CSS Concrete DMS Deep Mink	F1M Left Side Facing (specify color) \$439 F1N Right Side Facing (specify color) \$439	B6X No Power Cut Out (specify color) \$247 B6Y With Power Cut Out (specify color) \$330 NOTE: To order Power Supply Unit see page 243	B1L Removable Seat Cover \$330	B2T Wood Veneer (specify finish) \$330 B7F TFL (specify color) \$330	B7D Wood Veneer (specify finish) \$330 B6Z 3DL (specify color) \$330 B7A Upholstered (see pricing below)	B9D Wood Veneer (specify finish) \$1,109 B9C 3DL (specify color) \$1,156 B8M Upholstered (see pricing below)	Fabric: Grade, Vendor, Pattern, Color NOTE: For multiple fabric applications see page 14 for information and pricing

Front Modesty Panel Options

yds com (54")	sq ft col	com 1	col 2	3	4	5	6	7	8	9	10	11	12	13	14	15	L1	L2	L3
2.5	n/a	375	416	463	522	604	722	839	957	1,074	1,192	1,310	1,427	1,545	1,662	1,780	890	1,009	1,125

Drawer Front Options

yds com (54")	sq ft col	com 1	col 2	3	4	5	6	7	8	9	10	11	12	13	14	15	L1	L2	L3
1.5	n/a	946	971	999	1,034	1,084	1,154	1,225	1,295	1,366	1,436	1,507	1,577	1,648	1,718	1,789	1,266	1,338	1,407

HOW TO ORDER

SPECIFY: Seat | arm caps | arm cap finish (if applicable) | tablet | tablet finish (if applicable) | center table | center table finish (if applicable) | removable covers | storage shelf | storage shelf finish (if applicable) | modesty | modesty finish (if applicable) | drawers | drawer finish (if applicable) | textile pattern and color. See pages 5-14 for information and options on moisture barrier, CAL133, upholstery applications, a complete offering of finishes and ordering details.

MODEL NUMBER

8061-68

Seat	Arm Caps	3DL Tablet with Spill Groove	3DL Center Table with Spill Groove	Removable Seat Covers	Under Seat Storage Shelf	Front Modesty Panel	Drawer Fronts	Fabric 1
B9F	A3 - MHM	F1M - MH3	B6X - MH3	B1L	X9	X9	B9D - MHM	Grade 5, Momentum, Row, Breeze

REVERIE FLOOR LENGTH STRAIGHT ARM SLEEPERS STANDARD FEATURES

- Upholstered Seat and Back
- Tight Cushion on Seat
- Back Cushion Semi-Attached, Movable with Mechanism
- Open under Seats
- 3/4" Thick Black Back Panel Located Between the Modesty and the Upholstered Back
- Fully Upholstered Arm Panel with European Beech Arm Cap
- Black Antimicrobial Sleep Surface
- Aluminum Legs
- Non-Marring Adjustable Glides

76" FLOOR LENGTH STRAIGHT ARM SLEEPER

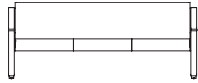

outside			seat			seat to top	arm	sleep surface		weight	cubic
w	d	h	sw	sd	sh	of back	height	w	d	lbs.	feet
82	33.25	35.75	76.75	20	18.75	22	23.25	76	29	300	56

model	yds com (54")	sq ft col	com 1	col 2	3	4	5	6	7	8	9	10	11	12	13	14	15	L1	L2	L3
8061-76	10	n/a	4,445	4,610	4,798	5,033	5,362	5,832	6,302	6,773	7,243	7,713	8,183	8,654	9,124	9,594	10,064	6,423	6,897	7,362

80" FLOOR LENGTH STRAIGHT ARM SLEEPER

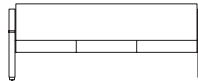

outside			seat			seat to top	arm	sleep surface		weight	cubic
w	d	h	sw	sd	sh	of back	height	w	d	lbs.	feet
86	33.25	35.75	80.75	20	18.75	22	23.25	80	29	310	59

model	yds com (54")	sq ft col	com 1	col 2	3	4	5	6	7	8	9	10	11	12	13	14	15	L1	L2	L3
8061-80	10.25	n/a	4,547	4,716	4,908	5,149	5,487	5,969	6,451	6,933	7,415	7,897	8,379	8,861	9,343	9,825	10,307	6,573	7,059	7,536

OPTIONS

Seat	Arm Caps	3DL Tablet with Spill Groove	3DL Center Table with Spill Groove	Removable Seat Covers	Under Seat Storage Shelf	Front Modesty Panel	Drawer Fronts	Fabric 1
Selection Required	Standard A3 Wood (specify finish)	Standard X9 No Selection of Option	Standard X9 No Selection of Option	Standard X9 No Selection of Option	Standard X9 No Selection of Option	Standard X9 No Selection of Option	Standard X9 No Selection of Option	Selection Required
B9E Solid Seat Cushion (not available with center table options) B9F Individual Seat Cushions	A4 Poly (black) \$275 pair Solid Surface \$296 pair CWS Cameo White MWS Modern White CSS Concrete DMS Deep Mink	F1M Left Side Facing (specify color) \$439 F1N Right Side Facing (specify color) \$439	B6X No Power Cut Out (specify color) \$247 B6Y With Power Cut Out (specify color) \$330 NOTE: To order Power Supply Unit see page 243	B1L Removable Seat Cover \$330	B2T Wood Veneer (specify finish) \$330 B7F TFL (specify color) \$330	B7D Wood Veneer (specify finish) \$330 B6Z 3DL (specify color) \$330 B7A Upholstered (see pricing below)	B9D Wood Veneer (specify finish) \$1,109 B9C 3DL (specify color) \$1,156 B8M Upholstered (see pricing below)	Fabric: Grade, Vendor, Pattern, Color NOTE: For multiple fabric applications see page 14 for information and pricing

Front Modesty Panel Options

yds com (54")	sq ft col	com 1	col 2	3	4	5	6	7	8	9	10	11	12	13	14	15	L1	L2	L3
2.5	n/a	375	416	463	522	604	722	839	957	1,074	1,192	1,310	1,427	1,545	1,662	1,780	890	1,009	1,125

Drawer Front Options

yds com (54")	sq ft col	com 1	col 2	3	4	5	6	7	8	9	10	11	12	13	14	15	L1	L2	L3
1.5	n/a	946	971	999	1,034	1,084	1,154	1,225	1,295	1,366	1,436	1,507	1,577	1,648	1,718	1,789	1,266	1,338	1,407

HOW TO ORDER

SPECIFY: Seat | arm caps | arm cap finish (if applicable) | tablet | tablet finish (if applicable) | center table | center table finish (if applicable) | removable covers | storage shelf | storage shelf finish (if applicable) | modesty | modesty finish (if applicable) | drawers | drawer finish (if applicable) | textile pattern and color. See **pages 5-14** for information and options on moisture barrier, CAL133, upholstery applications, a complete offering of finishes and ordering details.

MODEL NUMBER

8061-76

Seat	Arm Caps	3DL Tablet with Spill Groove	3DL Center Table with Spill Groove	Removable Seat Covers	Under Seat Storage Shelf	Front Modesty Panel	Drawer Fronts	Fabric 1
B9F	A3 - MHM	F1M - MH3	B6X - MH3	B1L	X9	X9	B9D - MHM	Grade 5, Momentum, Row, Breeze

POWER SUPPLY STANDARD FEATURES

- Two 10 Amp Electrical Outlets
- 6' Power Cord
- Anodized Aluminum Finish
- UL Listed
- NOTE: Power Supplies must be ordered separately from Sleepers

POWER SUPPLY

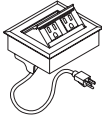

model		w	d	h	wt	cu ft	list
PS-67S	SILVER	5.1	4.4	3.25	2	0.25	\$ 181
PS-67B	BLACK	5.1	4.4	3.25	2	0.25	\$ 181

HOW TO ORDER

MODEL NUMBER

PS-67S

WHISPER SLEEPOVER BENCH STANDARD FEATURES

- Upholstered Seat and Trundle Front
- Semi-Attached Folding Cushion
- Storage Located Inside Trundle
- Memory Foam Sleep Cushions
- Black Antimicrobial, Sure-Chek® on Sleep Surface
- Non-Marring Adjustable Glides

68" SLEEPOVER BENCH

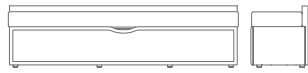

outside			seat			seat to top	arm	sleep surface		weight	cubic feet
w	d	h	sw	sd	sh	of back	height	w	d	lbs.	
68	19	20.5	68	17	18.5	n/a	n/a	68	37	175	22

model	yds com (54")	sq ft col	com 1	col 2	3	4	5	6	7	8	9	10	11	12	13	14	15	L1	L2	L3
8062-68	4.75	n/a	3,385	3,463	3,553	3,664	3,821	4,044	4,267	4,491	4,714	4,937	5,161	5,384	5,607	5,831	6,054	4,339	4,564	4,785

76" SLEEPOVER BENCH

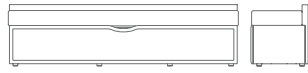

outside			seat			seat to top	arm	sleep surface		weight	cubic feet
w	d	h	sw	sd	sh	of back	height	w	d	lbs.	
76	19	20.5	76	17	18.5	n/a	n/a	76	37	210	22

model	yds com (54")	sq ft col	com 1	col 2	3	4	5	6	7	8	9	10	11	12	13	14	15	L1	L2	L3
8062-76	5	n/a	3,595	3,677	3,771	3,889	4,053	4,289	4,524	4,759	4,994	5,229	5,464	5,699	5,934	6,170	6,405	4,598	4,835	5,068

68" HIGH BACK SLEEPOVER BENCH

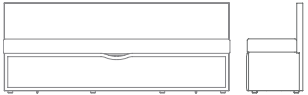

outside			seat			seat to top	arm	sleep surface		weight	cubic feet
w	d	h	sw	sd	sh	of back	height	w	d	lbs.	
68	19	30.5	68	17	18.5	n/a	n/a	68	37	180	31

model	yds com (54")	sq ft col	com 1	col 2	3	4	5	6	7	8	9	10	11	12	13	14	15	L1	L2	L3
8063-68	5.5	n/a	3,688	3,779	3,882	4,011	4,192	4,451	4,710	4,968	5,227	5,485	5,744	6,003	6,261	6,520	6,779	4,788	5,049	5,305

76" HIGH BACK SLEEPOVER BENCH

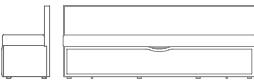

outside			seat			seat to top	arm	sleep surface		weight	cubic feet
w	d	h	sw	sd	sh	of back	height	w	d	lbs.	
76	19	30.5	76	17	18.5	n/a	n/a	76	37	215	31

model	yds com (54")	sq ft col	com 1	col 2	3	4	5	6	7	8	9	10	11	12	13	14	15	L1	L2	L3
8063-76	5.75	n/a	3,890	3,985	4,093	4,228	4,417	4,688	4,958	5,228	5,449	5,769	6,040	6,310	6,580	6,851	7,121	5,039	5,312	5,579

OPTIONS

Trundle Front	Back Caps	Tablet	Legs	Fabric 1
Standard X9 Upholstered	Standard X9 No Back Cap	Standard X9 No Selection of Option	Standard X9 No Selection of Option	Selection Required
B6Z 3DL (specify finish) \$215	3DL (specify finish) \$157 Solid Surface \$229 pair CWS Cameo White MWS Modern White CSS Concrete DMS Deep Mink	F1M Left Side Facing \$225 F1N Right Side Facing \$225 B2 HPL Right and Left Side Facing \$449	C7T Wall-Saver \$151 (set of 2)	Fabric: Grade, Vendor, Pattern, Color NOTE: For multiple fabric applications see page 14 for information and pricing

HOW TO ORDER

SPECIFY: Trundle front | back cap finish (if applicable) | tablet | tablet finish (if applicable) | legs (if applicable) | textile pattern and color. See pages 5-14 for information and options on moisture barrier, CAL133, upholstery applications, a complete offering of finishes and ordering details.

MODEL NUMBER				
8061-76				
Seat	Arm Caps	3DL Tablet with Spill Groove	3DL Center Table with Spill Groove	Fabric 1
B6X - NW3	CWS	F1M	C7T	Grade 5, Momentum, Row, Breeze

STANDARD FEATURES

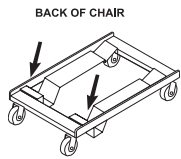

model	w	d	h	wt	cu ft	list
CDL3	22.6	32.25	8.75	32	n/a	\$ 300

- Dolly
- Available on: Lado Guest Chairs
- Stacks 6 High (Arms/Armless)

HOW TO ORDER

MODEL NUMBER

DL3

STANDARD FEATURES

BACK OF CHAIR

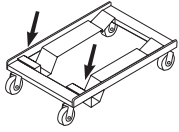

model	w	d	h	wt	cu ft	list
C2500	22.6	32.25	8.75	32	n/a	\$ 317

- Dolly
- Available on: C2009, C2012, C2409 and C2412
- Stacks 6 High (Arms/Armless)

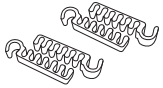

model	w	d	h	wt	cu ft	list
GD2	n/a	n/a	n/a	n/a	.25	\$ 32

- Ganging Device
- Available on: C2012, C2009, C2212, C2209, C2112, C2109, C2412, C2409, C2439, C2449
- Two Pair Per Set
- Fits 3/8" and 1" Tubing

HOW TO ORDER

MODEL NUMBER

C2500

STANDARD FEATURES

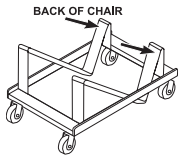

model	w	d	h	wt	cu ft	list
DL6	22.6	32.25	8.75	n/a	n/a	\$ 350

- Dolly
- Available on: Quickstacker (409, 409M, 409UB, 412, 412M and 412UB)
- Stacks 40 High (All Plastic)
- Stacks 4 High (Plastic Back and Upholstered Seat)
- Stacks 10 High (Upholstered Back and Seat)

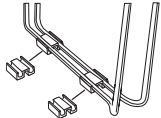

model	w	d	h	wt	cu ft	list
GD4	n/a	n/a	n/a	n/a	n/a	\$ 15

- **Ganging Device**
- Available on: Quickstacker (409, 409M, 409UB, 412, 412M and 412UB)
- One Pair Per Set
- Fits 7/16" and 7/8" Tubing

HOW TO ORDER

MODEL NUMBER

DL6

DOLLY STANDARD FEATURES

BACK OF CHAIR

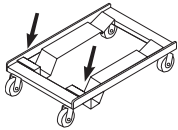

model	w	d	h	wt	cu ft	list
DL3	22.6	32.25	8.75	n/a	n/a	\$ 300

- Dolly
- Available on: Ten (701, 701M and 701UB)
- Stacks 6 High (Arms/Armless)

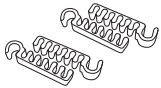

model	w	d	h	wt	cu ft	list
GD2	n/a	n/a	n/a	n/a	n/a	\$ 31

- Ganging Device
- Available on: Ten (701, 701M, 701UB, 711, 711M, 711UB)
- Two Pair Per Set
- Fits 3/8" and 1" Tubing

HOW TO ORDER

MODEL NUMBER

DL3

THROW PILLOW STANDARD FEATURES

• Removable Cover

• Hidden Zipper

• Poly Fill

22" X 11" THROW PILLOW

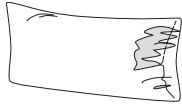

model	w	d	h	wt	cu ft
TP-22X11	22	n/a	11	n/a	n/a

yds com (54")	sq ft col	com 1	col 2	3	4	5	6	7	8	9	10	11	12	13	14	15	L1	L2	L3
1 per pillow 1 per pair	n/a	195	211	230	254	287	334	381	428	475	522	569	616	663	710	757	418	465	512

18" X 18" THROW PILLOW

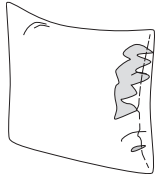

model	w	d	h	wt	cu ft
TP-18X18	18	n/a	18	n/a	n/a

yds com (54")	sq ft col	com 1	col 2	3	4	5	6	7	8	9	10	11	12	13	14	15	L1	L2	L3
1 per pillow 1.5 per pair	n/a	217	233	252	276	309	356	403	450	497	544	591	638	685	732	779	440	487	534

BOLSTER PILLOW

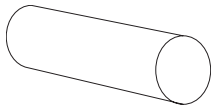

model	w	d	h	wt	cu ft
TP-BOLSTER	6	19.5	6	n/a	n/a

yds com (54")	sq ft col	com 1	col 2	3	4	5	6	7	8	9	10	11	12	13	14	15	L1	L2	L3
1 per bolster 1 per pair	n/a	195	211	230	254	287	334	381	428	475	522	569	616	663	710	757	418	465	512

OPTIONS

Fabric 1

Selection Required

Fabric: Grade, Vendor, Pattern, Color

NOTE: For multiple fabric applications see page 14 for information and pricing

HOW TO ORDER

SPECIFY: Textile pattern and color. See pages 5-14 for information and options on moisture barrier, CAL133, upholstery applications, a complete offering of finishes and ordering details.

MODEL NUMBER

TP-22x11

Fabric 1

Grade 5, Momentum, Row, Breeze

BASKET STANDARD FEATURES

- Top Options - European Beech Veneer or HPL with Lumberband Edge, Solid Surface
- Brushed Stainless Steel or Powder Coated Base
- Eased Knife Edge Detail on Tops
- Non-Marring Adjustable Glides

ROUND END TABLE



model		w	d	h	wt	cu ft	list
447-23RD	VENEER/LAMINATE	23	23	21.25	50	13	\$ 1,337
	SOLID SURFACE						\$ 1,708

SQUIRLE END TABLE



model		w	d	h	wt	cu ft	list
447-23SQ	VENEER/LAMINATE	23	23	21.25	50	13	\$ 1,417
	SOLID SURFACE						\$ 1,903

43" ROUND COCKTAIL TABLE

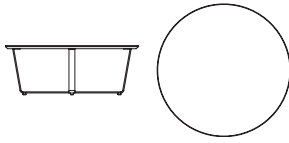

model		w	d	h	wt	cu ft	list
447-43RD	VENEER/LAMINATE	43	43	16	100	22	\$ 2,140
	SOLID SURFACE						\$ 2,998

43" SQUIRLE COCKTAIL TABLE

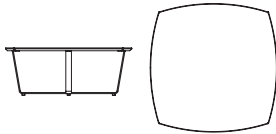

model		w	d	h	wt	cu ft	list
447-43SQ	VENEER/LAMINATE	43	43	16	100	22	\$ 2,219
	SOLID SURFACE						\$ 3,627

OVAL COCKTAIL TABLE



model		w	d	h	wt	cu ft	list
447-OVAL	VENEER/LAMINATE	49	27	16	100	22	\$ 2,116
	SOLID SURFACE						\$ 3,310

OPTIONS

Grain Pattern	Finish	Base
Selection Required	Selection Required	Standard BST Brushed Stainless Steel
B4Z Quartered	MLC BUW MGW MBM OSL MMC DST MNW MHM PCO QEC EBW MVW MRO MGO <i>Studio Veneer (10% upcharge)</i> SVC C2Q C2P	BWT Bone White BUFF Buff CHLK Chalk SGLD Gold GRPH Graphite MSL Luster Grey HIP Oiled Bronze BKO Onyx POLR Polar SBRZ Soft Bronze HIF Warm Grey Studio Powder Coats (10%) CADT Cadet CLOV Clover GLDN Goldenrod HERN Heron LATT Latte MOSS Moss RUSR Russett SUNS Sunset
B5A Flat Cut	MLC BUW MVW MHM MMC EBW MBM <i>Studio Veneer Planked (10% upcharge)</i> SFO SFW	
X9 HPL	CHP BUP HNP STP BLP SGP CMP MEP TMP VMP FWP WLP QEP NWP COP QRP GRP MGP BEP PCP KDP RWP <i>Textured Laminates (10% upcharge)</i> NGP NHP	
X9 Solid Surface	CWS Cameo White CSS Concrete DMS Deep Mink MWS Modern White	

HOW TO ORDER

SPECIFY: Top - Veneer finish, HPL or solid surface | base finish. See pages 5-14 for a complete offering of finishes and ordering details.

MODEL NUMBER

446-23RD

Grain Pattern	Finish	Base
B4Z	MLC	WHT

CASCADE STANDARD FEATURES

- NOTE: Prices Below are based on Top Option Selected, Bases are included in this Price.
- Last Digits of Model Number indicate Height; 14", 17" Or 20"
- European Beech Hardwood Frame can be Stained or Painted
- Top Options - European Beech Veneer, Paint, HPL, TFL, 3DL or Solid Surface
- Non-Marring Adjustable Glides

END TABLE



model		w	d	h	standard top wt	solid surface wt	cu ft	list
825-24RDX20	VENEER/PAINT	24	24	20	19	31	10	\$ 979
	STUDIO PAINT							\$ 1,077
	TFL							\$ 911
	HPL/3DL							\$ 1,018
	SOLID SURFACE							\$ 1,605

ROUND COFFEE TABLE



model		w	d	h	standard top wt	solid surface wt	cu ft	list
825-24RDX14	VENEER/PAINT	24	24	14	17	29	7	\$ 900
	STUDIO PAINT							\$ 990
	TFL							\$ 833
	HPL/3DL							\$ 940
	SOLID SURFACE							\$ 1,526
825-24RDX17	VENEER/PAINT	24	24	17	18	30	8	\$ 935
	STUDIO PAINT							\$ 1,029
	TFL							\$ 867
	HPL/3DL							\$ 974
	SOLID SURFACE							\$ 1,560

OPTIONS

Base Finish or Paint	Top
Selection Required	Selection Required
See page 9 for full list of finish and paint options	Veneer (Finished or Painted) HPL (Matching PVC Edge) TFL (Matching PVC Edge) 3DL Solid Surface See pages 9-10 for full list of finish, paint, HPL, TFL, 3DL and Solid Surface options

HOW TO ORDER

SPECIFY: Base - Finish or paint | Top - Finish, paint, TFL, HPL, 3DL or solid surface. See pages 5-14 for a complete offering of finishes and ordering details.

MODEL NUMBER

825-24RDX20

Base Finish or Paint	Top
MNW	WHT

CASCADE STANDARD FEATURES

- NOTE: Prices Below are based on Top Option Selected, Bases are included in this Price.
- Last Digits of Model Number indicate Height; 14", 17" Or 20"
- European Beech Hardwood Frame can be Stained or Painted
- Top Options - European Beech Veneer, Paint, HPL, TFL, 3DL or Solid Surface
- Non-Marring Adjustable Glides

EGG COFFEE TABLE

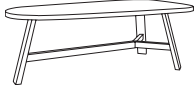

model		w	d	h	standard top wt	solid surface wt	cu ft	list
825-26X50X14	VENEER/PAINT	26	50	14	40	53	14	\$ 1,432
	STUDIO PAINT							\$ 1,575
	TFL							\$ 1,297
	HPL/3DL							\$ 1,532
	SOLID SURFACE							\$ 2,766
825-26X50X17	VENEER/PAINT	26	50	17	41	54	17	\$ 1,460
	STUDIO PAINT							\$ 1,606
	TFL							\$ 1,324
	HPL/3DL							\$ 1,558
	SOLID SURFACE							\$ 2,792

GUITAR PICK COFFEE TABLE

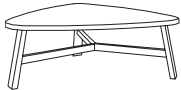

model		w	d	h	standard top wt	solid surface wt	cu ft	list
825-40X42X14	VENEER/PAINT	40	42	14	41	54	18	\$ 1,626
	STUDIO PAINT							\$ 1,789
	TFL							\$ 1,450
	HPL/3DL							\$ 1,738
	SOLID SURFACE							\$ 3,530
825-40X42X17	VENEER/PAINT	40	42	17	42	55	21	\$ 1,655
	STUDIO PAINT							\$ 1,821
	TFL							\$ 1,478
	HPL/3DL							\$ 1,765
	SOLID SURFACE							\$ 3,558

OPTIONS

Base Finish or Paint	Top
Selection Required	Selection Required
See page 9 for full list of finish and paint options	Veneer (Finished or Painted) HPL (Matching PVC Edge) TFL (Matching PVC Edge) 3DL Solid Surface See pages 9-10 for full list of finish, paint, HPL, TFL, 3DL and Solid Surface options

HOW TO ORDER

SPECIFY: Base - Finish or paint | Top - Finish, paint, TFL, HPL, 3DL or solid surface. See pages 5-14 for a complete offering of finishes and ordering details.

MODEL NUMBER	
825-26X50X14	
Base Finish or Paint	Top
MNW	WHT

EMBRACE STANDARD FEATURES

- European Beech Exposed Wood Frame
- Top Options Beech Veneer Top with Straight or Reverse Graining and Beech Lumberband Edge or HPL Top with Stained MDF Edge
- Tack-In Non-Marring Glides

ROUND END TABLE



model	w	d	h	wt	cu ft	list
EFC108-18RD	18	18	23	20	11	\$ 855

ROUND END TABLE



model	w	d	h	wt	cu ft	list
EFC108-24RD	24	24	23	40	13	\$ 939

ROUND COCKTAIL TABLE



model	w	d	h	wt	cu ft	list
EFC108-32RD	32	32	18	55	24	\$ 1,002

SQUARE END TABLE



model	w	d	h	wt	cu ft	list
EFC108-24SQ	24	24	23	40	13	\$ 924

RECTANGLE CONSOLE TABLE

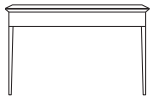

model	w	d	h	wt	cu ft	list
EFC108-18X60	60	18	36	70	36	\$ 1,179

OPTIONS

Base Finish	Top Grain Pattern	Top Finish
Selection Required	Standard A1S Straight (Veneer or HPL)	Standard X9 Veneer Match to Base with Lumberband Edge
See page 9 for full list of finish options	A1Q Reverse Diamond (Veneer only) EFC108-18RD \$219 EFC108-24RD \$275 EFC108-32RD \$330 EFC108-24SQ \$275 EFC108-18X60 \$330	HPL (Matching MDF Edge) See pages 9-10 for full list of finish and HPL options

HOW TO ORDER

SPECIFY: Base - Finish | Top - Grain pattern, finish or HPL. See pages 5-14 for a complete offering of finishes and ordering details.

MODEL NUMBER

EFC108-18RD

Base Finish	Top Grain Pattern	Top Finish
MNW	A1S	NWP

ICE STANDARD FEATURES

- Frame Welded out of 1/2" Round Nickel Plated Tubing
- Top Options - Standard Veneers, HPL, TFL, Solid Surface or Glass
- Plastic Glide fitted into the Bottom of Tubular Leg

ROUND END TABLE



model		w	d	h	wt	cu ft	list
777-20RD	VENEER/LAMINATE/GLASS	20	20	19	42	6	\$ 1,423
	SOLID SURFACE						\$ 2,048

SQUARE END TABLE



model		w	d	h	wt	cu ft	list
777-24X24	VENEER/LAMINATE/GLASS	24	24	19.5	60	8	\$ 1,436
	SOLID SURFACE						\$ 2,060

ROUND COCKTAIL TABLE



model		w	d	h	wt	cu ft	list
777-32RD	VENEER/LAMINATE/GLASS	32	32	14.75	85	10	\$ 1,777
	SOLID SURFACE						\$ 2,401

SQUARE COCKTAIL TABLE



model		w	d	h	wt	cu ft	list
777-32X32	VENEER/LAMINATE/GLASS	32	32	14.75	92	10	\$ 1,761
	SOLID SURFACE						\$ 2,385

OPTIONS

Grain Pattern	Finish	Base
Selection Required	Selection Required	Standard BCHR Brushed Chrome
B4Z Quartered	MLC BUW MGW MBM OSL MMC DST MNW MHM PCO QEC EBY MVW MRO MGO <i>Studio Veneer (10% upcharge)</i> SVC C2Q C2P	BWT Bone White BUFF Buff CHLK Chalk SGLD Gold GRPH Graphite MSL Luster Grey HIP Oiled Bronze BKO Onyx POLR Polar SBRZ Soft Bronze HIF Warm Grey Studio Powder Coats (10%) CADT Cadet CLOV Clover GLDN Goldenrod HERN Heron LATT Latte MOSS Moss RUSS Russett SUNS Sunset
B5A Flat Cut	MLC BUW MVW MHM MMC EBY MBM <i>Studio Veneer Planked (10% upcharge)</i> SFO SFW	
X9 HPL	CHP BUP HNP STP BLP SGP CMP MEP TMP VMP FWP WLP QEP NWP COP QRP GRP MGP BEP PCP KDP RWP	
X9 TFL	LC2 BU2 MH2 ST2 FW2 WL2 MC2 EN2 LM2 QR2 GR2 QE2 NW2 CO2 KD2 RW2 VM2 BE2 PC2 BL2 SG2	
X9 Solid Surface	CWS Cameo White CSS Concrete DMS Deep Mink MWS Modern White	
X9 Glass	GLS White Back Painted Tempered Mint Green Glass	

HOW TO ORDER

SPECIFY: Top - Veneer finish, HPL or solid surface | base finish. See pages 5-14 for a complete offering of finishes and ordering details.

MODEL NUMBER

777-20RD

Grain Pattern	Finish	Base
B4Z	MLC	WHT

MODERN AMENITY STANDARD FEATURES

- Top Options - European Beech or American Ash Veneer or Solid Surface
- Eased Knife Edge Detail on Table Tops
- European Beech or American Ash X Shaped Table Base
- Tack-In Non-Marring Glides
- Field Replaceable Components
- NOTE: Because of the unique Color of Ash Veneers and Hardwoods Stains are a slightly different Color than they appear on the Standard European Beech Hardwoods. If pairing with a Product using Species other than Ash the Stains will appear different. For additional information please contact your Customer Service Representative.

ROUND END TABLE



model		w	d	h	wt	cu ft	list
310-22RD	VENEER	22	22	22.25	45	9	\$ 929
	SOLID SURFACE						\$ 1,359

SQUIRICLE END TABLE



model		w	d	h	wt	cu ft	list
310-22SQ	VENEER	22	22	22.25	45	9	\$ 934
	SOLID SURFACE						\$ 1,367

OPTIONS

Wood Species	Base Finish	Top
Selection Required	Selection Required	Standard X9 Veneer Match to Base
A8S European Beech A8T American Ash	See page 9 for full list of finish options	Solid Surface See page 9 for full list of finish and Solid Surface options

HOW TO ORDER

SPECIFY: Wood species | Base - Finish | Top - Finish or solid surface. See pages 5-14 for a complete offering of finishes and ordering details.

MODEL NUMBER

310-22RD

Wood Species	Base Finish	Top
A8S	MNW	GLW

MODERN AMENITY STANDARD FEATURES

- Top Options - European Beech or American Ash Veneer or Solid Surface
 - Eased Knife Edge Detail on Table Tops
 - Tack-In Non-Marring Glides
 - Field Replaceable Components
- NOTE: Because of the unique Color of Ash Veneers and Hardwoods Stains are a slightly different Color than they appear on the Standard European Beech Hardwoods. If pairing with a Product using Species other than Ash the Stains will appear different. For additional information please contact your Customer Service Representative.

30" ROUND COCKTAIL TABLE



model		w	d	h	wt	cu ft	list
310-30RD	VENEER	30	30	17.25	55	12	\$ 1,187
	SOLID SURFACE						\$ 1,941

30" SQUIRCLE COCKTAIL TABLE



model		w	d	h	wt	cu ft	list
310-30SQ	VENEER	30	30	17.25	55	12	\$ 1,202
	SOLID SURFACE						\$ 1,955

OVAL COCKTAIL TABLE

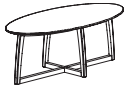

model		w	d	h	wt	cu ft	list
310-22X46	VENEER	22	46	17.25	60	13	\$ 1,302
	SOLID SURFACE						\$ 2,106

OPTIONS

Wood Species	Base Finish	Top
Selection Required	Selection Required	Standard X9 Veneer Match to Base
A8S European Beech A8T American Ash	See page 9 for full list of finish options	Solid Surface See page 9 for full list of finish and Solid Surface options

HOW TO ORDER

SPECIFY: Wood species | Base - Finish | Top - Finish or solid surface. See pages 5-14 for a complete offering of finishes and ordering details.

MODEL NUMBER

310-30RD

Wood Species	Base Finish	Top
A8S	MNW	GLW

REIN+ OCCASIONAL TABLE STANDARD FEATURES

- European Beech Hardwood Frame
- Mortise-and-Tenon Construction
- Top Options - Veneer, HPL or TFL with PVC Edge, 3DL or Solid Surface
- Non-Marring Adjustable Glides

END TABLE

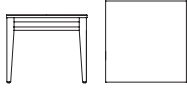

model		w	d	h	wt	cu ft	list
1810-24X24	VENEER	24	24	20	36	10	\$ 1,051
	TFL/HPL/3DL						\$ 1,189
	STUDIO TFL/HPL/3DL						\$ 1,308
	SOLID SURFACE						\$ 1,674

ROUND END TABLE

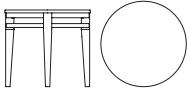

model		w	d	h	wt	cu ft	list
1810-22RD	VENEER	22	22	20	20	8	\$ 1,039
	TFL/HPL/3DL						\$ 1,066
	STUDIO TFL/HPL/3DL						\$ 1,173
	SOLID SURFACE						\$ 1,730

RECTANGULAR COFFEE TABLE

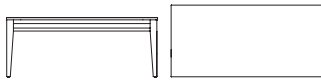

model		w	d	h	wt	cu ft	list
1810-48X24	VENEER	48	24	20	43	14	\$ 1,440
	TFL/HPL/3DL						\$ 1,546
	STUDIO TFL/HPL/3DL						\$ 1,701
	SOLID SURFACE						\$ 2,058

OVAL COFFEE TABLE

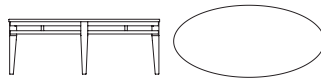

model		w	d	h	wt	cu ft	list
1810-OVAL	VENEER	46	22	17	35	13	\$ 1,551
	TFL/HPL/3DL						\$ 1,589
	STUDIO TFL/HPL/3DL						\$ 1,748
	SOLID SURFACE						\$ 4,012

OPTIONS

Base Finish	Top	Spill Groove
Selection Required	Standard X9 Veneer Match to Base	Selection Required Available only on 3DL and Solid Surface
See page 9 for full list of finish options	HPL (Matching PVC Edge) TFL (Matching PVC Edge) 3DL Solid Surface See pages 9-10 for full list HPL, TFL, 3DL and Solid Surface options	X9 None C6H Spill Groove

HOW TO ORDER

SPECIFY: Base - Finish | Top - Finish, HPL, TFL, 3DL or solid surface | spill groove. See pages 5-14 for a complete offering of finishes and ordering details.

MODEL NUMBER

1810-24X24

Base Finish	Top	Spill Groove
MNW	GLW	C6H

RETROSPECT STANDARD FEATURES

- Machine Turned Satin Aluminum Legs
- Top Options - Maple Veneer, HPL, Solid Surface or Glass
- Non-Marring Adjustable Glides

ROUND END TABLE



model		w	d	h	wt	cu ft	list
700-18RD	VENEER/LAMINATE/GLASS	18	18	23	30	11	\$ 1,641
	SOLID SURFACE						\$ 2,259

ROUND COCKTAIL TABLE



model		w	d	h	wt	cu ft	list
700-30RD	VENEER/LAMINATE/GLASS	30	30	17.5	55	16	\$ 1,972
	SOLID SURFACE						\$ 2,590

SQUARE END TABLE



model		w	d	h	wt	cu ft	list
700-24X24	VENEER/LAMINATE/GLASS	24	24	23	45	13	\$ 2,025
	SOLID SURFACE						\$ 2,643

OVAL COCKTAIL TABLE

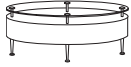

model		w	d	h	wt	cu ft	list
700-22X46	VENEER/LAMINATE/GLASS	46	22	17.5	60	30	\$ 2,266
	SOLID SURFACE						\$ 2,884

OPTIONS

Base Finish	Floating Top
Selection Required	Standard X9 Veneer Match to Base
See page 9 for full list of finish options	HPL (Matching PVC Edge) Solid Surface CWS Cameo White MWS Modern White CSS Concrete DMS Deep Mink GLS White Back Painted Tempered Mint Green Glass CG1 Tempered Mint Green Glass FGL Frosted Tempered Glass See pages 9-10 for full list of finish, HPL and Solid Surface options

HOW TO ORDER

SPECIFY: Base - Finish | Top - Finish, HPL, solid surface or glass. See pages 5-14 for a complete offering of finishes and ordering details.

MODEL NUMBER

700-18RD

Base Finish	Floating Top
MNW	GLS

SILVR ION METAL STANDARD FEATURES

- Top Options - European Beech Veneer, HPL or TFL with Matching PVC Edge
- Warm Grey (with Silver Ion Antimicrobial) Powder Coat on all Exposed Metal is Standard
- Non-Marring Adjustable Glides

ROUND END TABLE



model	w	d	h	wt	cu ft	list
470-23RD	23	23	16.5	25	13	\$ 857

COCKTAIL TABLE



model	w	d	h	wt	cu ft	list
470-46X23	46	23	16.5	45	21	\$ 1,153

OPTIONS

Powder Coat	Top
Standard HIF Warm Grey (with Silver Ion Antimicrobial)	Selection Required
See page 9 for full list of powder coat options NOTE: Any other powder coat specified will not have Silver Ion Antimicrobial technology	Veneer (Matching Edge) HPL (Matching PVC Edge) TFL (Matching PVC Edge) See pages 9-10 for full list of finish, HPL and TFL options

HOW TO ORDER

SPECIFY: Base - Powder coat | Top - Finish, HPL or TFL. See pages 5-14 for a complete offering of finishes and ordering details.

MODEL NUMBER

470-23RD

Powder Coat	Top
HIF	MNW

SILVR ION WOOD STANDARD FEATURES

- Top Options - European Beech Veneer, HPL or TFL with Matching PVC Edge
- Warm Grey (with Silver Ion Antimicrobial) Powder Coat on all Exposed Metal is Standard
- European Beech Overlay on Legs
- Non-Marring Adjustable Glides

ROUND END TABLE



model	w	d	h	wt	cu ft	list
440-23RD	23	23	16.5	25	13	\$ 1,034

COCKTAIL TABLE



model	w	d	h	wt	cu ft	list
440-46X23	46	23	16.5	45	21	\$ 1,376

OPTIONS

Beech Overlay Finish	Powder Coat	Top
Selection Required	Standard H1F Warm Grey (with Silver Ion Antimicrobial)	Standard X9 Veneer Match to Base (Matching Edge)
See page 9 for full list of finish options	See page 9 for full list of powder coat options NOTE: Any other powder coat specified will not have Silver Ion Antimicrobial technology	HPL (Matching PVC Edge) TFL (Matching PVC Edge) See pages 9-10 for full list of finish, HPL and TFL options

HOW TO ORDER

SPECIFY: Base - Finish | powder coat | Top - Finish, HPL or TFL. See **pages 5-14** for a complete offering of finishes and ordering details.

MODEL NUMBER

440-23RD

Beech Overlay Finish	Powder Coat	Top
MNW	H1F	X9

X&O TABLES STANDARD FEATURES

- Last Digits of Model Number indicate Height; 15" or 20"
- Top Options - Veneer Sides and Top or HPL Sides and Top or Solid Surface Top.
- Non-Marring Adjustable Levelers

- Optional 3" Plinth Base:**
- Increases Overall Table Height by Three Inches



20" CYLINDER TABLE



model	w	d	h	wt	cu ft	list
810-20RD-15	20	20	15	40	5	\$ 1,116
810-20RD-20	20	20	20	40	7	\$ 1,162

24" CLYINDER TABLE



model	w	d	h	wt	cu ft	list
810-24RD-15	24	24	15	50	7	\$ 1,240
810-24RD-20	24	24	20	50	9	\$ 1,294

36" CLYINDER TABLE



model	w	d	h	wt	cu ft	list
810-36RD-15	36	36	15	80	15	\$ 1,739
810-36RD-20	36	36	20	80	19	\$ 1,905

OPTIONS

Grain Pattern	Finish	Plinth Base	Top	Power
Selection Required	Selection Required	Standard X9 No Selection of Option	Standard X9 No Selection of Option	Standard X9 No Selection of Option
B4Z Quartered	MLC BUW MGW MBM OSL MMC DST MNW MHM PCO QEC EBY MVW MRO MGO <i>Studio Veneer (10% upcharge)</i> SVC C2Q C2P	810-20RD \$60 810-24RD \$90 810-36RD \$118 Solid Laminate - Selection Required BLP FWP GRP RWP SGP WLP	Solid Surface Top - Selection Required CWS, CSS, DMS, MWS 810-20RD \$413 810-24RD \$585 810-36RD \$1,436	PS-89W \$246 C6X Location on Top
B5A Flat Cut	MLC BUW MVW MHM MMC EBY MBM			
X9 HPL	CHP BUP HNP STP BLP SGP CMP MEP TMP VMP FWP WLP QEP NWP COP QRP GRP MGP BEP PCP KDP RWP	NOTE:		

HOW TO ORDER

SPECIFY: Base and top - Finish or HPL | Plinth Base | Top | Power . See pages 5-14 for a complete offering of finishes and ordering details.

MODEL NUMBER

810-20RD-15

Base and Top Finish	Finish	Plinth Base	Top	Power
B4Z	MLC	BLP	CWS	C6X

X&O TABLES STANDARD FEATURES

- Last Digits of Model Number indicate Height; 15" or 20"
- Top Options - Veneer Sides and Top or HPL Sides and Top or Solid Surface Top.
- Non-Marring Adjustable Levelers
- Tapered Cylinder
- Optional 3" Plinth Base:**
- Increases Overall Table Height by Three Inches

20" TAPERED, CYLINDER TABLE



model	w	d	h	wt	cu ft	list
810-20RDT-15	20	20	15	40	5	\$ 2,456
810-20RDT-20	20	20	20	40	7	\$ 2,530

24" TAPERED, CYLINDER TABLE



model	w	d	h	wt	cu ft	list
810-24RDT-15	24	24	15	50	7	\$ 2,786
810-24RDT-20	24	24	20	50	9	\$ 3,046

36" TAPERED, CYLINDER TABLE



model	w	d	h	wt	cu ft	list
810-36RDT-15	36	36	15	80	14	\$ 3,805
810-36RDT-20	36	36	20	80	19	\$ 3,998

OPTIONS

Grain Pattern	Finish	Plinth Base	Top	Power
Selection Required	Selection Required	Standard X9 No Selection of Option	Standard X9 No Selection of Option	Standard X9 No Selection of Option
B4Z Quartered	MLC BUW MGW MBM OSL MMC DST MNW MHM PCO QEC EBW MVW MRO MGO <i>Studio Veneer (10% upcharge)</i> SVC C2Q C2P	810-20RDT \$60 810-24RDT \$90 810-36RDT \$118 Solid Laminate - Selection Required	Solid Surface Top - Selection Required CWS, CSS, DMS, MWS 810-20RDT \$413 810-24RDT \$585 810-36RDT \$1,436	PS-89W \$246 C6X Location on Top
B5A Flat Cut	MLC BUW MVW MHM MMC EBW MBM	BLP FWP GRP RWP SGP WLP		
X9 HPL	CHP BUP HNP STP KDP RWP CMP MEP TMP VMP BLP SGP QEP NWP COP QRP FWP WLP MGP BEP PCP GRP			

HOW TO ORDER

SPECIFY: Base and top - Finish or HPL | Plinth Base | Top | Power . See pages 5-14 for a complete offering of finishes and ordering details.

MODEL NUMBER

810-20RDT-15

Base and Top Finish	Finish	Plinth Base	Top	Power
B4Z	MLC	BLP	CWS	C6X

X&O TABLES STANDARD FEATURES

- Last Digits of Model Number indicate Height; 15" or 20"
- Top Options - Veneer Sides and Top or HPL Sides and Top or Solid Surface Top.
- Non-Marring Adjustable Levelers
- Tapered Half Cylinder
- Optional 3" Plinth Base:**
- Increases Overall Table Height by Three Inches

20" TAPERED HALF, CYLINDER TABLE



model	w	d	h	wt	cu ft	list
810-20RDTH-15	20	10	15	30	3	\$ 2,306
810-20RDTH-20	20	10	20	30	4	\$ 2,399

24" TAPERED HALF, CLYINDER TABLE



model	w	d	h	wt	cu ft	list
810-24RDTH-15	24	12	15	40	4	\$ 2,636
810-24RDTH-20	24	12	20	40	5	\$ 2,698

36" TAPERED HALF, CLYINDER TABLE



model	w	d	h	wt	cu ft	list
810-36RDTH-15	36	18	15	65	8	\$ 3,555
810-36RDTH-20	36	18	20	65	10	\$ 3,676

OPTIONS

Grain Pattern	Finish	Plinth Base	Top	Power
Selection Required	Selection Required	Standard X9 No Selection of Option	Standard X9 No Selection of Option	Standard X9 No Selection of Option
B4Z Quartered	MLC BUW MGW MBM OSL MMC DST MNW MHM PCO QEC EBW MVW MRO MGO <i>Studio Veneer (10% upcharge)</i> SVC C2Q C2P	810-20RDTH \$30 810-24RDTH \$45 810-36RDTH \$60 Solid Laminate - Selection Required BLP FWP GRP RWP SGP WLP	Solid Surface Top - Selection Required CWS, CSS, DMS, MWS 810-20RDTH \$207 810-24RDTH \$293 810-36RDTH \$718	PS-89W \$246 C6X Location on Top C6Y Location on Side NOTE: Only one power supply can be specified per table.
B5A Flat Cut	MLC BUW MVW MHM MMC EBW MBM			
X9 HPL	CHP BUP HNP STP KDP RWP CMP MEP TMP VMP BLP SGP QEP NWP COP QRP FWP WLP MGP BEP PCP GRP			

HOW TO ORDER

SPECIFY: Base and top - Finish or HPL | Plinth Base | Top | Power . See pages 5-14 for a complete offering of finishes and ordering details.

MODEL NUMBER

810-20RDTH-15

Base and Top Finish	Finish	Plinth Base	Top	Power
B4Z	MLC	BLP	CWS	C6X

X&O TABLES STANDARD FEATURES

- Last Digits of Model Number indicate Height; 15" or 20"
- Top Options - Veneer Sides and Top or HPL Sides and Top or Solid Surface Top.
- Non-Marring Adjustable Levelers

- Optional 3" Plinth Base:**
- Increases Overall Table Height by Three Inches



20" CUBE TABLE



model	w	d	h	wt	cu ft	list
810-20SQ-15	20	20	15	40	5	\$ 1,299
810-20SQ-20	20	20	20	40	7	\$ 1,374

24" CUBE TABLE



model	w	d	h	wt	cu ft	list
810-24SQ-15	24	24	15	50	7	\$ 1,534
810-24SQ-20	24	24	20	50	9	\$ 1,619

36" CUBE TABLE



model	w	d	h	wt	cu ft	list
810-36SQ-15	36	36	15	90	15	\$ 2,069
810-36SQ-20	36	36	20	90	19	\$ 2,240

OPTIONS

Grain Pattern	Finish	Plinth Base	Top	Power
Selection Required	Selection Required	Standard X9 No Selection of Option	Standard X9 No Selection of Option	Standard X9 No Selection of Option
B4Z Quartered	MLC BUW MGW MBM OSL MMC DST MNW MHM PCO QEC EBW MVW MRO MGO <i>Studio Veneer (10% upcharge)</i> SVC C2Q C2P	810-20SQ \$60 810-24SQ \$90 810-36SQ \$118 Solid Laminate - Selection Required BLP FWP GRP RWP SGP WLP	Solid Surface Top - Selection Required CWS, CSS, DMS, MWS 810-20SQ \$351 810-24SQ \$597 810-36SQ \$1,491	PS-89W \$246 C6X Location on Top
B5A Flat Cut	MLC BUW MVW MHM MMC EBW MBM			
X9 HPL	CHP BUP HNP STP KDP RWP CMP MEP TMP VMP BLP SGP QEP NWP COP QRP FWP WLP MGP BEP PCP GRP			

HOW TO ORDER

SPECIFY: Base and top - Finish or HPL | Plinth Base | Top | Power . See pages 5-14 for a complete offering of finishes and ordering details.

MODEL NUMBER

810-20SQ-15

Base and Top Finish	Finish	Plinth Base	Top	Power
B4Z	MLC	BLP	CWS	C6X

X&O TABLES STANDARD FEATURES

- Last Digits of Model Number indicate Height; 15" or 20"
- Top Options - Veneer Sides and Top or HPL Sides and Top or Solid Surface Top.
- Non-Marring Adjustable Levelers
- Tapered Cube
- Optional 3" Plinth Base:**
- Increases Overall Table Height by Three Inches

20" TAPERED, CUBE TABLE



model	w	d	h	wt	cu ft	list
810-20SQT-15	20	20	15	40	5	\$ 2,402
810-20SQT-20	20	20	20	40	7	\$ 2,498

24" TAPERED, CUBE TABLE



model	w	d	h	wt	cu ft	list
810-24SQT-15	24	24	15	50	7	\$ 2,745
810-24SQT-20	24	24	20	50	9	\$ 2,998

36" TAPERED, CUBE TABLE

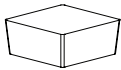

model	w	d	h	wt	cu ft	list
810-36SQT-15	36	36	15	90	14	\$ 3,719
810-36SQT-20	36	36	20	90	19	\$ 3,907

OPTIONS

Grain Pattern	Finish	Plinth Base	Top	Power
Selection Required	Selection Required	Standard X9 No Selection of Option	Standard X9 No Selection of Option	Standard X9 No Selection of Option
B4Z Quartered	MLC BUW MGW MBM OSL MMC DST MNW MHM PCO QEC EBY MVW MRO MGO <i>Studio Veneer (10% upcharge)</i> SVC C2Q C2P	810-20SQT \$60 810-24SQT \$90 810-36SQT \$118 Solid Laminate - Selection Required	Solid Surface Top - Selection Required CWS, CSS, DMS, MWS 810-20SQT \$351 810-24SQT \$597 810-36SQT \$1,491	PS-89W \$246 C6X Location on Top
B5A Flat Cut	MLC BUW MVW MHM MMC EBY MBM	BLP FWP GRP RWP SGP WLP		
X9 HPL	CHP BUP HNP STP KDP RWP CMP MEP TMP VMP BLP SGP QEP NWP COP QRP FWP WLP MGP BEP PCP GRP			

HOW TO ORDER

SPECIFY: Base and top - Finish or HPL | Plinth Base | Top | Power . See pages 5-14 for a complete offering of finishes and ordering details.

MODEL NUMBER

810-20SQT-15

Base and Top Finish	Finish	Plinth Base	Top	Power
B4Z	MLC	BLP	CWS	C6X

X&O TABLES STANDARD FEATURES

- Last Digits of Model Number indicate Height; 15" or 20"
- Top Options - Veneer Sides and Top or HPL Sides and Top or Solid Surface Top.
- Non-Marring Adjustable Levelers
- Tapered Half Cube
- Optional 3" Plinth Base:**
- Increases Overall Table Height by Three Inches

20" TAPERED HALF, CUBE TABLE



model	w	d	h	wt	cu ft	list
810-20SQTH-15	20	10	15	30	3	\$ 1,902
810-20SQTH-20	20	10	20	30	4	\$ 1,998

24" TAPERED HALF, CUBE TABLE



model	w	d	h	wt	cu ft	list
810-24SQTH-15	24	12	15	40	4	\$ 2,145
810-24SQTH-20	24	12	20	40	5	\$ 2,398

36" TAPERED HALF, CUBE TABLE

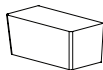

model	w	d	h	wt	cu ft	list
810-36SQTH-15	36	18	15	70	8	\$ 2,819
810-36SQTH-20	36	18	20	70	10	\$ 3,007

OPTIONS

Grain Pattern	Finish	Plinth Base	Top	Power
Selection Required	Selection Required	Standard X9 No Selection of Option	Standard X9 No Selection of Option	Standard X9 No Selection of Option
B4Z Quartered	MLC BUW MGW MBM OSL MMC DST MNW MHM PCO QEC EBY MVW MRO MGO <i>Studio Veneer (10% upcharge)</i> SVC C2Q C2P	810-20SQTH \$30 810-24SQTH \$45 810-36SQTH \$60 Solid Laminate - Selection Required BLP FWP GRP RWP SGP WLP	Solid Surface Top - Selection Required CWS, CSS, DMS, MWS 810-20SQTH \$176 810-24SQTH \$299 810-36SQTH \$746	PS-89W \$246 C6X Location on Top C6Y Location on Side NOTE: Only one power supply can be specified per table.
B5A Flat Cut	MLC BUW MVW MHM MMC EBY MBM			
X9 HPL	CHP BUP HNP STP KDP RWP CMP MEP TMP VMP BLP SGP QEP NWP COP QRP FWP WLP MGP BEP PCP GRP			

HOW TO ORDER

SPECIFY: Base and top - Finish or HPL | Plinth Base | Top | Power . See pages 5-14 for a complete offering of finishes and ordering details.

MODEL NUMBER

810-20SQTH-15

Base and Top Finish	Finish	Plinth Base	Top	Power
B4Z	MLC	BLP	CWS	C6X

X&O TABLES STANDARD FEATURES

- Last Digits of Model Number indicate Height; 15" or 20"
- Top Options - Veneer Sides and Top or HPL Sides and Top or Solid Surface Top.
- Non-Marring Adjustable Levelers
- Oval Egg Shaped
- Optional 3" Plinth Base:**
- Increases Overall Table Height by Three Inches

24" OVAL EGG TABLE



model	w	d	h	wt	cu ft	list
810-24OE-15	24	18	15	45	6	\$ 1,899
810-24OE-20	24	18	20	45	7	\$ 1,995

36" OVAL EGG TABLE



model	w	d	h	wt	cu ft	list
810-36OE-15	36	27	15	85	11	\$ 2,707

48" OVAL EGG TABLE

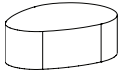

model	w	d	h	wt	cu ft	list
810-48OE-15	48	36	15	100	19	\$ 3,236

OPTIONS

Grain Pattern	Finish	Plinth Base	Top	Power
Selection Required	Selection Required	Standard X9 No Selection of Option	Standard X9 No Selection of Option	Standard X9 No Selection of Option
B4Z Quartered	MLC BUW MGW MBM OSL MMC DST MNW MHM PCO QEC EBW MVW MRO MGO <i>Studio Veneer (10% upcharge)</i> SVC C2Q C2P	810-24OE \$90 810-36OE \$118 810-48OE \$145 Solid Laminate - Selection Required	Solid Surface Top - Selection Required CWS, CSS, DMS, MWS 810-24OE \$585 810-36OE \$1,436 810-48OE \$1,612	PS-89W \$246 C6X Location on Top
B5A Flat Cut	MLC BUW MVW MHM MMC EBW MBM	BLP FWP GRP RWP SGP WLP		
X9 HPL	CHP BUP HNP STP KDP RWP CMP MEP TMP VMP BLP SGP QEP NWP COP QRP FWP WLP MGP BEP PCP GRP			

HOW TO ORDER

SPECIFY: Base and top - Finish or HPL | Plinth Base | Top | Power . See pages 5-14 for a complete offering of finishes and ordering details.

MODEL NUMBER

810-24OE-15

Base and Top Finish	Finish	Plinth Base	Top	Power
B4Z	MLC	BLP	CWS	C6X