

BASIL

Basil is a broad offering of flexible, modular seating that offers design solutions for any interior space. Straight pieces and curvilinear shapes allow designers to create forms of seating and tables that flow and support the architectural design of spaces. Optional wood and metal arms, metal legs, and numerous table designs support the product's design and its users. Built-in clean-out spaces and polyurethane arm caps make Basil equally durable in high traffic areas.

TYPICALS

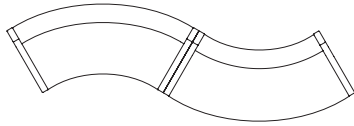

(One) 60 Inside Wedge Loveseat
(One) 60 Outside Wedge Loveseat

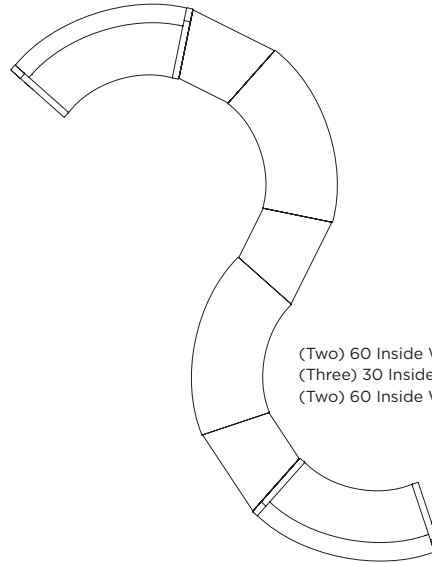

(Two) 60 Inside Wedge Loveseats
(Three) 30 Inside Wedge Tables
(Two) 60 Inside Wedge Benches

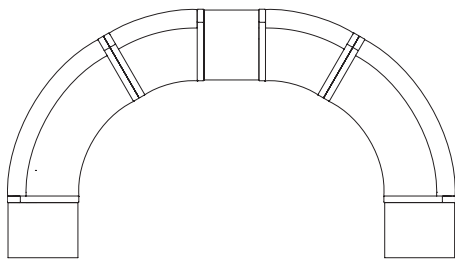

(Two) End Tables
(Two) 60 Inside Wedge Loveseats
(Two) 30 Inside Wedge Chairs
(One) M Table

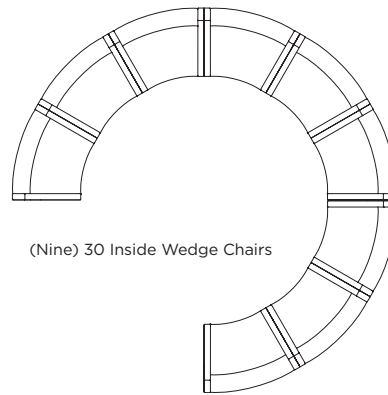

(Nine) 30 Inside Wedge Chairs

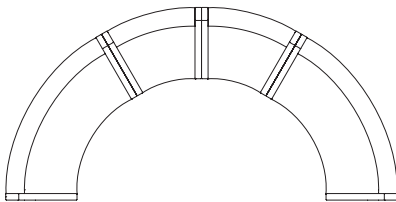

(Two) 60 Inside Wedge Loveseats
(Two) 30 Inside Wedge Chairs

ORDERING EXAMPLE:

- Specify:
- Quantity
- Product by Number
- Arms and Arm Caps
- Leg
- Wood Finish (if applicable)
- Seat Back
- Fabric 1 Grade, Vendor, Pattern and Color

MODEL NUMBER					
5110-1					
Metal Arms	Wood Arms and Arm Caps	Leg	Finish	Seat Back	Fabric 1
X9	EIZ - A4	A4	MNW	L4	Momentum, Row, Breeze

To ensure accuracy please provide Customer Service with a diagram of your specific configuration requirements at time of order.

BASIL LOUNGE MODULAR STANDARD FEATURES

- Armless
- Clean-Thru Design
- Upholstered Seat, Back and Sides on 5110-1 and 5110-2
- Upholstered Seat and Sides on 5110-B42
- Tight Cushion
- European Beech Legs
- Non-Marring Adjustable Glides
- Ganging Devices
- NOTE: Floor Plan Required for any Ganging Configurations

CHAIR

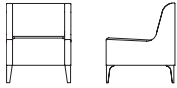

w	outside d	h	sw	seat sd	sh	seat to top of back	arm height	weight lbs.	cubic feet
26	27.5	32	21	20	18	14	n/a	60	27

model	yds com (54")	sq ft col	com 1	col 2	3	4	5	6	7	8	9	10	11	12	13	14	15	L1	L2	L3
5110-1	4	n/a	1,499	1,565	1,640	1,734	1,866	2,054	2,242	2,430	2,618	2,806	2,994	3,182	3,371	3,559	3,747	2,307	2,496	2,683

LOVESEAT

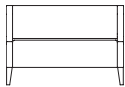

w	outside d	h	sw	seat sd	sh	seat to top of back	arm height	weight lbs.	cubic feet
47	27.5	32	42	20	18	14	n/a	90	40

model	yds com (54")	sq ft col	com 1	col 2	3	4	5	6	7	8	9	10	11	12	13	14	15	L1	L2	L3
5110-2	5	n/a	1,914	1,996	2,090	2,208	2,372	2,608	2,843	3,078	3,313	3,548	3,783	4,018	4,253	4,489	4,724	2,917	3,154	3,387

STRAIGHT BENCH



w	outside d	h	sw	seat sd	sh	seat to top of back	arm height	weight lbs.	cubic feet
42	27.5	18	n/a	n/a	n/a	n/a	n/a	75	21

model	yds com (54")	sq ft col	com 1	col 2	3	4	5	6	7	8	9	10	11	12	13	14	15	L1	L2	L3
5110-B42	2.25	n/a	1,044	1,081	1,123	1,176	1,250	1,356	1,462	1,568	1,674	1,779	1,885	1,991	2,097	2,203	2,308	1,511	1,617	1,722

BASIL METAL AND WOOD ARM STANDARD FEATURES

- Not available on Basil Bench Seating
- Brushed Aluminum Finish on Metal Arms
- Poly Arm Caps included on Metal Arm
- European Beech Wood Arm
- Poly Arm Cap optional for Wood Arm

ARM



w	outside d	h	sw	seat sd	sh	seat to top of back	arm height	weight lbs.	cubic feet
2.25	21.25	8.75	n/a	n/a	n/a	n/a	25.25	10	n/a

OPTIONS

Metal Arms	Wood Arms and Arm Caps	Leg	Arm/Leg Finish (if applicable)	Seat Back	Fabric 1
Standard X9 No Selection of Option	Standard X9 No Selection of Option	Standard C8 Wood Leg	Selection Required For EIZ, FIA, FIB and C8 Options	Standard X9 No Selection of Option	Selection Required
Black Poly Arm Cap E1W Left Side Facing \$291 E1X Right Side Facing \$291 E1Y Pair of Arms, Left and Right \$583	Wood (specify finish) E1Z Left Side Facing \$197 F1A Right Side Facing \$197 F1B Pair of Arms, Left and Right \$393 Arm Caps A4 Poly (black) \$105 per arm cap	D1E Brushed Aluminum Metal Leg	See page 9 for full list of finish options	L4 Back Bump Guard \$183	Fabric: Grade, Vendor, Pattern, Color NOTE: For multiple fabric applications see page 14 for information and pricing

HOW TO ORDER

SPECIFY: Arms and arm caps | legs | wood finish (if applicable) | seat back | textile pattern and color. See pages 5-14 for information and options on moisture barrier, CAL133, upholstery applications, a complete offering of finishes and ordering details.

MODEL NUMBER

5110-1

Metal Arms	Wood Arms and Arm Caps	Leg	Arm/Leg Finish (if applicable)	Seat Back	Fabric 1
X9	E1Z - A4	C8	MNW	L4	Grade 5, Momentum, Row, Breeze

BASIL LOUNGE MODULAR STANDARD FEATURES

- Armless
- Clean-Thru Design
- Upholstered Seat, Back and Sides
- Tight Cushion
- European Beech Legs
- Ganging Devices
- Non-Marring Adjustable Glides
- NOTE: Floor Plan Required for any Ganging Configurations

30° INSIDE WEDGE CHAIR

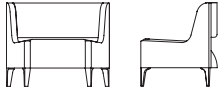

w	outside			sw	seat			seat to top of back	arm height	weight lbs.	cubic feet
	d	h			sd	sh					
39.5	29	32		23	20	18	14	n/a	62	38	

model	yds com (54")	sq ft col	com 1	col 2	3	4	5	6	7	8	9	10	11	12	13	14	15	L1	L2	L3
5110-30i	4.75	n/a	1,855	1,933	2,023	2,134	2,291	2,514	2,737	2,961	3,184	3,407	3,631	3,854	4,077	4,301	4,524	2,809	3,034	3,255

30° OUTSIDE WEDGE CHAIR

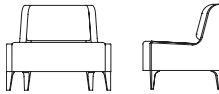

w	outside			sw	seat			seat to top of back	arm height	weight lbs.	cubic feet
	d	h			sd	sh					
39.5	29	32		23	20	18	14	n/a	62	38	

model	yds com (54")	sq ft col	com 1	col 2	3	4	5	6	7	8	9	10	11	12	13	14	15	L1	L2	L3
5110-30o	4.75	n/a	1,855	1,933	2,023	2,134	2,291	2,514	2,737	2,961	3,184	3,407	3,631	3,854	4,077	4,301	4,524	2,809	3,034	3,255

BASIL METAL AND WOOD ARM STANDARD FEATURES

- Not available on Basil Bench Seating
- Brushed Aluminum Finish on Metal Arms
- Poly Arm Caps included on Metal Arm
- European Beech Wood Arm
- Poly Arm Cap optional for Wood Arm

ARM



w	outside			sw	seat			seat to top of back	arm height	weight lbs.	cubic feet
	d	h			sd	sh					
2.25	21.25	8.75		n/a	n/a	n/a	n/a	25.25	10	n/a	

OPTIONS

Metal Arms	Wood Arms and Arm Caps	Leg	Arm/Leg Finish (if applicable)	Seat Back	Fabric 1
Standard X9 No Selection of Option	Standard X9 No Selection of Option	Standard C8 Wood Leg	Selection Required For EIZ, FIA, FIB and C8 Options	Standard X9 No Selection of Option	Selection Required
With Black Poly Arm Cap E1W Left Side Facing \$291 E1X Right Side Facing \$291 E1Y Pair of Arms, Left and Right \$583	Wood (specify finish) E1Z Left Side Facing \$197 F1A Right Side Facing \$197 F1B Pair of Arms, Left and Right \$393 Arm Caps A4 Poly (black) \$105 per arm cap	D1E Brushed Aluminum Metal Leg	See page 9 for full list of finish options	L4 Back Bump Guard \$183	Fabric: Grade, Vendor, Pattern, Color NOTE: For multiple fabric applications see page 14 for information and pricing

HOW TO ORDER

SPECIFY: Arms and arm caps | legs | wood finish (if applicable) | seat back | textile pattern and color. See pages 5-14 for information and options on moisture barrier, CAL133, upholstery applications, a complete offering of finishes and ordering details.

MODEL NUMBER

5110-301

Metal Arms	Wood Arms and Arm Caps	Leg	Arm/Leg Finish (if applicable)	Seat Back	Fabric 1
X9	E1Z - A4	C8	MNW	L4	Grade 5, Momentum, Row, Breeze

BASIL LOUNGE MODULAR STANDARD FEATURES

- Armless
- Clean-Thru Design
- Upholstered Seat, Back and Sides
- Double Top Stitch in Center of Seat and Back
- Tight Cushion
- European Beech Legs
- Ganging Devices
- Non-Marring Adjustable Glides
- NOTE: Floor Plan Required for any Ganging Configurations

60° INSIDE WEDGE LOVESEAT

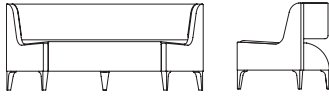

w	outside d	h	sw	seat sd	sh	seat to top of back	arm height	weight lbs.	cubic feet
73	33.75	32	42	20	18	14	n/a	95	80

model	yds com (54")	sq ft col	com 1	col 2	3	4	5	6	7	8	9	10	11	12	13	14	15	L1	L2	L3
5110-60i	7.25	n/a	2,805	2,924	3,061	3,231	3,470	3,811	4,152	4,493	4,833	5,174	5,515	5,856	6,197	6,538	6,879	4,246	4,590	4,928

60° OUTSIDE WEDGE LOVESEAT

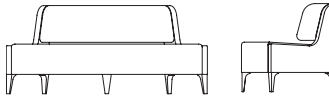

w	outside d	h	sw	seat sd	sh	seat to top of back	arm height	weight lbs.	cubic feet
73	33.75	32	42	20	18	14	n/a	95	80

model	yds com (54")	sq ft col	com 1	col 2	3	4	5	6	7	8	9	10	11	12	13	14	15	L1	L2	L3
5110-60o	7.25	n/a	2,819	2,938	3,075	3,245	3,484	3,825	4,166	4,507	4,847	5,188	5,529	5,870	6,211	6,552	6,893	4,260	4,604	4,942

BASIL METAL AND WOOD ARM STANDARD FEATURES

- Not available on Basil Bench Seating
- Brushed Aluminum Finish on Metal Arms
- Poly Arm Caps included on Metal Arm
- European Beech Wood Arm
- Poly Arm Cap optional for Wood Arm

ARM



w	outside d	h	sw	seat sd	sh	seat to top of back	arm height	weight lbs.	cubic feet
2.25	21.25	8.75	n/a	n/a	n/a	n/a	25.25	10	n/a

OPTIONS

Metal Arms	Wood Arms and Arm Caps	Leg	Arm/Leg Finish (if applicable)	Seat Back	Fabric 1
Standard X9 No Selection of Option	Standard X9 No Selection of Option	Standard C8 Wood Leg	Selection Required For E1Z, F1A, F1B and C8 Options	Standard X9 No Selection of Option	Selection Required
With Black Poly Arm Cap E1W Left Side Facing \$291 E1X Right Side Facing \$291 E1Y Pair of Arms, Left and Right \$583	Wood (specify finish) E1Z Left Side Facing \$197 F1A Right Side Facing \$197 F1B Pair of Arms, Left and Right \$393 Arm Caps A4 Poly (black) \$105 per arm cap	D1E Brushed Aluminum Metal Leg	See page 9 for full list of finish options	L4 Back Bump Guard \$183	Fabric: Grade, Vendor, Pattern, Color NOTE: For multiple fabric applications see page 14 for information and pricing

HOW TO ORDER

SPECIFY: Arms and arm caps | legs | wood finish (if applicable) | seat back | textile pattern and color. See pages 5-14 for information and options on moisture barrier, CAL133, upholstery applications, a complete offering of finishes and ordering details.

MODEL NUMBER

5110-60i

Metal Arms	Wood Arms and Arm Caps	Leg	Arm/Leg Finish (if applicable)	Seat Back	Fabric 1
X9	E1Z - A4	C8	MNW	L4	Grade 5, Momentum, Row, Breeze

BASIL BENCH MODULAR STANDARD FEATURES

- Ganging Devices
- Upholstered Seat and Sides
- Non-Marring Adjustable Glides
- Armless
- Tight Cushion
- NOTE: Floor Plan Required for any Ganging Configurations
- Clean-Thru Design
- European Beech Legs

30° INSIDE WEDGE BENCH



outside			seat			seat to top of back	arm height	weight lbs.	cubic feet
w	d	h	sw	sd	sh				
35	29	18	n/a	n/a	n/a	n/a	n/a	47	16

model	yds com (54")	sq ft col	com 1	col 2	3	4	5	6	7	8	9	10	11	12	13	14	15	L1	L2	L3
5110-b30i	2	n/a	987	1,020	1,058	1,105	1,170	1,264	1,358	1,453	1,547	1,641	1,735	1,829	1,923	2,017	2,111	1,405	1,500	1,593

30° OUTSIDE WEDGE BENCH



outside			seat			seat to top of back	arm height	weight lbs.	cubic feet
w	d	h	sw	sd	sh				
35	29	18	n/a	n/a	n/a	n/a	n/a	47	16

model	yds com (54")	sq ft col	com 1	col 2	3	4	5	6	7	8	9	10	11	12	13	14	15	L1	L2	L3
5110-b30o	2	n/a	987	1,020	1,058	1,105	1,170	1,264	1,358	1,453	1,547	1,641	1,735	1,829	1,923	2,017	2,111	1,405	1,500	1,593

60° INSIDE WEDGE BENCH

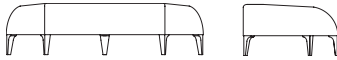

outside			seat			seat to top of back	arm height	weight lbs.	cubic feet
w	d	h	sw	sd	sh				
69	33	18	n/a	n/a	n/a	n/a	n/a	75	35

model	yds com (54")	sq ft col	com 1	col 2	3	4	5	6	7	8	9	10	11	12	13	14	15	L1	L2	L3
5110-b60i	3	n/a	1,514	1,563	1,620	1,690	1,789	1,930	2,071	2,212	2,353	2,494	2,636	2,777	2,918	3,059	3,200	2,127	2,269	2,409

60° OUTSIDE WEDGE BENCH



outside			seat			seat to top of back	arm height	weight lbs.	cubic feet
w	d	h	sw	sd	sh				
69	33	18	n/a	n/a	n/a	n/a	n/a	75	34

model	yds com (54")	sq ft col	com 1	col 2	3	4	5	6	7	8	9	10	11	12	13	14	15	L1	L2	L3
5110-b60o	3.25	n/a	1,520	1,573	1,635	1,711	1,818	1,971	2,124	2,276	2,429	2,582	2,735	2,888	3,041	3,193	3,346	2,182	2,336	2,487

90° INSIDE CORNER BENCH



outside			seat			seat to top of back	arm height	weight lbs.	cubic feet
w	d	h	sw	sd	sh				
59	29.5	18	n/a	n/a	n/a	n/a	n/a	67	23

model	yds com (54")	sq ft col	com 1	col 2	3	4	5	6	7	8	9	10	11	12	13	14	15	L1	L2	L3
5110-b90i	2.5	n/a	1,209	1,250	1,297	1,356	1,438	1,556	1,673	1,791	1,908	2,026	2,144	2,261	2,379	2,496	2,614	1,724	1,843	1,959

90° OUTSIDE CORNER BENCH

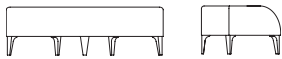

outside			seat			seat to top of back	arm height	weight lbs.	cubic feet
w	d	h	sw	sd	sh				
59	29.5	18	n/a	n/a	n/a	n/a	n/a	67	23

model	yds com (54")	sq ft col	com 1	col 2	3	4	5	6	7	8	9	10	11	12	13	14	15	L1	L2	L3
5110-b90o	2.5	n/a	1,209	1,250	1,297	1,356	1,438	1,556	1,673	1,791	1,908	2,026	2,144	2,261	2,379	2,496	2,614	1,724	1,843	1,959

OPTIONS

Leg	Arm/Leg Finish (if applicable)	Fabric 1
Standard C8 Wood Leg	Selection Required For C8 Option	Selection Required
DIE Brushed Aluminum Metal Leg	See page 9 for full list of finish options	Fabric: Grade, Vendor, Pattern, Color NOTE: For multiple fabric applications see page 14 for information and pricing

HOW TO ORDER

SPECIFY: Legs | wood finish (if applicable) | textile pattern and color. See pages 5-14 for information and options on moisture barrier, CAL133, upholstery applications, a complete offering of finishes and ordering details.

MODEL NUMBER

5110-B30I

Leg	Arm/Leg Finish (if applicable)	Fabric 1
C8	MNW	Grade 5, Momentum, Row, Breeze

BASIL END TABLE STANDARD FEATURES

- Some Field Installation required
- European Beech Legs
- Non-Marring Adjustable Glides
- Ganging Devices
- Top Options - Beech Veneer or HPL with Self Edge
- NOTE: Floor Plan Required for any Ganging Configurations

LEFT STRAIGHT END TABLE



model	w	d	h	wt	cu ft	list
5110-E-LT	21	26.5	9	30	20	\$ 982

RIGHT STRAIGHT END TABLE



model	w	d	h	wt	cu ft	list
5110-E-RT	21	26.5	9	30	20	\$ 982

30° LEFT INSIDE WEDGE END TABLE



model	w	d	h	wt	cu ft	list
5110-30I-LT	34.75	25.75	9	32	26	\$ 1,226

30° LEFT OUTSIDE WEDGE END TABLE



model	w	d	h	wt	cu ft	list
5110-30O-LT	34.75	25.75	9	32	26	\$ 1,226

30° RIGHT INSIDE WEDGE END TABLE



model	w	d	h	wt	cu ft	list
5110-30I-RT	34.75	25.75	9	32	26	\$ 1,226

30° RIGHT OUTSIDE WEDGE END TABLE



model	w	d	h	wt	cu ft	list
5110-30O-RT	34.75	25.75	9	32	26	\$ 1,226

OPTIONS

Leg	Top
Standard	Selection Required
C8 Wood Leg (specify finish)	
D1E Brushed Aluminum Metal Leg	Veneer (Matching Edge) HPL (Self Edge) See pages 9-10 for full list of finish and HPL options

HOW TO ORDER

SPECIFY: Legs | wood finish (if applicable) | Top - Veneer or HPL. See **pages 5-14** for a complete offering of finishes and ordering details.

MODEL NUMBER

5110-E-LT

Leg	Top
D1E	MNW

BASIL CORNER TABLE STANDARD FEATURES

- Some Field Installation required
- European Beech Legs
- Non-Marring Adjustable Glides
- Ganging Devices
- Top Options - Beech Veneer or HPL with Self Edge
- NOTE: Floor Plan Required for any Ganging Configurations

90° INSIDE CORNER TABLE



w	outside d	h	sw	seat sd	sh	seat to top of back	arm height	weight lbs.	cubic feet
59	29.5	15	n/a	n/a	n/a	n/a	n/a	72	44

model	yds com (54")	sq ft col	com 1	col 2	3	4	5	6	7	8	9	10	11	12	13	14	15	L1	L2	L3
5110-90I	2	n/a	1,506	1,539	1,577	1,624	1,689	1,783	1,877	1,972	2,066	2,160	2,254	2,348	2,442	2,536	2,630	1,924	2,019	2,112

90° OUTSIDE CORNER TABLE

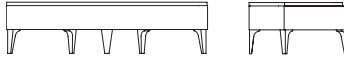

w	outside d	h	sw	seat sd	sh	seat to top of back	arm height	weight lbs.	cubic feet
59	29.5	15	n/a	n/a	n/a	n/a	n/a	72	44

model	yds com (54")	sq ft col	com 1	col 2	3	4	5	6	7	8	9	10	11	12	13	14	15	L1	L2	L3
5110-90O	2	n/a	1,506	1,539	1,577	1,624	1,689	1,783	1,877	1,972	2,066	2,160	2,254	2,348	2,442	2,536	2,630	1,924	2,019	2,112

OPTIONS

Leg	Top	Fabric 1
Standard C8 Wood Leg (specify finish)	Selection Required	Selection Required
DIE Brushed Aluminum Metal Leg	Veneer (Matching Edge) HPL (Self Edge) See pages 9-10 for full list of finish and HPL options	Fabric: Grade, Vendor, Pattern, Color NOTE: For multiple fabric applications see page 14 for information and pricing

HOW TO ORDER

SPECIFY: Legs | wood finish (if applicable) | Top - Veneer or HPL | textile pattern and color. See pages 5-14 for information and options on moisture barrier, CAL133, upholstery applications, a complete offering of finishes and ordering details.

MODEL NUMBER

5110-90I

Leg	Top	Fabric 1
DIE	MNW	Grade 5, Momentum, Row, Breeze

BASIL GANGING TABLE STANDARD FEATURES

- Some Field Installation required
- Ganging Devices
- Top Options - Beech Veneer or HPL with Self Edge
- NOTE: Floor Plan Required for any Ganging Configurations

STRAIGHT MIDDLE TABLE

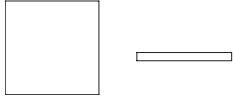

model	w	d	h	wt	cu ft	list
5110-M	21	26.5	2	30	20	\$ 545

30° INSIDE/OUTSIDE WEDGE MIDDLE TABLE

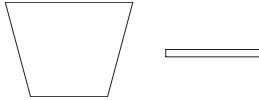

model	w	d	h	wt	cu ft	list
5110-30-I-O	34.75	25.75	2	30	26	\$ 982

60° INSIDE/OUTSIDE WEDGE MIDDLE TABLE



model	w	d	h	wt	cu ft	list
5110-60	47.5	23	2	47	34	\$ 1,002

OPTIONS

Top

Selection Required

Veneer (Matching Edge)
HPL (Self Edge)

See pages 9-10 for full list of finish and HPL options

HOW TO ORDER

SPECIFY: Top - Veneer or HPL. See pages 5-14 for a complete offering of finishes and ordering details.

MODEL NUMBER

5110-M

Top

MNW