

Fleet building blocks





Table of contents

Statement of line	3
Tables	3
Tables elevations	3
Table shapes	4
Table base options	4
Bar & counter height options	5
Foot ring/rail options	5
Canopy options	6
Canopy details	6
Media screen options	7
Pivoting tables	8
Rotation details	8
Modular tables	9
Power options	10
Power trays	11
Wire management	11
Power distribution	12
Stools	13
Stool elevations	13
Bench elevations	14
Benches	14
Planters	15
Round planter elevations	15
Round planters	15
Racetrack planter elevations	16
Racetrack planter	16
Planter liner details	17



Statement of line

- Tables
- Canopy
- Pivoting tables
- Modular tables
- Power & accessories
- Wire management
- Stools
- Planters

Tables

Details

- Tables shipped knocked down
- Tables are available in 6 shapes
- Underside of surface is black
- Cap at bottom of leg is always black
- All non-modular tables are available with glides or casters
- Casters available in black, white, & grey
- Tables come standard desk, counter, and bar height
- Table tops available in TFL, HPL, and veneer with a matching edgeband or plywood edgeband
- Bases are available in standard and studio powder coats

Elevations

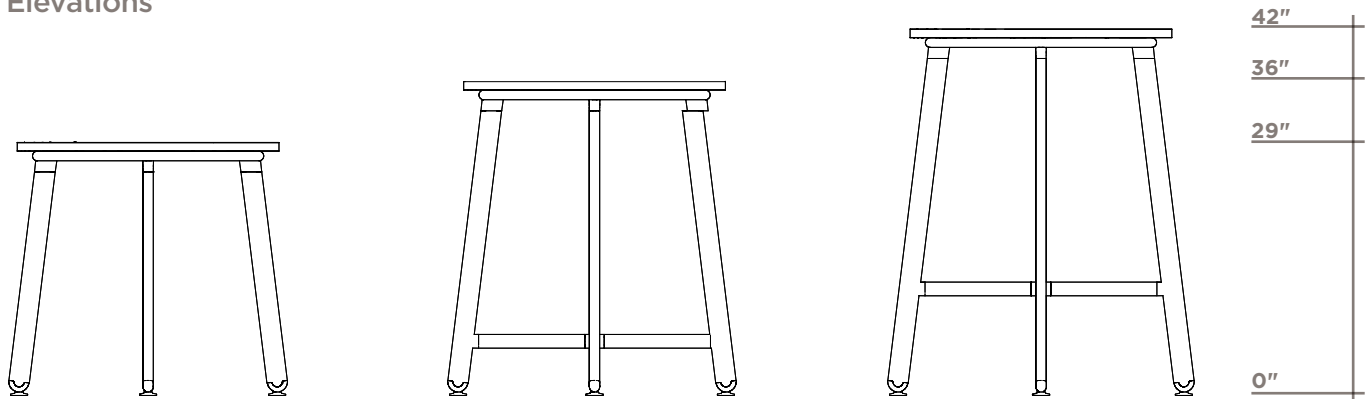

Desk height



Counter height



Bar height

Table shapes



Round
Desk, counter, & bar height



Racetrack
Desk, counter, & bar height



Modular bullet - starter & ender
Desk, counter, & bar height



Modular rectangular - add on
Desk, counter, & bar height



Modular 30 wedge - add on
Desk, counter, & bar height



Modular 45 wedge - add on
Desk, counter, & bar height

Table base options

- Tables over 84" in length can only have a glide foot.



Glide
A4F

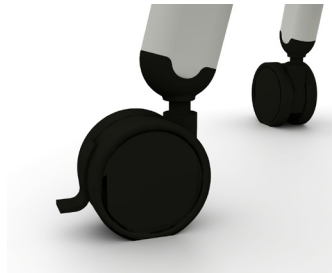

Black caster
BLKC

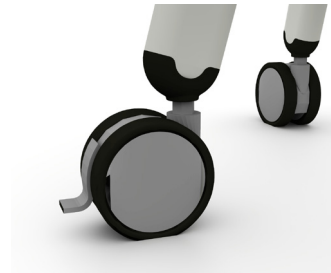

Grey caster
GRYC

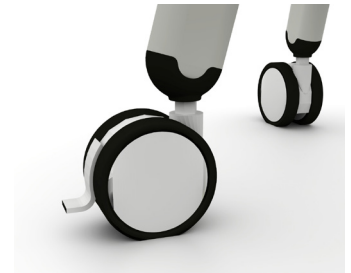

White caster
WHTC

Bar & counter height options

- Counter and bar height tables have a standard foot rail
 - 7" height on counter & 13" high on bar
- The following table sizes have the option for a foot ring instead of rail:
 - 36" & 54" round bar height only, 72"x24", 78"x30", 84"x36", and 96"x42" counter and bar height

Foot ring/rail options



Foot rail
TFTR
Standard option



36" round
Counter height



96"x42" racetrack
Bar height



Foot ring
TFNG
Option on specific sizes called out above



36" round
Counter height



96"x42" racetrack
Bar height

Canopy options

- Canopy only available on 96"x42" racetrack, bar height table and modular 78" & 75" wide modular bar height bullet tops
- Canopy available in 4 PET colors
- Canopy PET has NRC rating of .7
- Canopy support available in standard and studio powder coats
- Canopy and media screen are ordered separately
- Optional light available for canopy available in standard and studio powder coats
- Power kits available for canopy and media screen
 - Canopy power kit mounts under table and has 2 outlets
 - Media power kit mounts between panels on media screen and has 2 outlets

Canopy details



Light in canopy option
LGHT



Canopy power kit
CPWR



Canopy only
CNPY



Canopy & media screen
CNPS
x9 No TV mount panel



Canopy & media screen
CNPS
BKMS or FTMS Front OR back TV mount panel



Canopy & media screen
CNPS
FBMS Front AND back TV mount panel

Media screen options

- Media screen available for canopy and attaches to a single support rail
- Media screen available with TV mount option on front, back, or both sides
- 42" TV the largest TV able to mount to TV mount
- Media screen available upholstered, TFL, HPL, and veneer
- Media power kit mounted between screens adjacent to TV mount and plugs into table power



Upholstered | Upholstered
XV | XV



Laminate | Upholstered
T | XV



Laminate | Laminate
T | T



Veneer | Veneer
V | V



Veneer | Upholstered
V | XV



Veneer | Laminate
V | T



Media power kit
MPWR



Pivoting table

- Pivoting racetrack table available in 6 sizes
- The top table is always 12" larger than the bottom table
- Upper table height is 31" and lower table height is 28"
- Table can pivot full 360 degrees with 90 degree stops
- Table pivots on a ball bearing system
- Tables available in laminate and veneer
- Power options available in both upper and lower tables
- Lower table can only have a PS-92 & PS-93 power unit
- Power tray only available for upper table
- Pivoting table always comes on casters



Pivoting table
Shown at 0 degree rotation



Pivoting table
Shown at 90 degree rotation

Rotation details



0 degree rotation



90 degree rotation



180 degree rotation



270 degree rotation



0 degree rotation

Modular tables

- Modular tables are available in desk, counter, and bar height
- Consist of starter, add-on, and ender units
- Modular tables are available in 42" and 48" depths
- Modular tables are available with glides
- Max straight table length not to exceed 168"
- Modular tables must begin and end with a bullet top
- Table configurations can not exceed the use of more than 10 modular tops of any size
- Canopy available on 78" & 75" wide modular bullet tops
- Configured tables can consist of just a starter and ender
- When using wedge shaped tops, grain will not pattern match



Modular bullet starter
Starts a configuration



Modular bullet ender
Ends a configuration



Modular bullet add-on
Connects to both a starter and ender unit
Can also attach to another add on unit



Modular 30 degree add-on
Connects to both a starter and ender unit
Can also attach to another add on unit



Modular 45 degree add-on
Connects to both a starter and ender unit
Can also attach to another add on unit

Configuration examples



Configuration with 30 degree add-on



Configuration with 45 degree add-on



Configuration with rectangular add-on

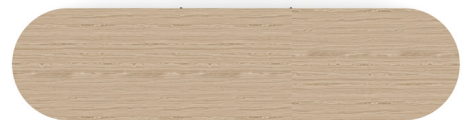
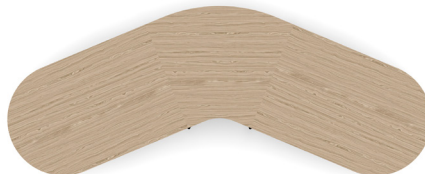

Power options

- Power is only specified through the table and not separate
- Power options available for every table
- There are 4 power unit options: PS-91B/W-P, PS-92B/W-P, PS-93B/W-P, PS-102B/W-P
- Canopy and media power kits available together or separate, are location below the table or in the media unit
- Power units are available in black or white distinguished by the B or W in the part number
- Round tables 42" and wider can have 2 power cut outs 13.5" apart
- Racetrack tables 24" deep and 54"x30", 60"x30", and 66"x42" can have 2 power cut outs 6.75" apart
- Racetrack tables 66"x30" and larger can have 2 power cut outs 13.5" apart
- Power cut out codes: QS center cutout, DUL dual cutout 6.75" apart, and PDLT dual cutout 13.5" apart
- Lower table on pivoting tables can only have a PS-92 or PS-93 because of clearance to upper table
- Only one power in-feed leg required per table configuration

Power unit options



PS-91W-P
Three 15 amp outlets, one USB A+C charging ports



PS-92W-P
One power outlet, one USB A+C charging ports



PS-93W-P
One power outlet, two USB-A charging ports, two wireless charging mats



PS-102W-P
Two power outlets, one USB A+C charging ports



PS-91W-P Dual
Three 15 amp outlets, one USB A+C charging ports



PS-92W-P Dual
One power outlet, one USB A+C charging ports



PS-93W-P Dual
One power outlet, two USB-A charging ports, two wireless charging mats



PS-102W-P Dual
Two power outlets, one USB A+C charging ports

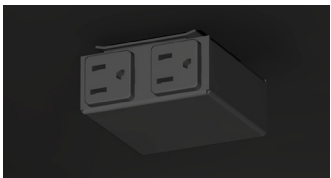

Canopy power kit CPWR
Two 15 amp outlets



Media power kit MPWR
Two 15 amp outlets

Power trays

- Raises the power supply above the worksurface
- For use with PS-92 and PS-102 units
- Available in solid white oak, solid walnut, or standard and studio paints
- Center pencil tray available in PET or cork
- Center cup available in all standard and studio powder coats



20-PT1
For use with single cut out power location QS



20-PT2
For use with dual cut out power location DUL



20-PT3
For use with dual cut out power location PDLT
Center pencil tray



20-PT4
For use with dual cut out power location PDLT
Center pencil cup

Wire management

- Mesh wire management available in 6 sizes for specific table sizes
- Available in 8 mesh colors
- Mesh snaps into place below table concealing cords, clip, and power supply from view
- When power is specified part of the power cord will come factory installed in one of the legs

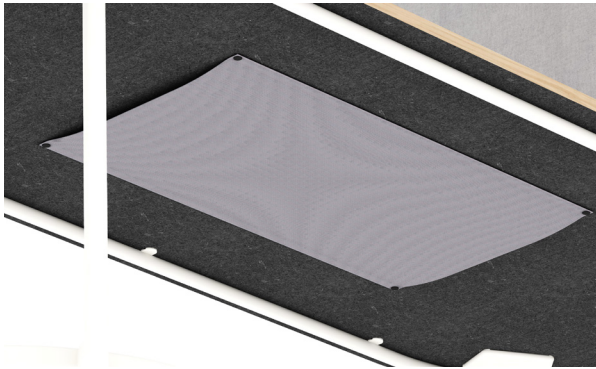

Mesh wire manager
View from below table



Wire chase in leg
Detail of power cord coming out at bottom of leg

Power distribution

- All Fleet power is modular
- All power configuration above worksurface is hidden in structure
- Power below worksurface is attached to underside of surface, or factory installed in leg
- All wiring configurations are included with specification

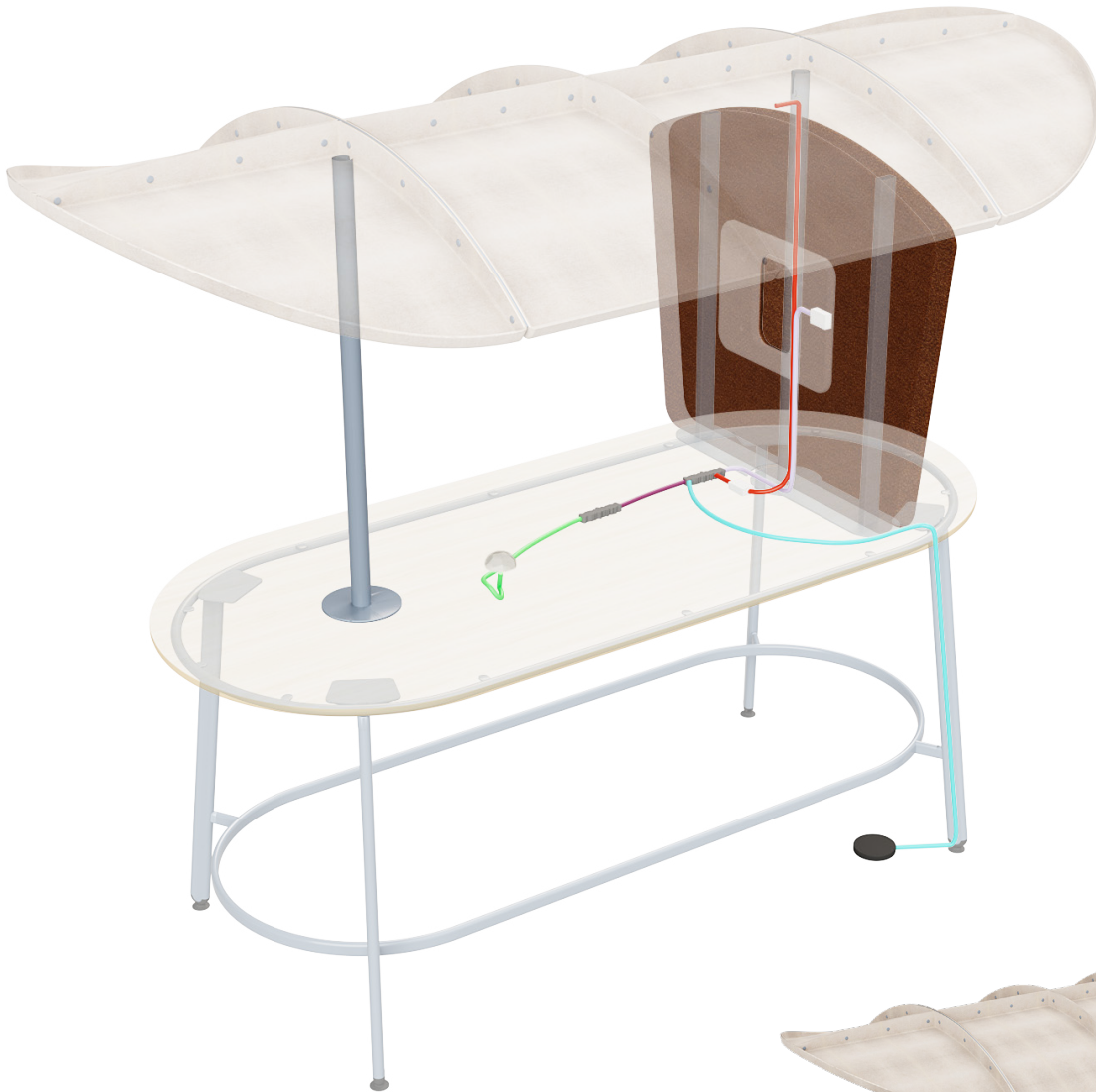

- All modular power gets routed to one in feed
- **Red** cord represents optional light cord
- **Purple** cord represents the optional canopy power kit
- **Green** cord represents the optional surface power
- **White** cord represents the optional media power kit
- **Blue** cord represents the infeed
- Cord are connected through jumpers and blocks

Stools

- Stools available in single and bench size
- Steel frame available in standard and studio powder coats
- Caster option available on desk height stool

Stool elevations

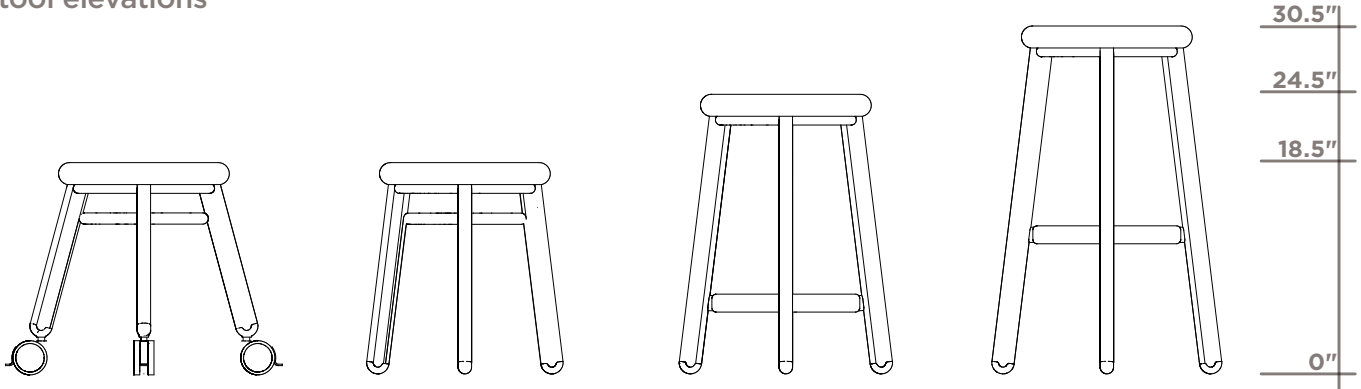

Stools



Mobile stool



Desk height stool



Counter height stool



Bar height stool



Bench elevations

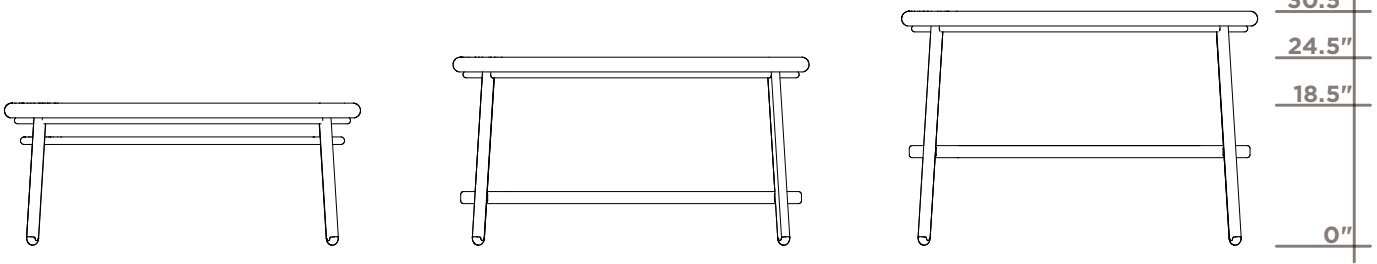

Benches



Desk height bench



Counter height bench



Bar height bench

Planters

- Planters available in round and racetrack size
- Steel frame available in standard and studio powder coats
- Caster option available on desk height round planter
- Optional planter liner available

Round planter elevations

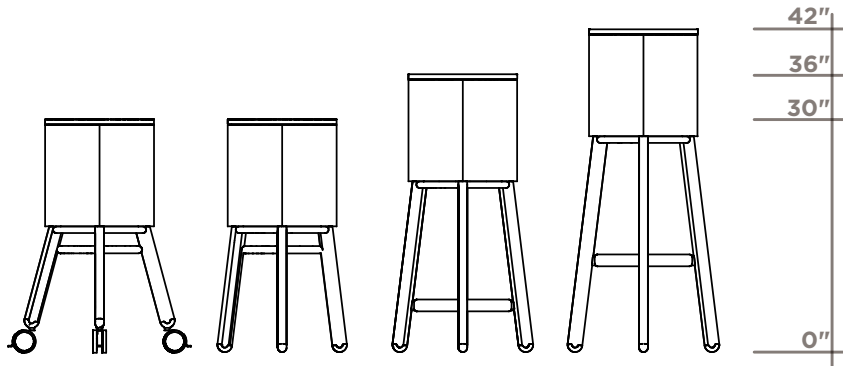

Round planters



Mobile round planter

Desk height round planter

Counter height round planter

Bar height round planter

Racetrack planter elevations

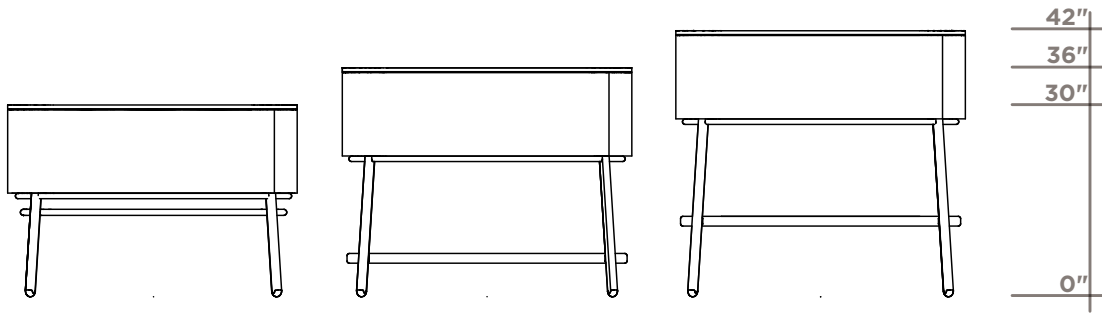

Racetrack planters



Desk height racetrack planter



Counter height racetrack planter



Bar height racetrack planter

Planter liners

- Planter liners are optional
- Planter liners have self irrigation system
- Instruction booklet comes with all liners

Planter liner details

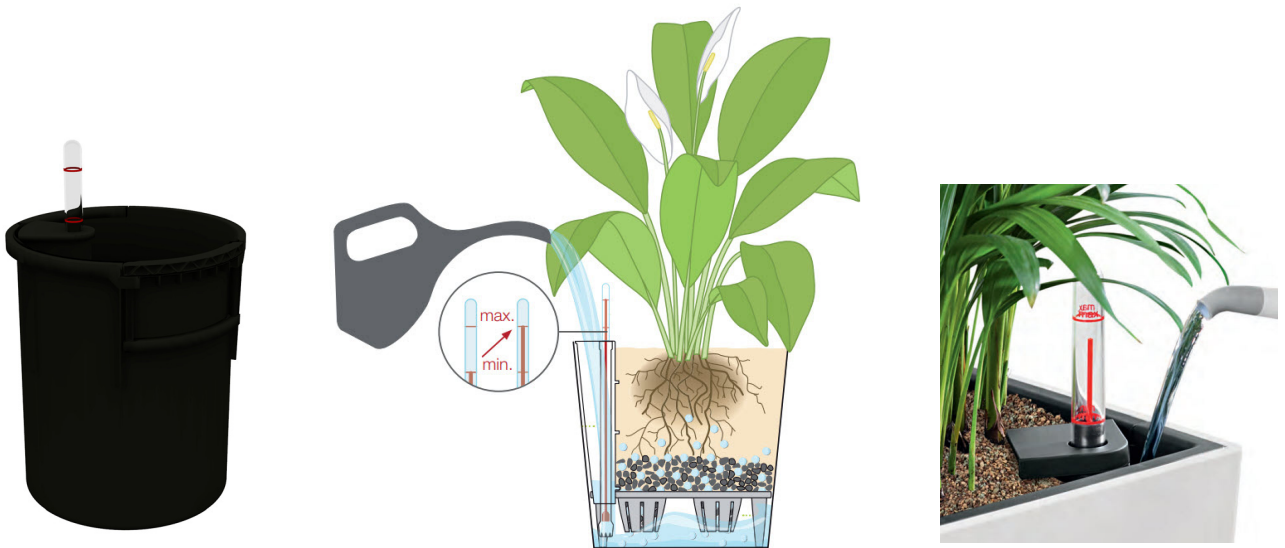

Planter liner

- Water reservoir to be filled after manually watering the plants for 12 weeks, then reservoir is filled when the gauge shows empty.
- Separate water reservoir that is filled every 12 weeks that slowly disperses water to the plant
- Water is filled up the max line indicator
- Every third watering, water the plant from above to hydrate the substrate



Liner in round planter



Liner in racetrack planter