

Staks worksurface support rules



Support Types:

Worksurface support brackets

These consist of the following models:

- WSBKT22-36 (Does not allow for wire basket pass-through, old style)
3 sizes: 22", 30" and 36"
- OWSBKT22-36 (Standard bracket, allows wire basket pass-through)
3 sizes: 22", 30" and 36"
- WSBKTC - Mini Concealed Cantilever Bracket
- WSBKTC22 - Concealed Cantilever Bracket
- SCWBKT1 & 2 - Worksurface bracket, "L" shaped, used to attach top panels, storage and pedestals
- CP-1 - Clamp Plate
- SPTR48-66 - Worksurface Straightener, 4 sizes: 48", 54", 60" and 66"

Worksurface support panels, bases & legs

These consist of the following models:

- 6-2112SP, 6-2812SP and 6-2818SP - End Support Panel
- 6-2112SB, 6-2812SB and 6-2818SB - "T" Support Base
- 6-2812WPS - Wall Panel Support
- 6-N162OLWA-36LWA - Left Wing End Assembly, 6 sizes: 20", 22", 28", 30", 34" and 36"
- 6-N162ORWA-36RWA - Right Wing End Assembly, 6 sizes: 20", 22", 28", 30", 34" and 36"
- 6-2122MEP and 6-2822MEP - End Panel
- 6-2122TEP-2836TEP - End Panel for peninsula Tables, 4 sizes: 21x22, 28x22, 28x30 and 28x36.
- 6-L2S - 2" Metal Square Support base, worksurface height only.
- SQB-29 - Desk Height Square Column Base
- 6-PBASE - End Support for Peninsula Top
- 6-22HBA2, 6-30HBA2 and 6-36HBA1 - H Leg Supports
(Also HBPA's with panel inserts)
- 6-22OBA2, 6-30OBA2 and 6-36OBA1 - O Leg Supports
(Also OBPA's with panel inserts)
- MBAR-42-78 - Leg Support Bar, 7 sizes: 42", 48", 54", 60", 66", 72" and 78".
- 6-TSP-10/9.5-32/9.5 - Riser Support Panels, P-Shape, Sizes: 10", 18", 26" and 32"
- 6-RSP-10/9.5-32/9.5 - Riser Support Panels, T-Shape, Sizes: 10", 18", 26" and 32"
- ASX32T - X-Base used with 36" round surface only

Adjustable height bases

These consist of the following models:

- HAxxxxCP - Center Column Pneumatic Base kit, Sizes: 48x20, 48x24, 48x30, 60x20, 60x24, 60x30, 72x20, 72x24 and 72x30
(xxxx in model number is replaced with corresponding sizes listed).
- HAxxxxFP - Offset Column Pneumatic Base kit, Sizes: 48x20, 48x24, 48x30, 60x20, 60x24, 60x30, 72x20, 72x24 and 72x30
(xxxx in model number is replaced with corresponding sizes listed).
- HAxxCRE - Center Electric Rectangular Base kit, sizes: 20", 24" and 30"
(replace xx with size in model number)
- HAxxCSE - Center Electric Square Base kit, sizes: 20", 24" and 30"
(replace xx with size in model number)
- HAxxFRE - Offset Electric Rectangular Base kit, sizes: 20", 24" and 30"
(replace xx with size in model number)
- HAxxFSE - Offset Electric Square Base kit, sizes: 20", 24" and 30"
(replace xx with size in model number)

Support Rules for use with Wall Panels:

Rules for proper bracket supports with worksurfaces

The following scenarios are the standard practice for using the above mentioned brackets correctly to properly support the STAKS worksurfaces

- Worksurfaces that join to panels on the short end (22", 30" and 36" ends) shall have two WSBKTC brackets. One mounted 3" from the front edge of the surface to the front edge of the bracket. The second mounted 3" in from the end of the surface to the edge of the bracket. (Figure A)

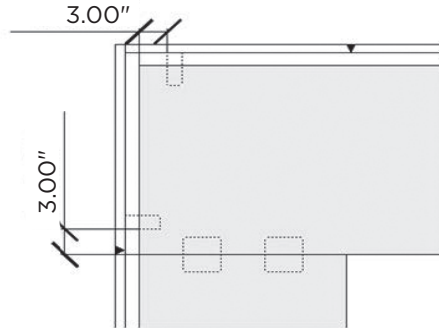

Figure A

- Span from one bracket or other form of support (pedestal, leg, bracket, etc.) shall not span more than 42" center to center of the supports being used. Standard OWSBKT brackets are used for these spans: 22 for the 22" deep surface, 30 for the 30" deep surface and 36 for the 36" deep.
- When two adjacent surfaces create a seam, those two surfaces will utilize the CP-1 Clamp Plates to secure them together.
 - Two plates for 22" deep surfaces, three plates for 30" and 36" seams. (Figure A)
 - These are not needed if a storage unit is spanning the seam of the surfaces, or if two storage units are used (one on each side of the seam).
 - If a storage pedestal is only used on one side of the seam, then an SCWBKT-1 bracket is mounted to the side of the pedestal, and the underside of the adjacent top in lieu of the CP-1 bracket. (Figure B)

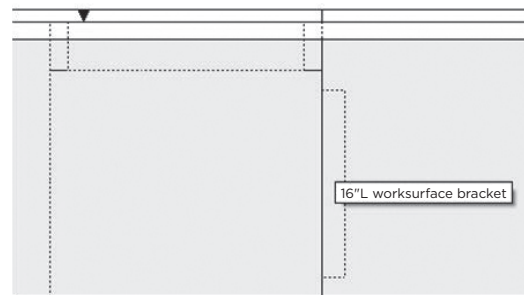

Figure B

- If desired, CP-1 brackets can be replaced with 6-L2S legs –this provides extra support at the seam and is most often used in longer spans where there are no pedestal supports being used.
- The "T" support bases (i.e. 6-2812SB) can be used at the seam of worksurfaces if desired. This would alleviate the need for one of the CP-1 Clamp Plates. This is NOT for use with Wall Panels. This support base should only be utilized if the surfaces are against a building wall or in an open space. (Freestanding)

Support Rules for use with Wall Panels:

- When a surface end adjacent to a storage tower a SCWBKT-1 bracket is used to secure the surface to the storage unit. (Figure C - pg 2)
 - **Note:** This does deface the side of the storage unit. If this is not desired, then a base, end panel or pedestal can be used to support the surface.
- When the end of a surface is mounted flush against a panel the SCWBKT-1 bracket can be used to support the end of the surface. This provides maximum support for the end of the surface without using a base. (Figure C)
- Maximum unsupported span for a panel is 24". Panels unsupported over that length should be attached to a worksurface using WSBKTC or a pedestal attaching directly to the panel (flush against the panel) or by using the pedestal to wall brackets. (Figure C)

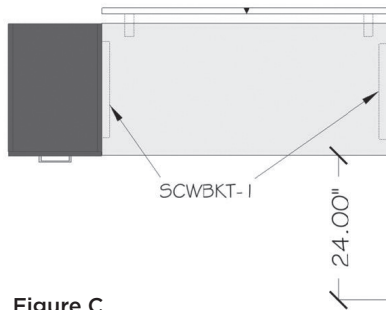

Figure C

- Brackets that attach to the wall panels should be mounted no closer than 3" to the edge/seam of panels.
 - **Note:** Mounting brackets on the seam could interfere with the clean-seam connectors and should be avoided at all times. Move the brackets 3" to the left or right of a seam in order to avoid mounting screws from hitting the clean seam connector screws.
- Brackets should not be mounted back-to-back, but instead be offset from one another by 2". This is to avoid weakening the core material and also to prevent the mounting screws from hitting each other. (Figure D)

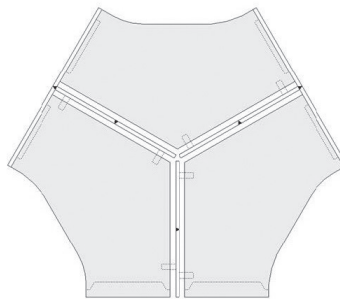

Figure D

- When creating a 120° layout the WSBKTC should be used to secure the worksurface and panels together. These brackets should be placed 3" from the ends of the panel to the edge of the bracket. Keep the brackets mounted on the same side of the panel, two are required for each panel/worksurface (Figure D)
 - The ends of a 120° station can be supported with support bases or by mounting flush against a panel by using the SCWBKT-1 bracket as mentioned above.
 - If a 'dogbone' type layout is being created, utilize the rules above concerning two adjacent surfaces creating a seam.
- Ends of surfaces that are open should be supported with one of the following options:
 - Support base or panel, i.e. 6-22HBA2. (Figure D)
 - Full depth pedestal with a finished back.

Support Rules for use with Wall Panels:

- When placing worksurfaces at different heights and overlapping them, one of the Riser Support Panels should be utilized. Height changes can be achieved as follows: (Figure E)
 - Worksurface Height (29") to Low-Height (23") with no above worksurface storage resting on the surface:
 - 6-RSP-18/9.5 - Used for 22" deep tops
 - Note:** that this riser support is also used to go from Low-Height (23") to Bench Height (17") as well. This option is only available with 22" deep surfaces.
 - 6-RSP-26/9.5 - Used for 30" deep tops
 - 6-RSP-32/9.5 - Used for 36" deep tops
 - These supports are placed with the long panel of the "P" running parallel to the end (depth) of the top they are supporting with the rectangular portion of the "P" extending toward the end of the surface.

Worksurface height to low-height with above worksurface storage resting directly on the worksurface:

- 6-TSP-18/9.5 - Used for 22" deep tops
- Note that this riser support is also used to go from Low-height (23") to Bench height (17") as well. This option is only available with 22" deep surfaces.
- 6-TSP-26/9.5 - Used for 30" deep tops
- 6-TSP-32/9.5 - Used for 36" deep tops
- These supports are placed with the top of the "T" running parallel to the end (depth) of the top they are supporting, with the leg of the "T" extending toward the end of the surface.



Figure E

- When mounting a half round worksurface at the end of a run the surface will require two 6-L2S legs as well as supporting the seams as described previously. (Figure F, upper left of unit)
 - The leg should be mounted 10" from the seam to the center of the legs, and 11" from the ends to the center of the leg.
 - If the adjacent surfaces are supported by storage, only a single leg is required. This would be located 11" in from the edge of the surface to the center of the leg, and centered on the radius (24" from both sides) to the center of the leg. (Figure F, lower right of unit)

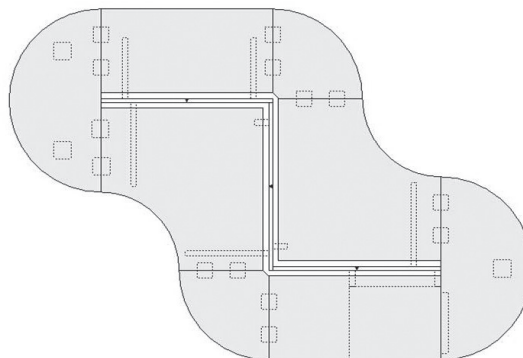

Figure F

Support Rules for use with Wall Panels:

- Corner unit worksurfaces that are being used in conjunction with wall panels require the following supports:
 - The back corner of the worksurface is supported with a WSBKTC mounted 3" in from the end of the surface to the end of the bracket. (Figure F)
 - Both ends of the corner unit should have OWSBKT22 brackets mounted in 3" from the end of the surface to the edge of the bracket.
 - The ends of the worksurface can be supported with H-Legs, O-Legs or End Panels if desired, however the panel will still need to be connected to the worksurface to stabilize the wall panel itself. This can be achieved using the Mini-Conceal (WSBKTC) instead of a full cantilever bracket.
- Quarter round surfaces should be supported with CP-1 clamp plates on both seams. (Figure F)
- When placing bench-height storage next to an otherwise unsupported wall panel, the storage will mount flush to the wall panels and secure through the back of the storage into the wall panel. (Figure G)
 - An unsupported span over 48" must utilize the Worksurface Straighteners to support the surface and prevent bowing. These should be mounted 8" in from the front and back edges of the surface. (Figure G)
 - One straightener is needed for 22" deep tops.
 - Two straighteners are needed for 30" and 36" deep tops.

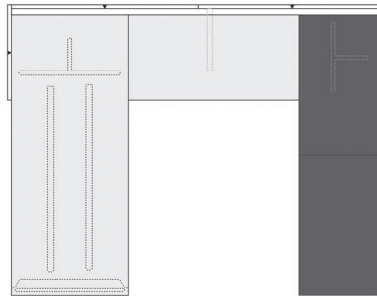

Figure G

- Pedestals placed at the end of a worksurface with panels should be full depth and have a finished back to clean up the aesthetics. A Mini-Conceal (WSBKTC) should be used to support the panel just to the inside of the pedestal. Maximum unsupported width of a wall panel extending beyond a support is 24". (Figure H)
- When utilizing the End Support Panels (SP model numbers) under a corner unit, two panels must be used and attached in an "L" configuration to prevent the panel from being 'kicked out' from under the surface. (Figure I, top left corner)
 - 6-2818SP supports 30" deep tops.
 - 6-2812SP and 6-2112SP support 22" deep tops.
 - If a back panel is being utilized in the layout connecting to this support panel, then a second SP panel is not necessary.
- The back panel will create the "L" support needed for the end panel. (Figure I, bottom right corner)

When utilizing an End Panel under the 22" deep surface a back panel or second support panel must be used and attached in an "L" configuration to prevent the end panel from being "kicked out" from under the surface.

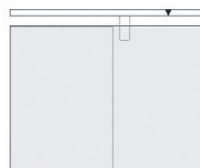

Figure H

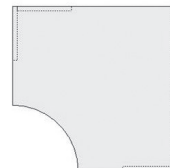

Figure I

Support Rules for Freestanding Applications:

Creating Private Office

The following are instructions for creating a private office using the freestanding supports.

- Wing End Assemblies are used to create a “desk” type look from the approach side of the unit. They are used on the ends of 22”, 30” and 36” tops.
- 36” and 34” wing ends can be used with 42” Bow tops, or 36” Rectilinear tops.
 - The 34” is actually 33 1/2” deep and leaves a 2 1/2” gap for wire management.
- 30” and 28” wing ends can be used with 36” bow tops or 30” Rectilinear tops.
 - The 28” is actually 27 1/2” deep and leaves a 2 1/2” gap for wire management.
 - 30” wing ends can be used with 36” rectilinear tops to leave an overhang on the approach side.
- 22” and 20” wing ends can be used with 22” deep rectilinear tops.
 - The 20” is actually 19 1/2” deep and leaves a 2 1/2” gap for wire management.
- Back panels or modesty panels are used between wing ends or wing end and storage. (Figure J)
 - Back panels are selected in range within 1/8” increments. Select the back support panel that falls within the range size desired. Back panel will be factory cut to the size you request.



Figure J

- H-Legs and O-Legs can be used in freestanding applications to support one or both ends of a top as desired.
 - **Note:** if the span between a single H or O base and an end panel, storage, or other support is over 48” a Worksurface Straightener will be required.
 - 22” Deep require one straightener, 30” and 36” deep tops require 2 straighteners.
 - Sizes range from 48” - 66” as listed above.
- If using two H or O leg’s, one on each end of the top, to create a table desk, the Leg Support Bar (MBAR-#) supports must be used to stabilize the table.
 - These must be used with a modesty panel.
 - Mbar stretches from leg-to-leg.
- If doing change of height from worksurface to low-height, or lowheight to benching height, the Riser Support panels can be utilized as noted in the support rules for use with Wall Panels.
- Pedestals provide support in freestanding applications. Users can select the depth of pedestal to match the wing end assemblies as listed above.
 - **Note:** that exposed backs of pedestals should be selected as Finished Back for aesthetics.
- Clamp plates, CP-1, are to be utilized as described in the support rules for use with Wall Panels.

Support Rules for Freestanding Applications:

- When using End Panels, 6-2122MEP and 6-2822MEP, a back panel or end support panel must be attached to create an 'L' to prevent the end panel from getting 'kicked out'.
 - Back panels used are selected in ranges within 1/8" increments. Select the panel model where the size desired falls in that model number's size range. Panel will be factory cut to the size requested.
- **Note:** that Fold-Down back panels can also be used
- If using another support to create an 'L', be sure to order the same height panel.
- Peninsula Table End Panels do not require a second 'L' support. These panels come with 2 drop brackets, angle brackets that attach to the top and end panel to prevent the end from getting kicked out.
- 6-PBASE Peninsula Base should be utilized at the end of a peninsula: P-Top, Bullet Top, etc. Base should be centered on the round portion of the P or Bullet top. (Figure K)

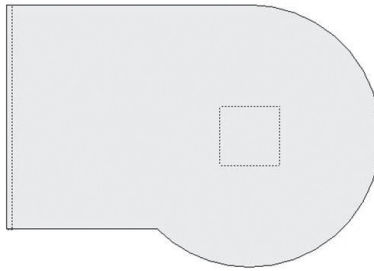

Figure K